

This operation manual is intended for users with basic knowledge of electricity and electric devices.

* LSLV-S100 is the official name for S100.

Safety Information

Read and follow all safety instructions in this manual precisely to avoid unsafe operating conditions, property damage, personal injury, or death.

Safety symbols in this manual

Danger

Indicates an imminently hazardous situation which, if not avoided, will result in severe injury or death.

Warning

Indicates a potentially hazardous situation which, if not avoided, could result in injury or death.

Caution

Indicates a potentially hazardous situation that, if not avoided, could result in minor injury or property damage.

Safety information

Danger

- Do not open the cover of the equipment while it is on or operating. Likewise, do not operate the inverter while the cover is open. Exposure of high voltage terminals or charging area to the external environment may result in an electric shock. Do not remove any covers or touch the internal circuit boards (PCBs) or electrical contacts on the product when the power is on or during operation. Doing so may result in serious injury, death, or serious property damage.
- Do not open the cover of the equipment even when the power supply to the inverter has been turned off unless it is necessary for maintenance or regular inspection. Opening the cover may result in an electric shock even when the power supply is off.
- The equipment may hold charge long after the power supply has been turned off. Use a multi-meter to make sure that there is no voltage before working on the inverter, motor or motor cable.

 **Warning**

- This equipment must be grounded for safe and proper operation.
- Do not supply power to a faulty inverter. If you find that the inverter is faulty, disconnect the power supply and have the inverter professionally repaired.
- The inverter becomes hot during operation. Avoid touching the inverter until it has cooled to avoid burns.
- Do not allow foreign objects, such as screws, metal chips, debris, water, or oil to get inside the inverter. Allowing foreign objects inside the inverter may cause the inverter to malfunction or result in a fire.
- Do not operate the inverter with wet hands. Doing so may result in electric shock.
- Check the information about the protection level for the circuits and devices.

The following connection terminals and devices are the Electrical Protection level 0. It means that the circuit protection level depends on the basic insulation. If there is no basic insulation is failed, it may cause electric shock accident. When installing or wiring the connection terminals and devices, take the same protective action as with the power wire.

- Multi-function Input: P1-P7, CM
- Analog Frequency Input: VR, V1, I2, T1
- Safety Function: SA, SB, SC
- Analog Output: AO, TO
- Contact: Q1, EG, 24, A1, B1, C1, S+, S-, SG
- Fan

- The protection level of this equipment (inverter) is the Electrical Protection level I.

⚠ Caution

- Do not modify the interior workings of the inverter. Doing so will void the warranty.
- The inverter is designed for 3-phase motor operation. Do not use the inverter to operate a single phase motor.
- Do not place heavy objects on top of electric cables. Doing so may damage the cable and result in an electric shock.

Note

Maximum allowed prospective short-circuit current at the input power connection is defined in IEC 60439-1 as 100 kA. Depending on the selected MCCB, the LSLV-S100 Series is suitable for use in circuits capable of delivering a maximum of 100 kA RMS symmetrical amperes at the drive's maximum rated voltage. The following table shows the recommended MCCB for RMS symmetrical amperes.

Remarque

Le courant maximum de court-circuit présumé autorisé au connecteur d'alimentation électrique est défini dans la norme IEC 60439-1 comme égal à 100 kA. Selon le MCCB sélectionné, la série LSLV-S100 peut être utilisée sur des circuits pouvant fournir un courant RMS symétrique de 100 kA maximum en ampères à la tension nominale maximale du variateur. Le tableau suivant indique le MCCB recommandé selon le courant RMS symétrique en ampères.

| Working Voltage | UTE100(E/N) | UTS150(N/H/L) | ABS33c | ABS53c | ABS63c | ABS103c |
|-----------------|-------------|---------------|--------|--------|--------|---------|
| 240V(50/60Hz) | 50/65 kA | 65/100/150 kA | 30 kA | 35 kA | 35 kA | 85 kA |
| 480V(50/60Hz) | 25/35 kA | 35/65/100 kA | 7.5 kA | 10 kA | 10 kA | 26 kA |

Quick Reference Table

The following table contains situations frequently encountered by users while working with inverters. Refer to the typical and practical situations in the table to quickly and easily locate answers to your questions.

| Situation | Reference |
|---|--------------------------------------|
| I want to run a slightly higher rated motor than the inverter's rated capacity. | <u>p. 198</u> |
| I want to configure the inverter to start operating as soon as the power source is applied. | <u>p. 85</u> |
| I want to configure the motor's parameters. | <u>p.144</u> |
| I want to set up sensorless vector control. | <u>p.147</u> |
| Something seems to be wrong with the inverter or the motor. | <u>p. 216, p.327</u> |
| What is auto tuning? | <u>p.144</u> |
| What are the recommended wiring lengths? | <u>p. 216, p.327</u> |
| The motor is too noisy. | <u>p. 165</u> |
| I want to apply PID control on my system. | <u>p. 136</u> |
| What are the factory default settings for P1-P7 multi-function terminals? | <u>p. 30</u> |
| I want to view all of the parameters I have modified. | <u>p. 174</u> |
| I want to review recent fault trip and warning histories. | <u>p. 292</u> |
| I want to change the inverter's operation frequency using a potentiometer. | <u>p. 57</u> |
| I want to install a frequency meter using an analog terminal. | <u>p. 31</u> |
| I want to display the supply current to motor. | <u>p. 60</u> |
| I want to operate the inverter using a multi-step speed configuration. | <u>p. 77</u> |
| The motor runs too hot. | <u>p. 197</u> |
| The inverter is too hot. | <u>p. 205</u> |
| The cooling fan does not work. | <u>p. 333</u> |
| I want to change the items that are monitored on the keypad. | <u>p. 193</u> |

Table of Contents

| | | |
|----------|---|-----------|
| 1 | Preparing the Installation | 1 |
| 1.1 | Product Identification..... | 1 |
| 1.2 | Part Names..... | 3 |
| 1.3 | Installation Considerations..... | 5 |
| 1.4 | Selecting and Preparing a Site for Installation..... | 6 |
| 1.5 | Cable Selection..... | 10 |
| 2 | Installing the Inverter | 13 |
| 2.1 | Mounting the Inverter | 15 |
| 2.2 | Cable Wiring..... | 19 |
| 2.3 | Post-Installation Checklist..... | 38 |
| 2.4 | Test Run | 39 |
| 3 | Learning to Perform Basic Operations | 43 |
| 3.1 | About the Keypad..... | 43 |
| 3.1.1 | About the Display..... | 44 |
| 3.1.2 | Operation Keys..... | 45 |
| 3.1.3 | Control Menu..... | 46 |
| 3.2 | Learning to Use the Keypad..... | 47 |
| 3.2.1 | Group and Code Selection..... | 47 |
| 3.2.2 | Navigating Directly to Different Codes..... | 48 |
| 3.2.3 | Setting Parameter Values..... | 49 |
| 3.2.4 | Configuring the [ESC] Key..... | 50 |
| 3.3 | Actual Application Examples | 51 |
| 3.3.1 | Acceleration Time Configuration..... | 51 |
| 3.3.2 | Frequency Reference Configuration..... | 52 |
| 3.3.3 | Jog Frequency Configuration..... | 54 |
| 3.3.4 | Initializing All Parameters..... | 54 |
| 3.3.5 | Frequency Setting (Keypad) and Operation (via Terminal Input) | 56 |
| 3.3.6 | Frequency Setting (Potentiometer) and Operation (Terminal Input) | 57 |
| 3.3.7 | Frequency Setting (Potentiometer) and Operation (Keypad) | 58 |

| | | |
|----------|--|-----------|
| 3.4 | Monitoring the Operation | 60 |
| 3.4.1 | Output Current Monitoring..... | 60 |
| 3.4.2 | Fault Trip Monitoring..... | 61 |
| 4 | Learning Basic Features..... | 63 |
| 4.1 | Setting Frequency Reference..... | 66 |
| 4.1.1 | Keypad as the Source (KeyPad-1 setting)..... | 66 |
| 4.1.2 | Keypad as the Source (KeyPad-2 setting)..... | 66 |
| 4.1.3 | V1 Terminal as the Source..... | 67 |
| 4.1.4 | Setting a Frequency Reference with Input Voltage (Terminal I2)..... | 74 |
| 4.1.5 | Setting a Frequency with TI Pulse Input..... | 74 |
| 4.1.6 | Setting a Frequency Reference via RS-485 Communication..... | 76 |
| 4.2 | Frequency Hold by Analog Input..... | 77 |
| 4.3 | Changing the Displayed Units (Hz↔Rpm)..... | 77 |
| 4.4 | Setting Multi-step Frequency | 77 |
| 4.5 | Command Source Configuration..... | 80 |
| 4.5.1 | The Keypad as a Command Input Device..... | 80 |
| 4.5.2 | Terminal Block as a Command Input Device (Fwd/Rev Run Commands)..... | 80 |
| 4.5.3 | Terminal Block as a Command Input Device (Run and Rotation Direction Commands)..... | 81 |
| 4.5.4 | RS-485 Communication as a Command Input Device..... | 82 |
| 4.6 | Local/Remote Mode Switching..... | 82 |
| 4.7 | Forward or Reverse Run Prevention | 84 |
| 4.8 | Power-on Run..... | 85 |
| 4.9 | Reset and Restart..... | 85 |
| 4.10 | Setting Acceleration and Deceleration Times..... | 87 |
| 4.10.1 | Acc/Dec Time Based on Maximum Frequency..... | 87 |
| 4.10.2 | Acc/Dec Time Based on Operation Frequency..... | 88 |
| 4.10.3 | Multi-step Acc/Dec Time Configuration..... | 89 |
| 4.10.4 | Configuring Acc/Dec Time Switch Frequency | 91 |
| 4.11 | Acc/Dec Pattern Configuration | 91 |
| 4.12 | Stopping the Acc/Dec Operation..... | 94 |

| | | |
|----------|--|------------|
| 4.13 | V/F(Voltage/Frequency) Control | 94 |
| 4.13.1 | Linear V/F Pattern Operation..... | 94 |
| 4.13.2 | Square Reduction V/F pattern Operation..... | 95 |
| 4.13.3 | User V/F Pattern Operation | 96 |
| 4.14 | Torque Boost..... | 97 |
| 4.14.1 | Manual Torque Boost | 97 |
| 4.14.2 | Auto Torque Boost-1..... | 98 |
| 4.14.3 | Auto Torque Boost-2..... | 99 |
| 4.15 | Output Voltage Setting | 99 |
| 4.16 | Start Mode Setting..... | 100 |
| 4.16.1 | Acceleration Start..... | 100 |
| 4.16.2 | Start After DC Braking..... | 100 |
| 4.17 | Stop Mode Setting..... | 101 |
| 4.17.1 | Deceleration Stop | 101 |
| 4.17.2 | Stop After DC Braking..... | 101 |
| 4.17.3 | Free Run Stop..... | 102 |
| 4.17.4 | Power Braking..... | 103 |
| 4.18 | Frequency Limit..... | 104 |
| 4.18.1 | Frequency Limit Using Maximum Frequency and Start Frequency | 104 |
| 4.18.2 | Frequency Limit Using Upper and Lower Limit Frequency Values | 104 |
| 4.18.3 | Frequency Jump..... | 105 |
| 4.19 | 2 nd Operation Mode Setting..... | 106 |
| 4.20 | Multi-function Input Terminal Control | 107 |
| 4.21 | P2P Setting..... | 109 |
| 4.22 | Multi-keypad Setting..... | 110 |
| 4.23 | User Sequence Setting | 111 |
| 4.24 | Fire Mode Operation | 117 |
| 5 | Learning Advanced Features..... | 121 |
| 5.1 | Operating with Auxiliary References..... | 122 |
| 5.2 | Jog operation | 126 |
| 5.2.1 | Jog Operation 1-Forward Jog by Multi-function Terminal | 126 |

| | | |
|--------|---|-----|
| 5.2.2 | Jog Operation 2-Fwd/Rev Jog by Multi-function Terminal | 128 |
| 5.2.3 | Jog Operation by Keypad | 128 |
| 5.3 | Up-down Operation | 129 |
| 5.4 | 3-Wire Operation | 130 |
| 5.5 | Safe Operation Mode | 131 |
| 5.6 | Dwell Operation | 133 |
| 5.7 | Slip Compensation Operation | 134 |
| 5.8 | PID Control | 136 |
| 5.8.1 | PID Basic Operation | 136 |
| 5.8.2 | Pre-PID Operation | 142 |
| 5.8.3 | PID Operation Sleep Mode | 142 |
| 5.8.4 | PID Switching (PID Openloop) | 143 |
| 5.9 | Auto Tuning | 144 |
| 5.10 | Sensorless Vector Control | 147 |
| 5.10.1 | Sensorless Vector Control Operation Setting | 149 |
| 5.10.2 | Sensorless Vector Control Operation Guide | 152 |
| 5.11 | Kinetic Energy Buffering Operation | 154 |
| 5.12 | Torque Control | 156 |
| 5.13 | Energy Saving Operation | 159 |
| 5.13.1 | Manual Energy Saving Operation | 159 |
| 5.13.2 | Automatic Energy Saving Operation | 160 |
| 5.14 | Speed Search Operation | 160 |
| 5.15 | Auto Restart Settings | 164 |
| 5.16 | Operational Noise Settings (carrier frequency settings) | 165 |
| 5.17 | 2 nd Motor Operation | 167 |
| 5.18 | Supply Power Transition | 168 |
| 5.19 | Cooling Fan Control | 169 |
| 5.20 | Input Power Frequency and Voltage Settings | 170 |
| 5.21 | Read, Write, and Save Parameters | 171 |
| 5.22 | Parameter Initialization | 171 |
| 5.23 | Parameter View Lock | 172 |
| 5.24 | Parameter Lock | 173 |

| | | |
|----------|--|------------|
| 5.25 | Changed Parameter Display | 174 |
| 5.26 | User Group | 174 |
| 5.27 | Easy Start On | 176 |
| 5.28 | Config(CNF) Mode | 177 |
| 5.29 | Timer Settings | 178 |
| 5.30 | Brake Control | 179 |
| 5.31 | Multi-Function Output On/Off Control | 180 |
| 5.32 | Press Regeneration Prevention | 181 |
| 5.33 | Analog Output..... | 182 |
| 5.33.1 | Voltage and Current Analog Output..... | 182 |
| 5.33.2 | Analog Pulse Output..... | 185 |
| 5.34 | Digital Output | 187 |
| 5.34.1 | Multi-function Output Terminal and Relay Settings | 187 |
| 5.34.2 | Fault Trip Output using Multi-Function Output Terminal and Relay | 191 |
| 5.34.3 | Multi-function Output Terminal Delay Time Settings | 192 |
| 5.35 | Keypad Language Settings | 193 |
| 5.36 | Operation State Monitor | 193 |
| 5.37 | Operation Time Monitor | 196 |
| 6 | Learning Protection Features..... | 197 |
| 6.1 | Motor Protection | 197 |
| 6.1.1 | Electronic Thermal Motor Overheating Prevention (ETH) | 197 |
| 6.1.2 | Overload Early Warning and Trip | 198 |
| 6.1.3 | Stall Prevention and Flux Braking | 200 |
| 6.2 | Inverter and Sequence Protection..... | 203 |
| 6.2.1 | Open-phase Protection | 203 |
| 6.2.2 | External Trip Signal | 204 |
| 6.2.3 | Inverter Overload Protection | 205 |
| 6.2.4 | Speed Command Loss | 206 |
| 6.2.5 | Dynamic Braking (DB) Resistor Configuration | 208 |
| 6.3 | Under load Fault Trip and Warning..... | 209 |
| 6.3.1 | Fan Fault Detection | 211 |

| | | |
|----------|--|------------|
| 6.3.2 | Lifetime diagnosis of components | 211 |
| 6.3.3 | Low Voltage Fault Trip..... | 213 |
| 6.3.4 | Output Block by Multi-Function Terminal | 214 |
| 6.3.5 | Trip Status Reset..... | 214 |
| 6.3.6 | Inverter Diagnosis State..... | 215 |
| 6.3.7 | Operation Mode on Option Card Trip | 215 |
| 6.3.8 | No Motor Trip | 216 |
| 6.3.9 | Low voltage trip 2 | 216 |
| 6.4 | Fault/Warning List | 216 |
| 7 | RS-485 Communication Features | 219 |
| 7.1 | Communication Standards | 219 |
| 7.2 | Communication System Configuration..... | 219 |
| 7.2.1 | Communication Line Connection..... | 220 |
| 7.2.2 | Setting Communication Parameters | 220 |
| 7.2.3 | Setting Operation Command and Frequency | 222 |
| 7.2.4 | Command Loss Protective Operation | 223 |
| 7.2.5 | Setting Virtual Multi-Function Input | 223 |
| 7.2.6 | Saving Parameters Defined by Communication | 224 |
| 7.2.7 | Total Memory Map for Communication | 225 |
| 7.2.8 | Parameter Group for Data Transmission | 225 |
| 7.3 | Communication Protocol..... | 226 |
| 7.3.1 | LS INV 485 Protocol | 226 |
| 7.3.2 | Modbus-RTU Protocol | 232 |
| 7.4 | Compatible Common Area Parameter..... | 235 |
| 7.5 | S100 Expansion Common Area Parameter | 238 |
| 7.5.1 | Monitoring Area Parameter (Read Only)..... | 238 |
| 7.5.2 | Control Area Parameter (Read/ Write)..... | 243 |
| 7.5.3 | Inverter Memory Control Area Parameter (Read and Write)..... | 245 |
| 8 | Table of Functions | 249 |
| 8.1 | Operation Group | 249 |
| 8.2 | Drive group (PAR→dr) | 251 |
| 8.3 | Basic Function group (PAR→bA)..... | 256 |

| | | |
|-----------|--|------------|
| 8.4 | Expanded Function group (PAR→Ad)..... | 261 |
| 8.5 | Control Function group (PAR→Cn)..... | 266 |
| 8.6 | Input Terminal Block Function group (PAR→In)..... | 271 |
| 8.7 | Output Terminal Block Function group (PAR→OU)..... | 276 |
| 8.8 | Communication Function group (PAR→CM) | 280 |
| 8.9 | Application Function group (PAR→AP)..... | 285 |
| 8.10 | Protection Function group (PAR→Pr)..... | 288 |
| 8.11 | 2nd Motor Function group (PAR→M2)..... | 293 |
| 8.12 | User Sequence group (US)..... | 295 |
| 8.13 | User Sequence Function group(UF) | 298 |
| 8.14 | Groups for LCD Keypad Only..... | 319 |
| 8.14.1 | Trip Mode (TRP Last-x)..... | 319 |
| 8.14.2 | Config Mode (CNF)..... | 319 |
| 9 | Troubleshooting | 323 |
| 9.1 | Trips and Warnings | 323 |
| 9.1.1 | Fault Trips | 323 |
| 9.1.2 | Warning Messages | 326 |
| 9.2 | Troubleshooting Fault Trips..... | 327 |
| 9.3 | Troubleshooting Other Faults..... | 329 |
| 10 | Maintenance..... | 335 |
| 10.1 | Regular Inspection Lists | 335 |
| 10.1.1 | Daily Inspections | 335 |
| 10.1.2 | Annual Inspections | 336 |
| 10.1.3 | Bi-annual Inspections | 338 |
| 10.2 | Storage and Disposal..... | 338 |
| 10.2.1 | Storage | 338 |
| 10.2.2 | Disposal..... | 339 |
| 11 | Technical Specification | 341 |
| 11.1 | Input and Output Specification | 341 |
| 11.2 | Product Specification Details | 347 |
| 11.3 | External Dimensions (IP 20 Type) | 349 |

| | | |
|-----------|--|------------|
| 11.4 | Peripheral Devices..... | 355 |
| 11.5 | Fuse and Reactor Specifications | 356 |
| 11.6 | Terminal Screw Specification..... | 357 |
| 11.7 | Braking Resistor Specification | 359 |
| 11.8 | Continuous Rated Current Derating..... | 360 |
| 11.9 | Heat Emmission | 362 |
| 12 | Applying Drives to Single-Phase Input Application | 363 |
| 12.1 | Introduction | 363 |
| 12.2 | Power(HP), Input Current and Output Current | 364 |
| 12.3 | Input Frequency and Voltage Tolerance..... | 365 |
| | Product Warranty | 367 |
| | Index | 375 |

1 Preparing the Installation

This chapter provides details on product identification, part names, correct installation and cable specifications. To install the inverter correctly and safely, carefully read and follow the instructions.

1.1 Product Identification

The S100 Inverter is manufactured in a range of product groups based on drive capacity and power source specifications. Product name and specifications are detailed on the rating plate. The illustration on the next page shows the location of the rating plate. Check the rating plate before installing the product and make sure that the product meets your requirements. For more detailed product specifications, refer to [*11.1 Input and Output Specification*](#) on page [*341*](#).

Note

Check the product name, open the packaging, and then confirm that the product is free from defects. Contact your supplier if you have any issues or questions about your product.

LSLV0055S100-4EOFNS

Model name

INPUT 380-480V 3 Phase 50/60Hz
HD: 11.0A, ND: 14.7A

Power source specifications

OUTPUT 0-Input V 3 Phase 0.01-400Hz
HD: 12A, ND: 16A
9.1kVA
Ser. No 55025310146
Inspected by D. K. YU

Output specifications

LSLV 0055 S100 - 4EOFNS

Motor capacity

| | |
|---------------|---------------|
| 0004 - 0.4KW | 0055 - 5.5KW |
| 0008 - 0.75KW | 0075 - 7.5KW |
| 0015 - 1.5KW | 0110 - 11KW |
| 0022 - 2.2KW | 0150 - 15KW |
| 0037 - 3.7KW | 0185 - 18.5KW |
| 0040 - 4.0KW | 0220 - 22KW |

Series name

Input voltage

- 1 - Single phase 200V
- 2 - 3-phase 200V
- 4 - 3-phase 400V

Keypad

- E - LED Keypad

UL Type

- O - UL Open Type

EMC filter

- F - Built-in EMC
- N - Non-EMC

Reactor

- N - Non-Reactor

I/O

- M - 3.5mm
- S - 5mm

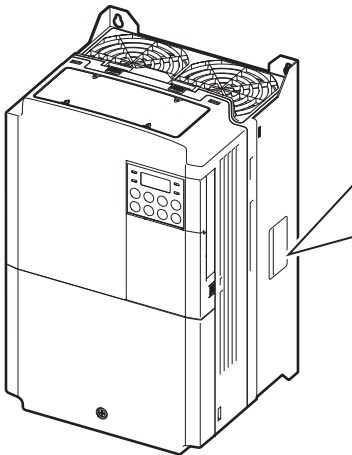

1.2 Part Names

The illustration below displays part names. Details may vary between product groups.

0.4~2.2kW (Single Phase) and 0.4~4.0kW (3-Phase)

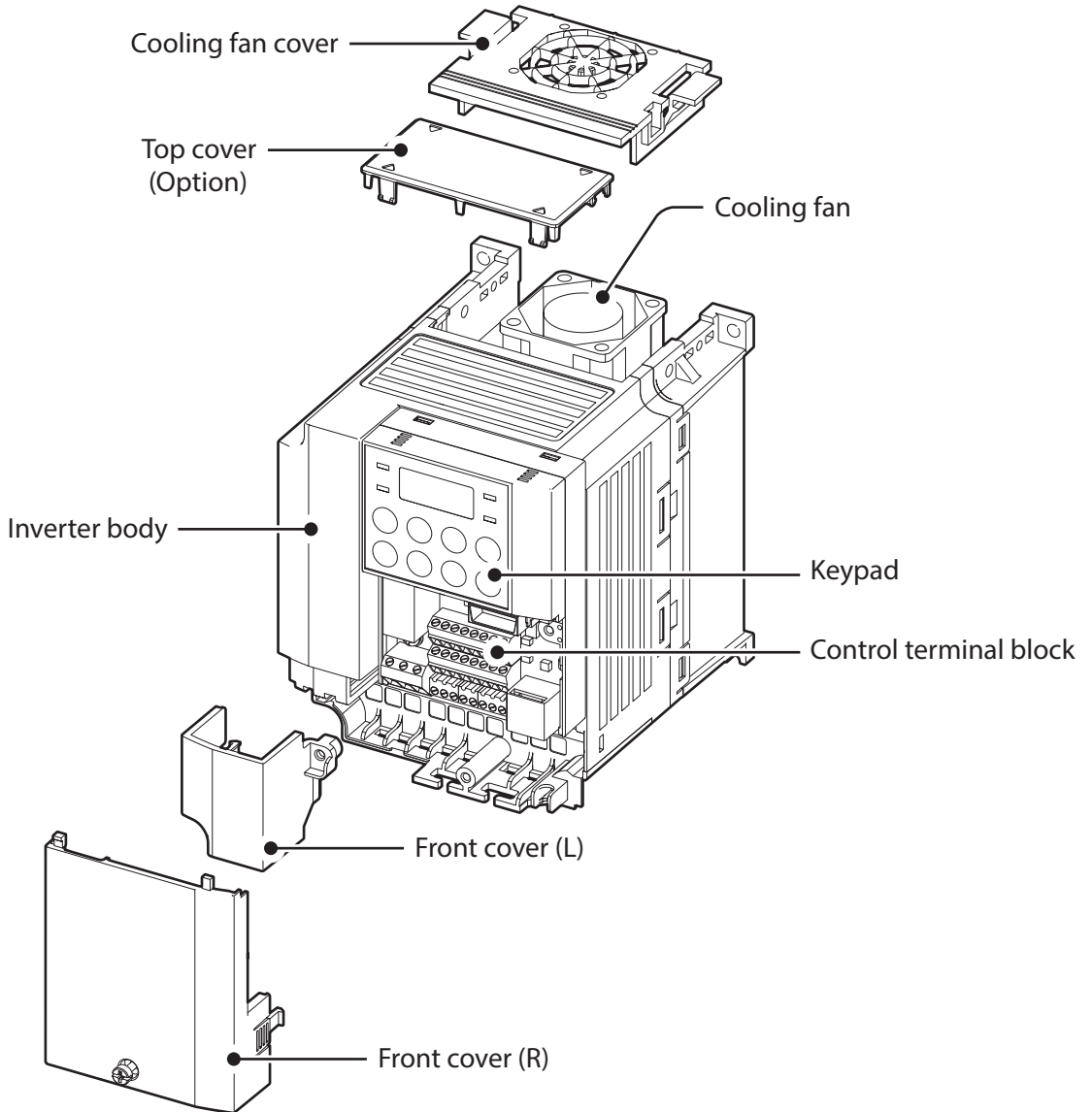

5.5-22kW(3-Phase)

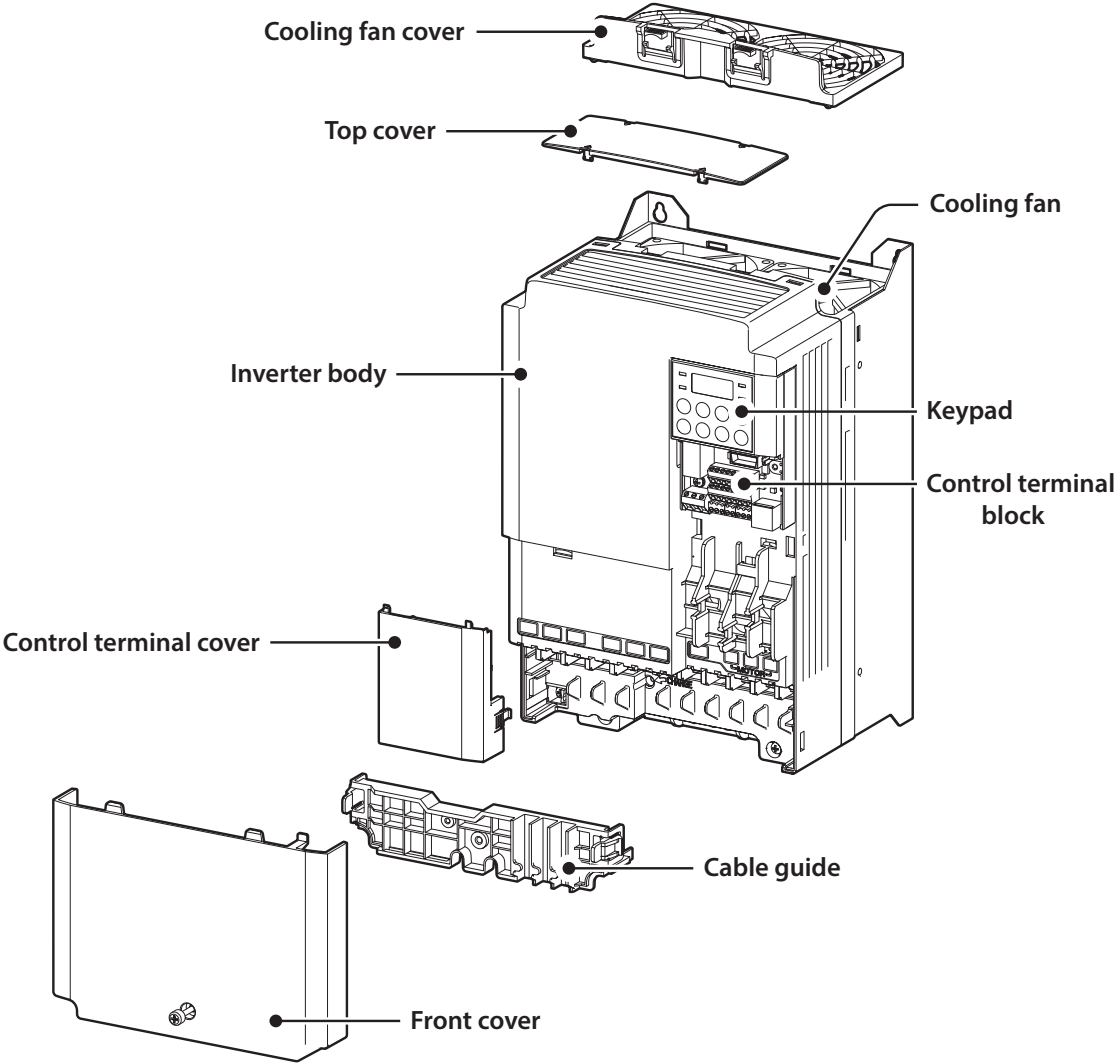

1.3 Installation Considerations

Inverters are composed of various precision, electronic devices, and therefore the installation environment can significantly impact the lifespan and reliability of the product. The table below details the ideal operation and installation conditions for the inverter.

| Items | Description |
|-----------------------|---|
| Ambient Temperature* | Heavy Duty: 14–104°F (-10–50°C) Normal Duty: 14–122°F (-10– 40°C) |
| Ambient Humidity | 90% relative humidity (no condensation) |
| Storage Temperature | - 4–149°F (-20–65°C) |
| Environmental Factors | An environment free from corrosive or flammable gases, oil residue or dust |
| Altitude/Vibration | Lower than 3,280 ft (1,000 m) above sea level/less than 1G (9.8m/sec ²) |
| Air Pressure | 70 –106kPa |

* The ambient temperature is the temperature measured at a point 2" (5 cm) from the surface of the inverter.

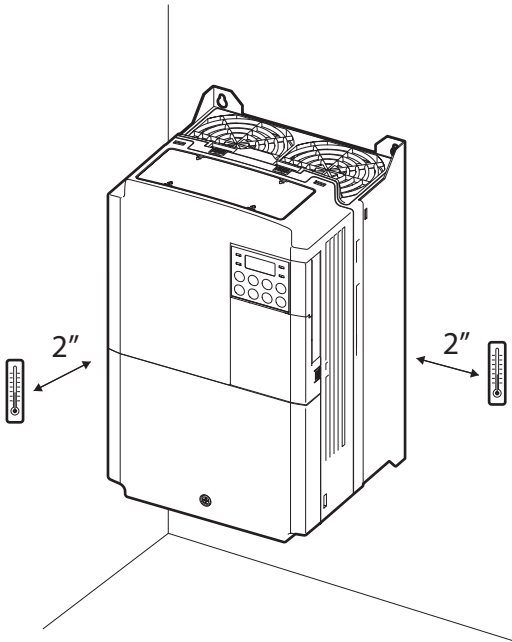

⚠ Caution

Do not allow the ambient temperature to exceed the allowable range while operating the inverter.

1.4 Selecting and Preparing a Site for Installation

When selecting an installation location consider the following points:

- The inverter must be installed on a wall that can support the inverter's weight.
- The location must be free from vibration. Vibration can adversely affect the operation of the inverter.
- The inverter can become very hot during operation. Install the inverter on a surface that is fire-resistant or flame-retardant and with sufficient clearance around the inverter to allow air to circulate. The illustrations below detail the required installation clearances.

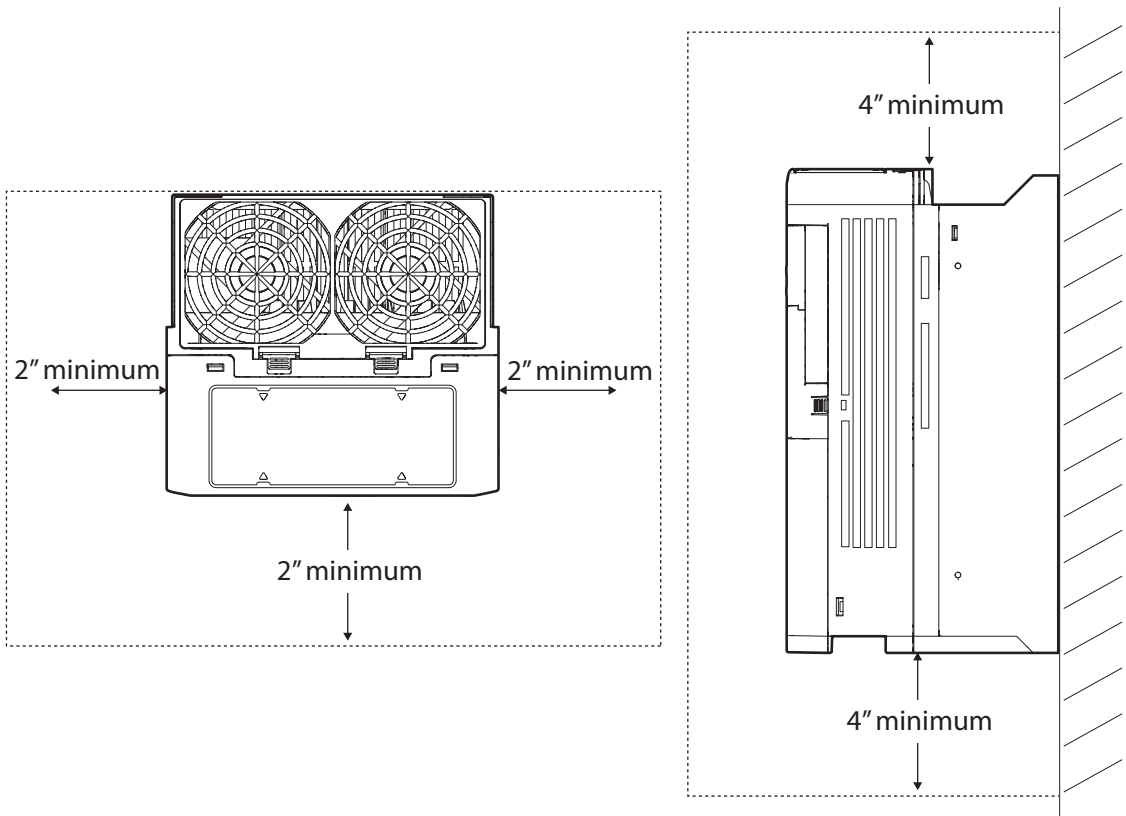

- Ensure sufficient air circulation is provided around the inverter when it is installed. If the inverter is to be installed inside a panel, enclosure, or cabinet rack, carefully consider the position of the inverter's cooling fan and the ventilation louver. The cooling fan must be positioned to efficiently transfer the heat generated by the operation of the inverter.

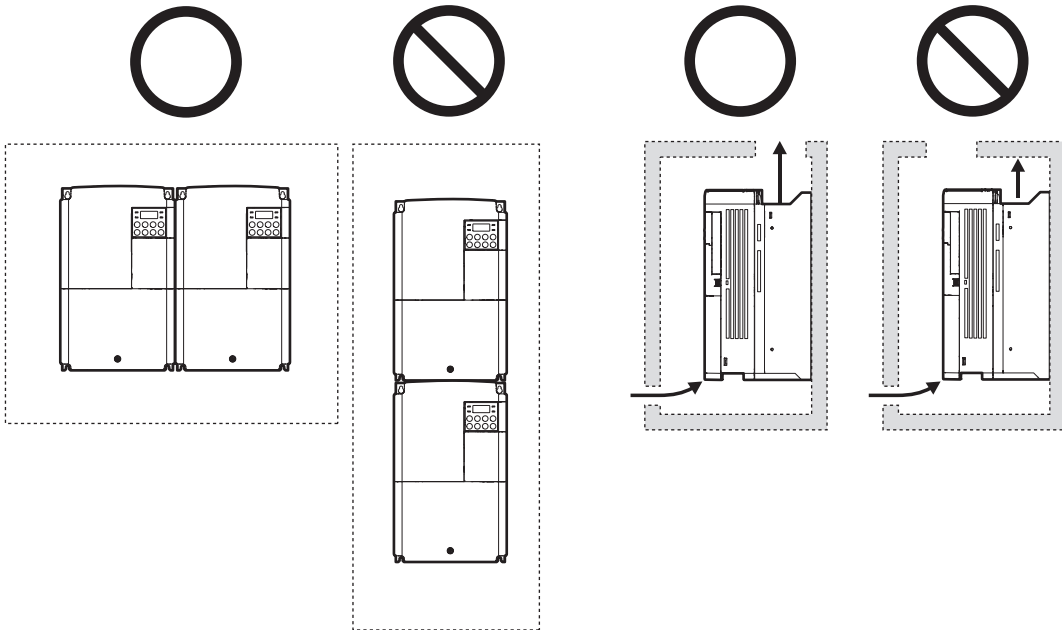

Preparing the Installation

- If you are installing multiple inverters in one location, arrange them side-by-side and remove the top covers. The top covers **MUST** be removed for side-by-side installations. Use a flat head screwdriver to remove the top covers.

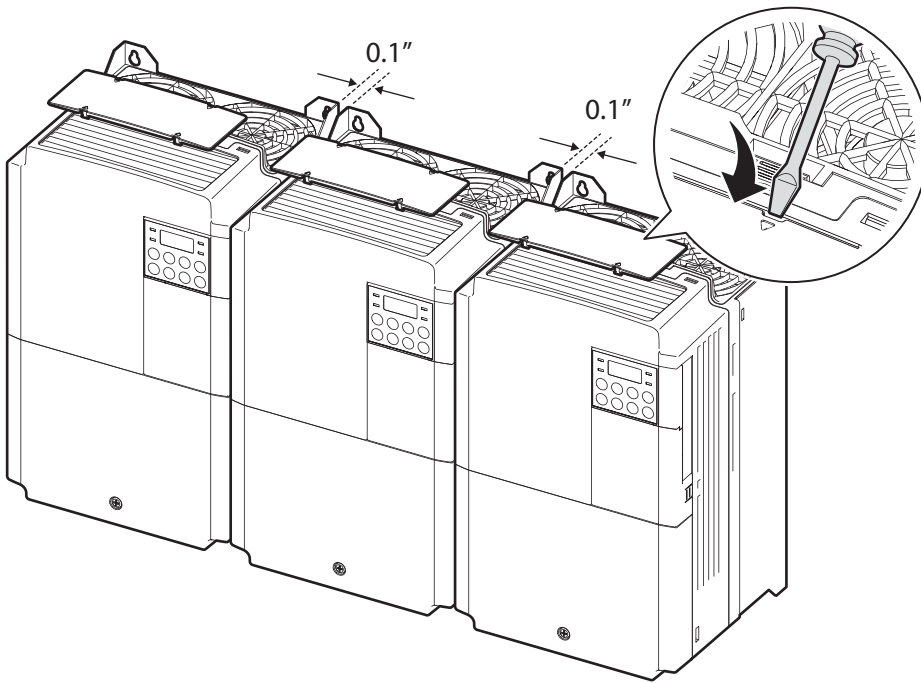

- If you are installing multiple inverters, of different ratings, provide sufficient clearance to meet the clearance specifications of the larger inverter.

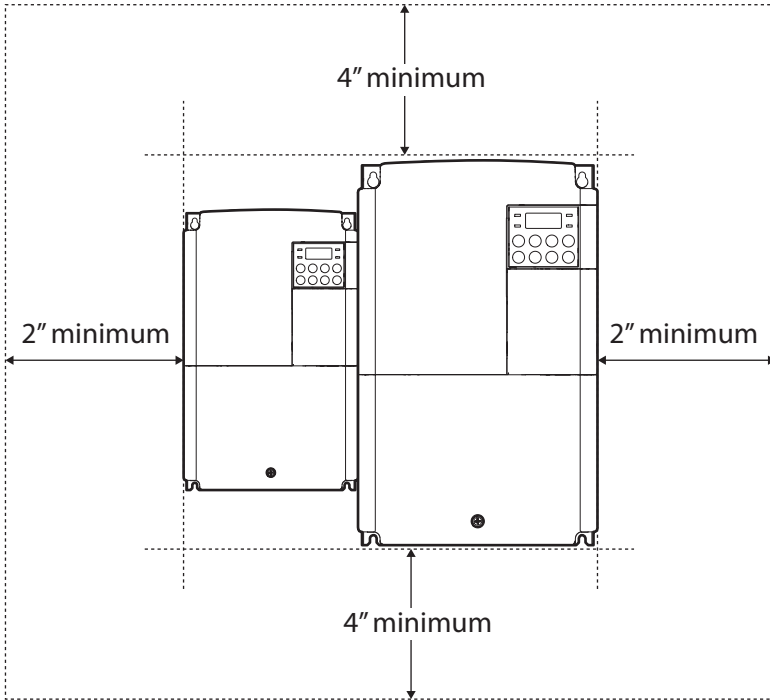

1.5 Cable Selection

When you install power and signal cables in the terminal blocks, only use cables that meet the required specification for the safe and reliable operation of the product. Refer to the following information to assist you with cable selection.

⚠ Caution

- Wherever possible use cables with the largest cross-sectional area for mains power wiring, to ensure that voltage drop does not exceed 2%.
- Use copper cables rated for 600V, 75°C for power terminal wiring.
- Use copper cables rated for 300V, 75°C for control terminal wiring.

Ground Cable and Power Cable Specifications

| Load (kW) | | Ground | | Power I/O | | | |
|----------------------|------|-----------------|-----|-----------------|-------|-------|-------|
| | | mm ² | AWG | mm ² | | AWG | |
| | | | | R/S/T | U/V/W | R/S/T | U/V/W |
| Single Phase 200V | 0.4 | 4 | 12 | 2 | 2 | 14 | 14 |
| | 0.75 | | | | | | |
| | 1.5 | | | 3.5 | 3.5 | 12 | 12 |
| | 2.2 | | | | | | |
| 3-Phase 200V | 0.4 | 4 | 12 | 2 | 2 | 14 | 14 |
| | 0.75 | | | | | | |
| | 1.5 | | | 3.5 | 3.5 | 12 | 12 |
| | 2.2 | | | | | | |
| | 3.7 | 5.5 | 10 | 6 | 6 | 10 | 10 |
| | 4 | | | | | | |
| | 5.5 | 14 | 6 | 10 | 10 | 8 | 8 |
| | 7.5 | | | | | | |
| | 11 | | | 16 | 16 | 6 | 6 |
| | 15 | | | | | | |
| 3-Phase 400V | 0.4 | 4 | 12 | 2 | 2 | 14 | 14 |
| | 0.75 | | | | | | |
| | 1.5 | | | | | | |
| | 2.2 | | | | | | |
| | 3.7 | | | | | | |
| | 4 | 4 | 12 | 2.5 | 2.5 | 14 | 14 |
| | 5.5 | | | | | | |
| | 7.5 | | | 8 | 8 | 4 | 4 |
| | 11 | | | | | | |
| | 15 | 14 | 6 | | | 6 | 6 |
| | 18.5 | | | | | | |
| 22 | | | | | | | |

Signal (Control) Cable Specifications

| Terminals | Signal Cable | | | |
|---|--|-----|--|-----|
| | Without Crimp Terminal Connectors (Bare wire) | | With Crimp Terminal Connectors (Bootlace Ferrule) | |
| | mm ² | AWG | mm ² | AWG |
| P1~P7*/CM/VR/V1/I2 /AO/Q1/EG/24/TI/TO* /SA,SB,SC/S+,S-,SG | 0.75 | 18 | 0.5 | 20 |
| A1/B1/C1 | 1.0 | 17 | 1.5 | 15 |

* Standard I/O doesn't support P6/P7/TI/TO terminal. Refer to [Step 4 Control Terminal Wiring](#) on page [27](#).

2 Installing the Inverter

This chapter describes the physical and electrical installation methods, including mounting and wiring of the product. Refer to the flowchart and basic configuration diagram provided below to understand the procedures and installation methods to be followed to install the product correctly.

Installation Flowchart

The flowchart lists the sequence to be followed during installation. The steps cover equipment installation and testing of the product. More information on each step is referenced in the steps.

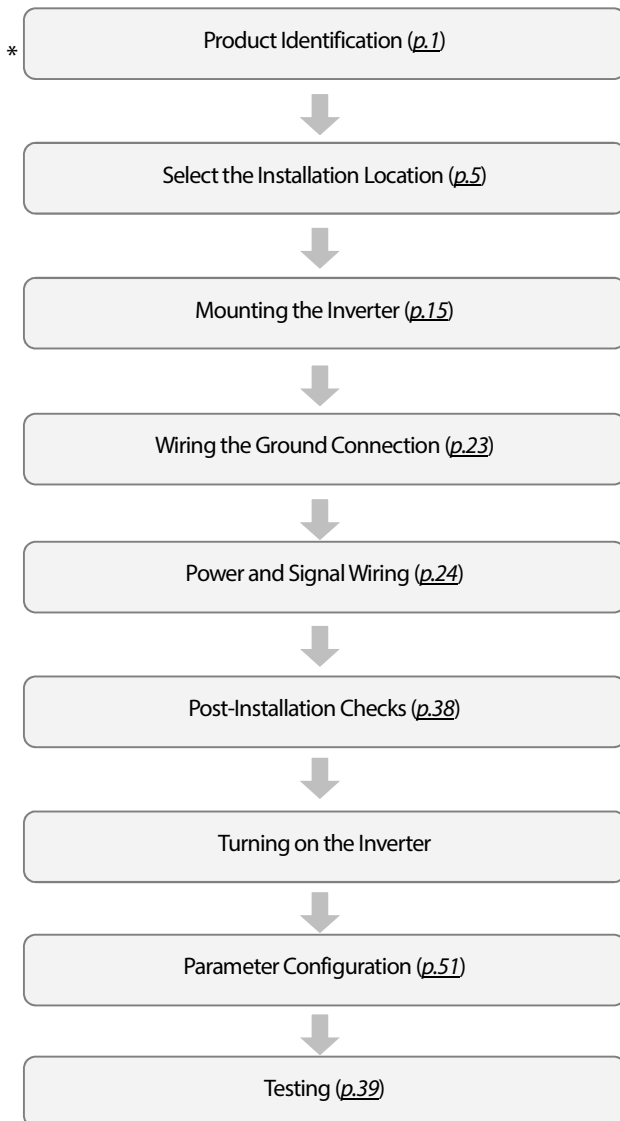

Basic Configuration Diagram

The reference diagram below shows a typical system configuration showing the inverter and peripheral devices.

Prior to installing the inverter, ensure that the product is suitable for the application (power rating, capacity, etc). Ensure that all of the required peripherals and optional devices (resistor brakes, contactors, noise filters, etc.) are available. For more details on peripheral devices, refer to [11.4 Peripheral Devices](#) on page [355](#).

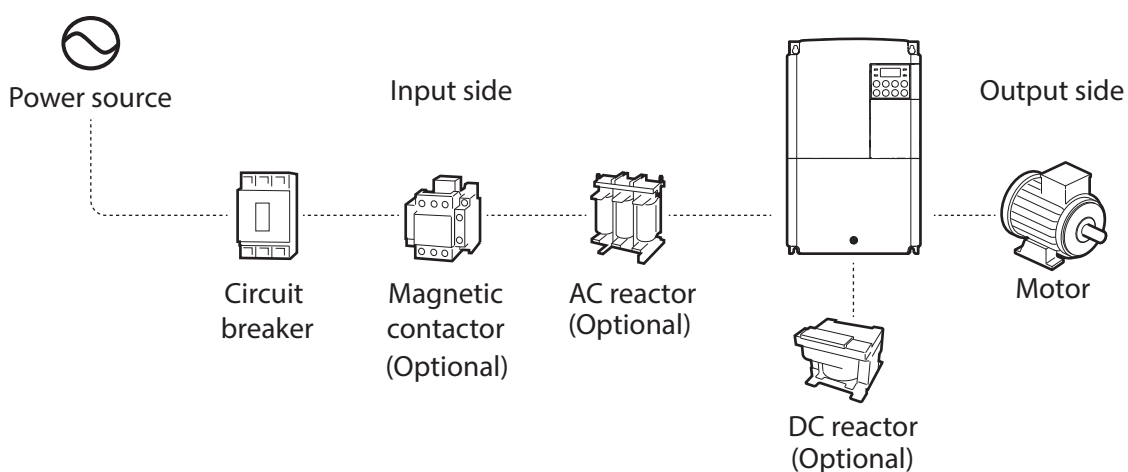

⚠ Caution

- Figures in this manual are shown with covers or circuit breakers removed to show a more detailed view of the installation arrangements. Install covers and circuit breakers before operating the inverter. Operate the product according to the instructions in this manual.
- Do not start or stop the inverter using a magnetic contactor, installed on the input power supply.
- If the inverter is damaged and loses control, the machine may cause a dangerous situation. Install an additional safety device such as an emergency brake to prevent these situations.
- High levels of current draw during power-on can affect the system. Ensure that correctly rated circuit breakers are installed to operate safely during power-on situations.
- Reactors can be installed to improve the power factor. Note that reactors may be installed within 30 ft (9.14 m) from the power source if the input power exceeds 10 times of inverter capacity. Refer to [11.5 Fuse and Reactor Specifications](#) on page [356](#) and carefully select a reactor that meets the requirements.

2.1 Mounting the Inverter

Mount the inverter on a wall or inside a panel following the procedures provided below. Before installation, ensure that there is sufficient space to meet the clearance specifications, and that there are no obstacles impeding the cooling fan's air flow.

Select a wall or panel suitable to support the installation. Refer to [11.3 External Dimensions \(IP 20 Type\)](#) on page [349](#) and check the inverter's mounting bracket dimensions.

- 1 Use a level to draw a horizontal line on the mounting surface, and then carefully mark the fixing points.
- 2 Drill the two upper mounting bolt holes, and then install the mounting bolts. Do not fully tighten the bolts at this time. Fully tighten the mounting bolts after the inverter has been mounted.

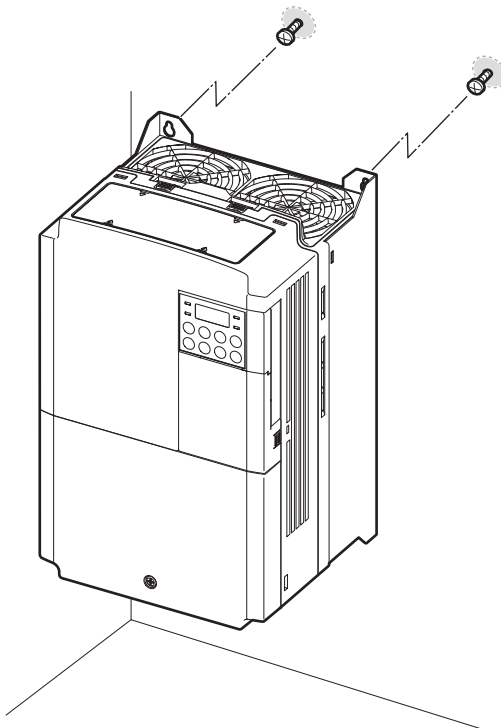

- 3 Mount the inverter on the wall or inside a panel using the two upper bolts, and then fully tighten the mounting bolts. Ensure that the inverter is placed flat on the mounting surface, and that the installation surface can securely support the weight of the inverter.

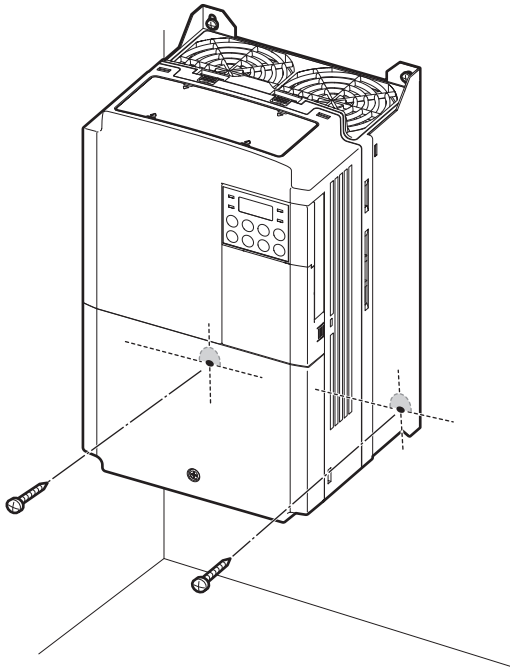

Note

The quantity and dimensions of the mounting brackets vary based on frame size. Refer to [11.3 External Dimensions \(IP 20 Type\)](#) on page 349 for detailed information about your model.

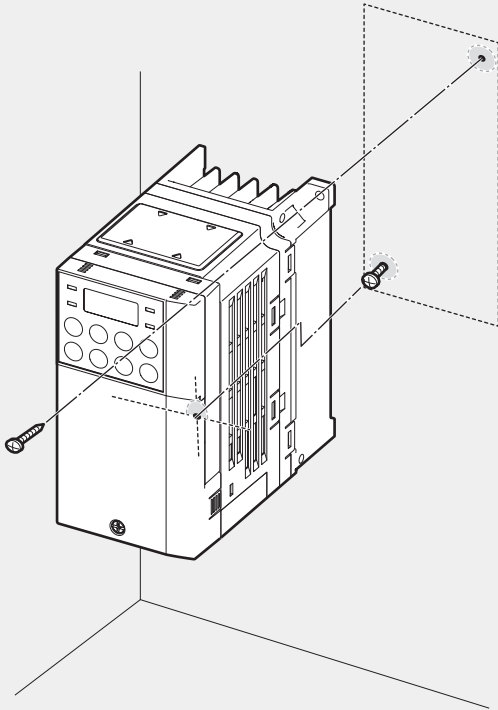

Inverters with small frames (0.4-0.8kW) have only two mounting brackets. Inverters with large frames have 4 mounting brackets.

⚠ Caution

- Do not transport the inverter by lifting with the inverter's covers or plastic surfaces. The inverter may tip over if covers break, causing injuries or damage to the product. Always support the inverter using the metal frames when moving it.
- Hi-capacity inverters are very heavy and bulky. Use an appropriate transport method that is suitable for the weight.
- Do not install the inverter on the floor or mount it sideways against a wall. The inverter **MUST** be installed vertically, on a wall or inside a panel, with its rear flat on the mounting surface.

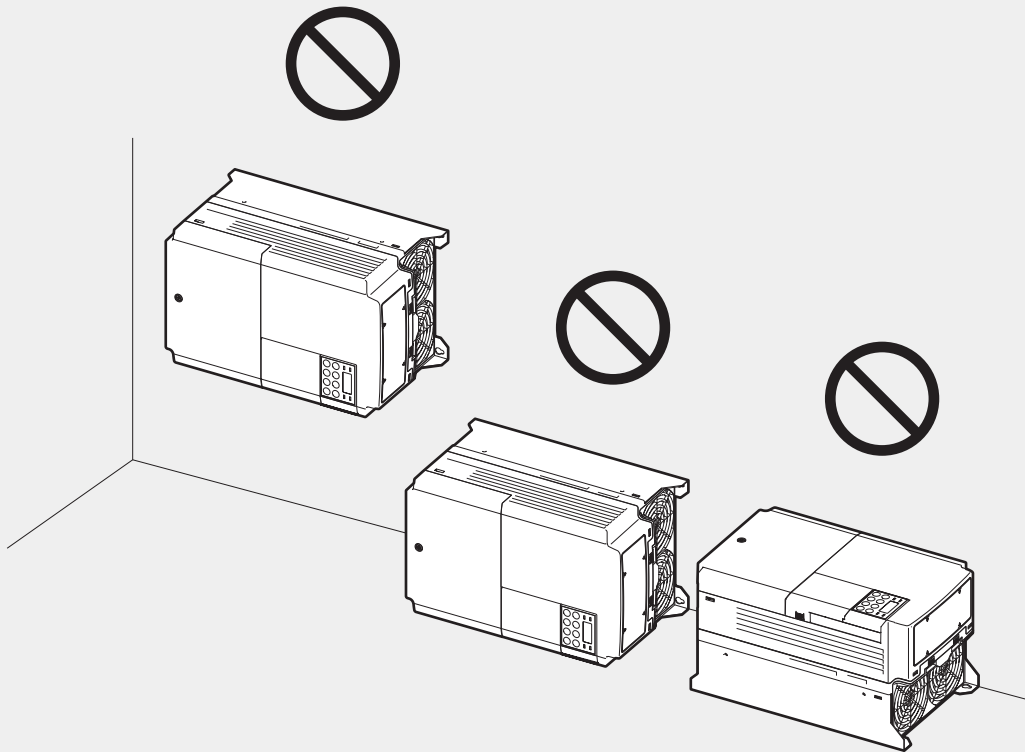

2.2 Cable Wiring

Open the front cover, remove the cable guides and control terminal cover, and then install the ground connection as specified. Complete the cable connections by connecting an appropriately rated cable to the terminals on the power and control terminal blocks.

Read the following information carefully before carrying out wiring connections to the inverter. All warning instructions must be followed.

⚠ Caution

- Install the inverter before carrying out wiring connections.
- Ensure that no small metal debris, such as wire cut-offs, remain inside the inverter. Metal debris in the inverter may cause inverter failure.
- Tighten terminal screws to their specified torque. Loose terminal block screws may allow the cables to disconnect and cause short circuit or inverter failure. Refer to [11.6 Terminal Screw Specification](#) on page 357 for torque specifications.
- Do not place heavy objects on top of electric cables. Heavy objects may damage the cable and result in electric shock.
- The power supply system for this equipment (inverter) is a grounded system. Only use a grounded power supply system for this equipment (inverter). Do not use a TT, TN, IT, or corner grounded system with the inverter.
- The equipment may generate direct current in the protective ground wire. When installing the residual current device (RCD) or residual current monitoring (RCM), only Type B RCDs and RCMs can be used.
- Use cables with the largest cross-sectional area, appropriate for power terminal wiring, to ensure that voltage drop does not exceed 2%.
- Use copper cables rated at 600V, 75 °C for power terminal wiring.
- Use copper cables rated at 300V, 75 °C for control terminal wiring.
- Separate control circuit wires from the main circuits and other high voltage circuits (200V relay sequence circuit).
- Check for short circuits or wiring failure in the control circuit. They could cause system failure or device malfunction.
- Use shielded cables when wiring the control circuit. Failure to do so may cause malfunction due to interference. If a ground is needed, use STP (Shielded Twisted Pair) cables.
- If you need to re-wire the terminals due to wiring-related faults, ensure that the inverter keypad display is turned off and the charge lamp under the front cover is off before working on wiring connections. The inverter may hold a high voltage electric charge long after the power supply has been turned off.

Step 1 Front Cover, Control Terminal Cover and Cable Guide

The front cover, control terminal cover and cable guide must be removed to install cables. Refer to the following procedures to remove the covers and cable guide. The steps to remove these parts may vary depending on the inverter model.

0.8-1.5kW (single phase), 1.5-2.2kW (3-phase)

- 1 Loosen the bolt that secures the front cover (right side). Push and hold the latch on the right side of the cover. Then remove the cover by lifting it from the bottom and moving it away from the front of the inverter.

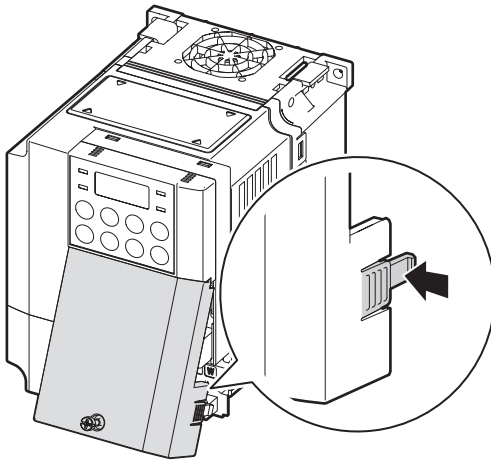

- 2 Remove the bolt that secures the front cover (left side) (❶). Push and hold the latch on the left side of the cover. Then remove the cover by lifting it from the bottom and moving it away from the front of the inverter (❷).

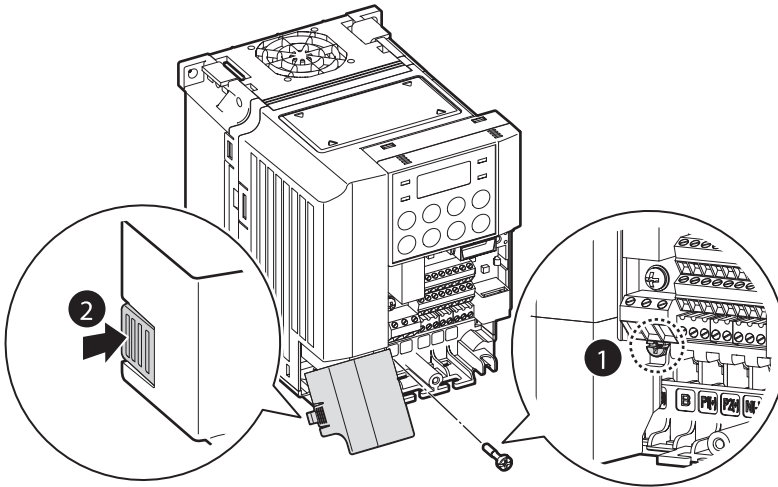

- 3 Connect the cables to the power terminals and the control terminals. For cable specifications, refer to [1.5 Cable Selection](#) on page [10](#).

5.5-22kW (3-phase)

- 1 Loosen the bolt that secures the front cover. Then remove the cover by lifting it from the bottom and away from the front.

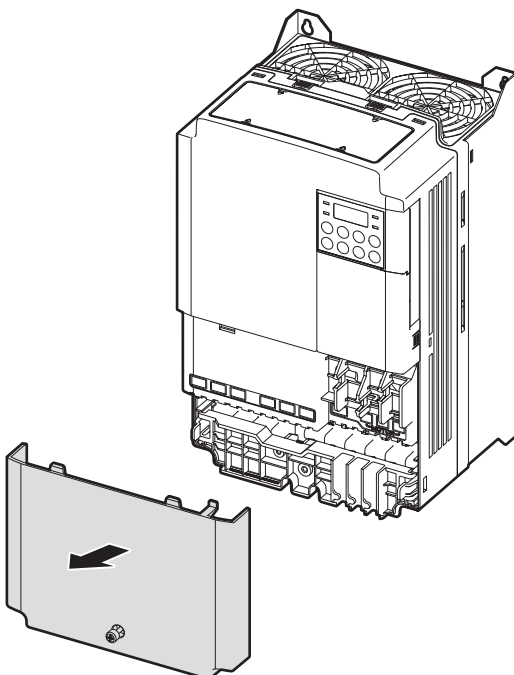

- 2 Push and hold the levers on both sides of the cable guide (❶) and then remove the cable guide by pulling it directly away from the front of the inverter (❷). In some models where the cable guide is secured by a bolt, remove the bolt first.

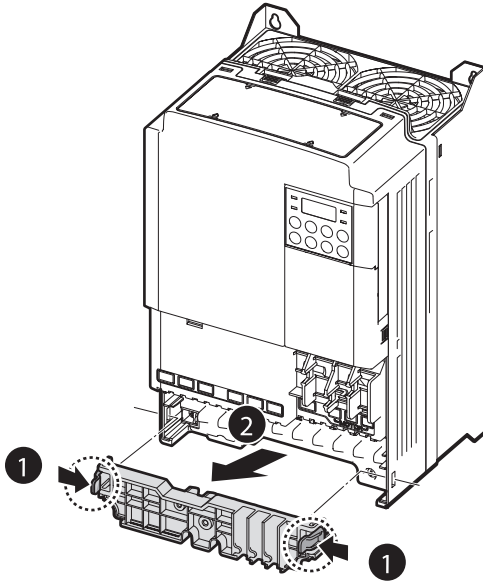

- 3 Push and hold the tab on the right side of the control terminal cover. Then remove the cover by lifting it from the bottom and moving it away from the front of the inverter.

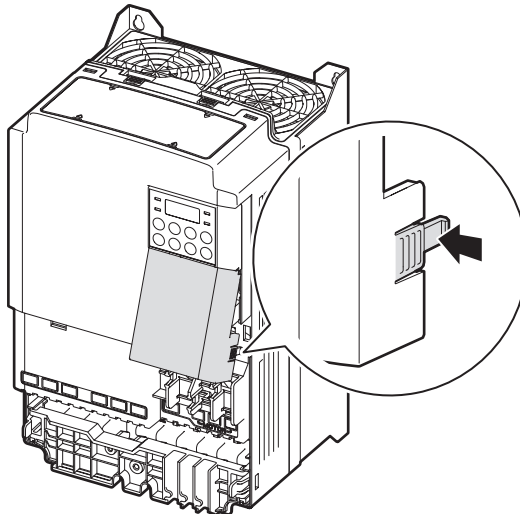

- 4 Connect the cables to the power terminals and the control terminals. For cable specifications, refer to [1.5 Cable Selection](#) on page [10](#).

Note

To connect an LCD keypad, remove the plastic knock-out from the bottom of the front cover (right side) or from the control terminal cover. Then connect the signal cable to the RJ-45 port on the control board.

Step 2 Ground Connection

Remove the front cover(s), cable guide, and the control terminal cover. Then follow the instructions below to install the ground connection for the inverter.

- 1 Locate the ground terminal and connect an appropriately rated ground cable to the terminals. Refer to [1.5 Cable Selection](#) on page [10](#) to find the appropriate cable specification for your installation.

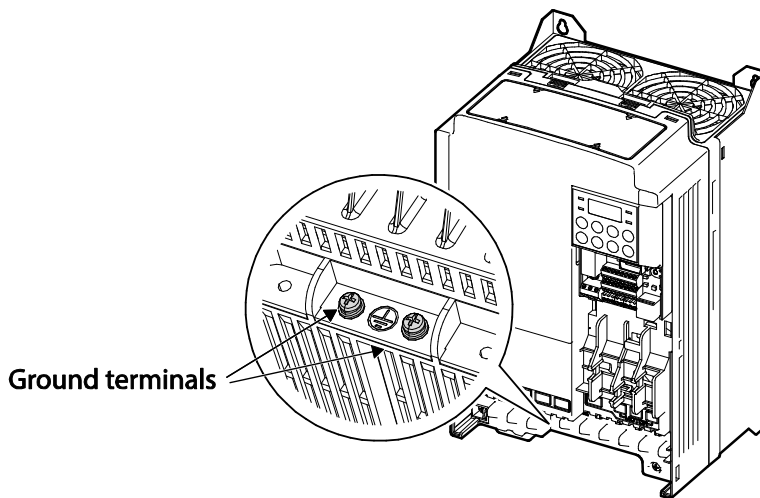

- 2 Connect the other ends of the ground cables to the supply earth (ground) terminal.

Note

- 200 V products require Class 3 grounding. Resistance to ground must be $< 100\Omega$.
- 400 V products require Special Class 3 grounding. Resistance to ground must be $< 10\Omega$.

Warning

Install ground connections for the inverter and the motor by following the correct specifications to ensure safe and accurate operation. Using the inverter and the motor without the specified grounding connections may result in electric shock.

Step 3 Power Terminal Wiring

The following illustration shows the terminal layout on the power terminal block. Refer to the detailed descriptions to understand the function and location of each terminal before making wiring connections. Ensure that the cables selected meet or exceed the specifications in [1.5 Cable Selection](#) on page [10](#) before installing them.

Caution

- Apply rated torques to the terminal screws. Loose screws may cause short circuits and malfunctions. Tightening the screw too much may damage the terminals and cause short circuits and malfunctions.
- Use copper wires only with 600V, 75°C rating for the power terminal wiring, and 300V, 75°C rating for the control terminal wiring.
- Do not connect two wires to one terminal when wiring the power.
- Power supply wirings must be connected to the R, S, and T terminals. Connecting them to the U, V, W terminals causes internal damages to the inverter. Motor should be connected to the U, V, and W terminals. Arrangement of the phase sequence is not necessary.

Attention

- Appliquer des couples de marche aux vis des bornes. Des vis desserrées peuvent provoquer des courts-circuits et des dysfonctionnements. Ne pas trop serrer la vis, car cela risqué d'endommager les bornes et de provoquer des courts-circuits et des dysfonctionnements. Utiliser uniquement des fils de cuivre avec une valeur nominale de 600 V, 75 °C pour le câblage de la borne d'alimentation, et une valeur nominale de 300 V, 75 °C pour le câblage de la borne de commande.
- Ne jamais connecter deux câbles à une borne lors du câblage de l'alimentation.
- Les câblages de l'alimentation électrique doivent être connectés aux bornes R, S et T. Leur connexion aux bornes U, V et W provoque des dommages internes à l'onduleur. Le moteur doit être raccordé aux bornes U, V et W. L'arrangement de l'ordre de phase n'est pas nécessaire.

0.4kW (single phase), 0.4~0.8kW (3-phase)

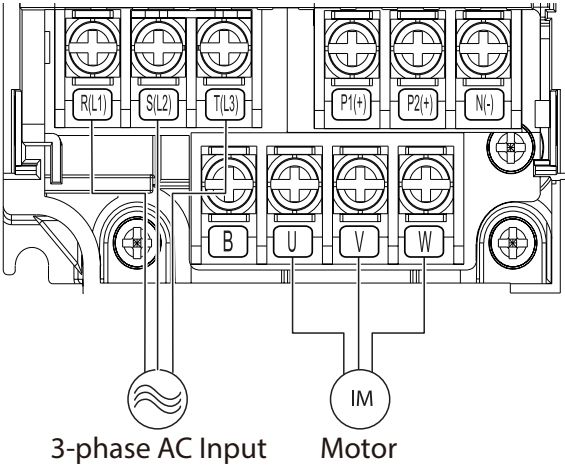

0.8-1.5kW (single phase), 1.5-2.2kW (3-phase)

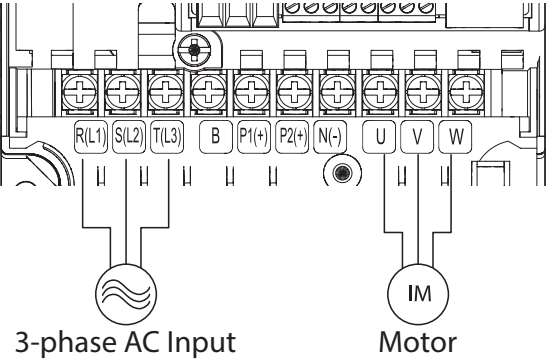

2.2kW (single phase), 3.7~4.0kW (3-phase)

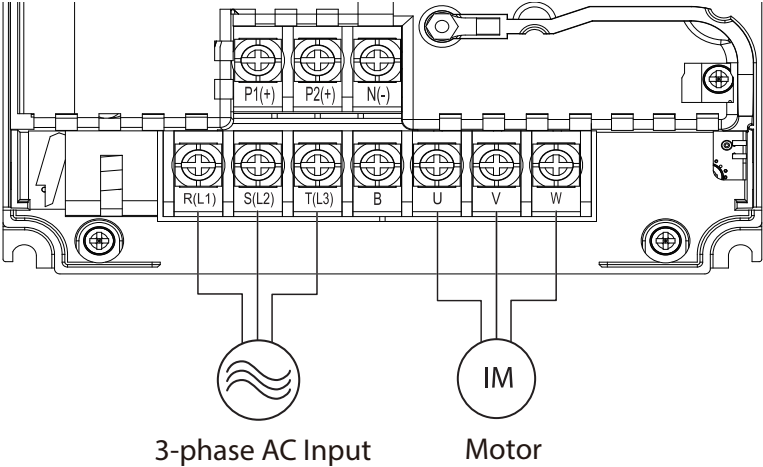

5.5-22kW (3-phase)

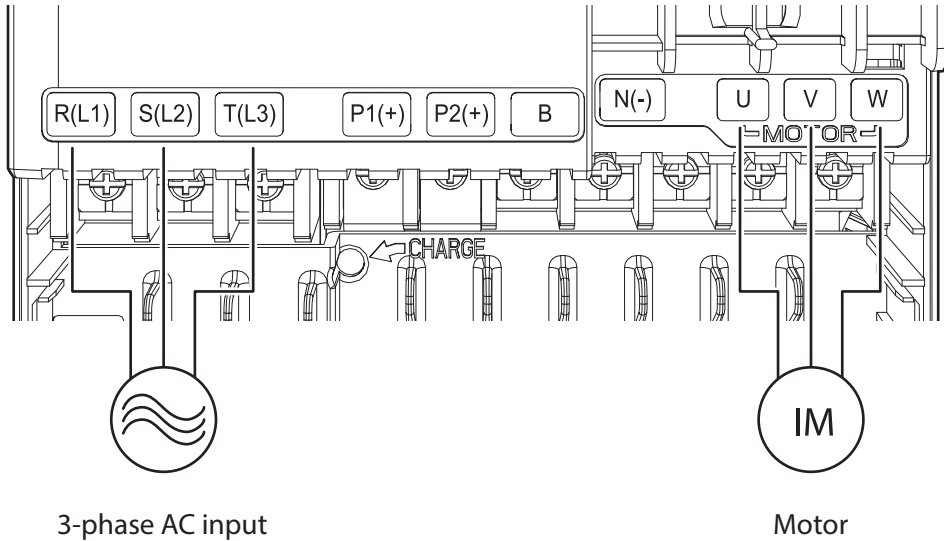

Power Terminal Labels and Descriptions

| Terminal Labels | Name | Description |
|-------------------|--------------------------|--|
| R(L1)/S(L2)/T(L3) | AC power input terminal | Mains supply AC power connections. |
| P2(+)/N(-) | DC link terminal | DC voltage terminals. |
| P1(+)/P2(+) | DC reactor terminal | DC reactor wiring connection. (When you use the DC reactor, must remove short-bar) |
| P2(+)/B | Brake resistor terminals | Brake resistor wiring connection. |
| U/V/W | Motor output terminals | 3-phase induction motor wiring connections. |

Note

- Use STP (Shielded Twisted Pair) cables to connect a remotely located motor with the inverter. Do not use 3 core cables.
- When you operating Brake resistor, the motor may vibrate under the Flux braking operation. In this case, please turn off the Flux braking(Pr.50).
- Make sure that the total cable length does not exceed 665ft (202m). For inverters $\leq 4.0\text{kW}$ capacity, ensure that the total cable length does not exceed 165ft (50m).
- Long cable runs can cause reduced motor torque in low frequency applications due to voltage drop. Long cable runs also increase a circuit's susceptibility to stray capacitance and may trigger over-current protection devices or result in malfunction of equipment connected to the inverter.
- Voltage drop is calculated by using the following formula:

$$\text{Voltage Drop (V)} = [\sqrt{3} \times \text{cable resistance (m}\Omega\text{/m)} \times \text{cable length (m)} \times \text{current(A)}] / 1000$$

- Use cables with the largest possible cross-sectional area to ensure that voltage drop is minimized over long cable runs. Lowering the carrier frequency and installing a micro surge filter may also help to reduce voltage drop.

| Distance | < 165ft (50m) | < 330ft (100m) | > 330ft (100m) |
|---------------------------|---------------|----------------|----------------|
| Allowed Carrier Frequency | < 15 kHz | < 5 kHz | < 2.5 kHz |

Warning

Do not connect power to the inverter until installation has been fully completed and the inverter is ready to be operated. Doing so may result in electric shock.

Caution

- Power supply cables must be connected to the R, S, and T terminals. Connecting power cables to other terminals will damage the inverter.
- Use insulated ring lugs when connecting cables to R/S/T and U/V/W terminals.
- The inverter's power terminal connections can cause harmonics that may interfere with other communication devices located near to the inverter. To reduce interference the installation of noise filters or line filters may be required.
- To avoid circuit interruption or damaging connected equipment, do not install phase-advanced condensers, surge protection, or electronic noise filters on the output side of the inverter.
- To avoid circuit interruption or damaging connected equipment, do not install magnetic contactors on the output side of the inverter.

Step 4 Control Terminal Wiring

The illustrations below show the detailed layout of control wiring terminals, and control board switches. Refer to the detailed information provided below and [1.5 Cable Selection](#) on page [10](#) before installing control terminal wiring and ensure that the cables used meet the required specifications.

Installing the Inverter

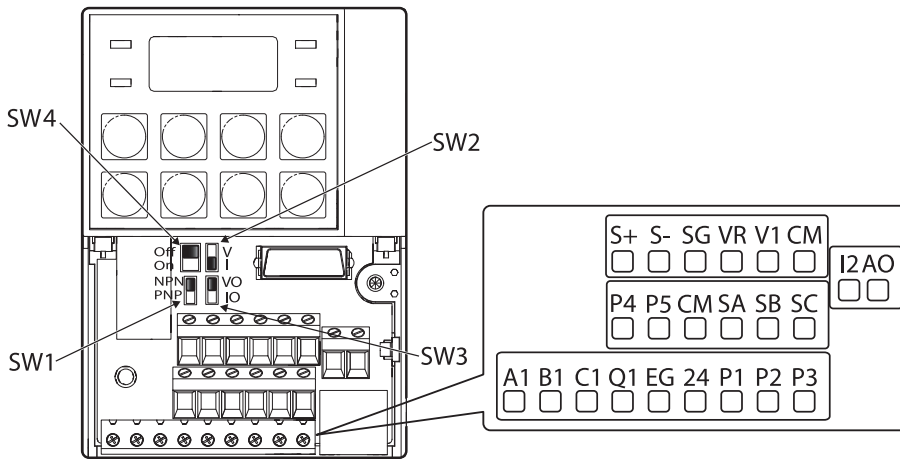

<Standard I/O>

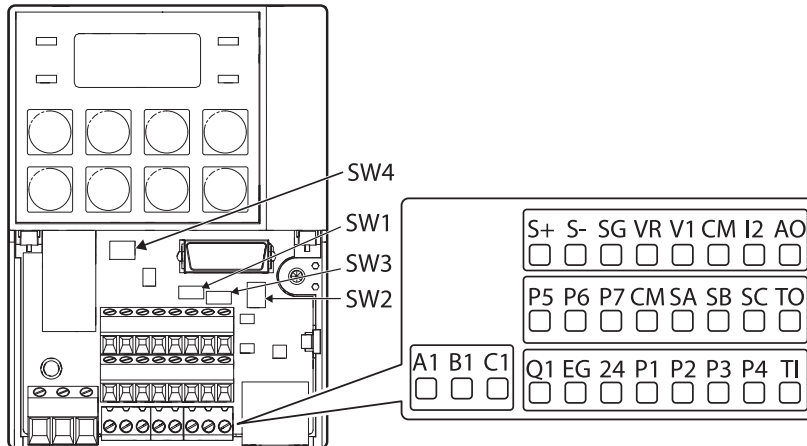

<Multiple I/O>

Control Board Switches

| Switch | Description |
|--------|---|
| SW1 | NPN/PNP mode selection switch |
| SW2 | analog voltage/current input terminal selection switch |
| SW3 | analog voltage/current output terminal selection switch |
| SW4 | Terminating Resistor selection switch |

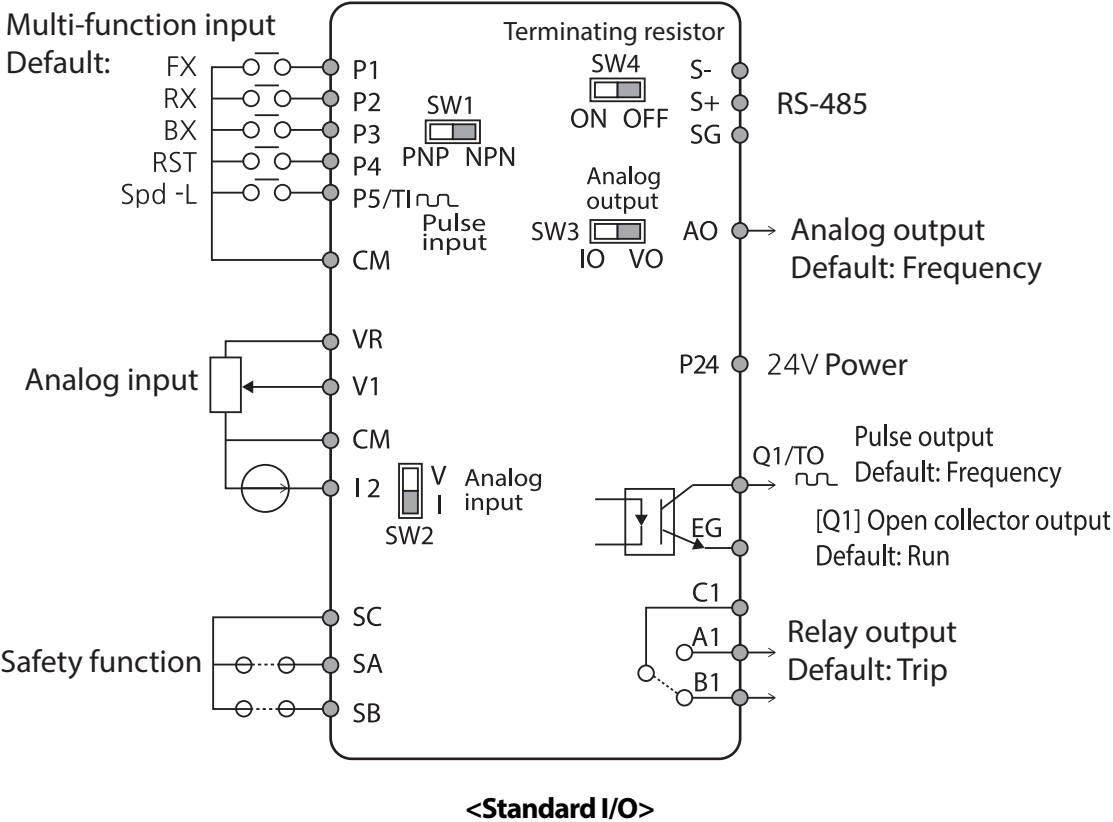

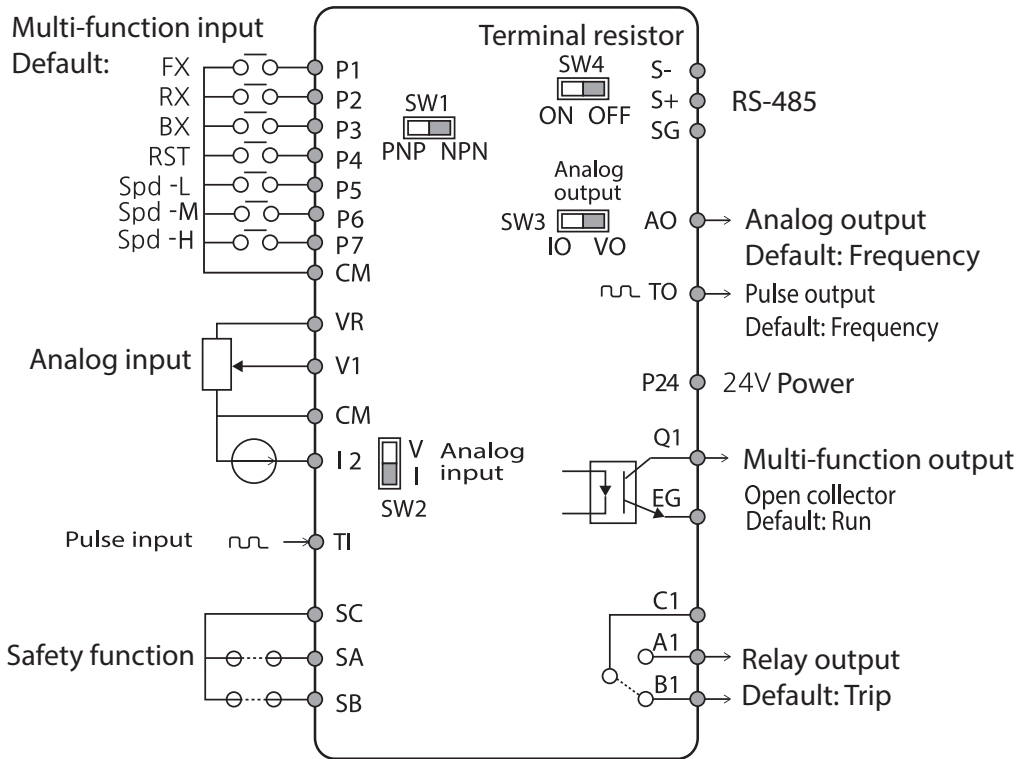

<Multiple I/O>

Input Terminal Labels and Descriptions

| Function | Label | Name | Description |
|---------------------------------------|-------|---|---|
| Multi-function terminal configuration | P1-P7 | Multi-function Input 1-7 | Configurable for multi-function input terminals. Factory default terminals and setup are as follows: <ul style="list-style-type: none"> • P1: Fx • P2: Rx • P3: BX • P4: RST • P5: Speed-L • P6: Speed-M • P7: Speed-H Standard I/O is only provided for P5. |
| | CM | Common Sequence | Common terminal for analog terminal inputs and outputs. |
| Analog input configuration | VR | Potentiometer frequency reference input | Used to setup or modify a frequency reference via analog voltage or current input. <ul style="list-style-type: none"> • Maximum Voltage Output: 12V • Maximum Current Output: 100mA, |

| Function | Label | Name | Description |
|------------------------------------|-------|---|--|
| | | | <ul style="list-style-type: none"> Potentiometer: 1–5kΩ |
| | V1 | Voltage input for frequency reference input | Used to setup or modify a frequency reference via analog voltage input terminal. <ul style="list-style-type: none"> Unipolar: 0–10V (12V Max.) Bipolar: -10–10V (±12V Max.) |
| | I2 | Voltage/current input for frequency reference input | Used to setup or modify a frequency reference via analog voltage or current input terminals. Switch between voltage (V2) and current (I2) modes using a control board switch (SW2). <p>V2 Mode:</p> <ul style="list-style-type: none"> Unipolar: 0–10V (12V Max.) <p>I2 Mode</p> <ul style="list-style-type: none"> Input current: 4–20mA Maximum Input current: 24mA Input resistance: 249Ω |
| | TI | Pulse input for frequency reference input (pulse train) | Setup or modify frequency references using pulse inputs from 0 to 32kHz. <ul style="list-style-type: none"> Low Level: 0–0.8V High Level: 3.5–12V (In case of Standard I/O, Pulse input TI and Multi-function terminal P5 share the same terminal. Set the In.69 P5 Define to 54(TI)). |
| Safety functionality configuration | SA | Safety input A | Used to block the output from the inverter in an emergency. |
| | SB | Safety input B | Conditions: <ul style="list-style-type: none"> Normal Operation: Both the SA and SB terminals are connected to the SC terminal. Output Block: One or both of the SA and SB terminals lose connection with the SC terminal. |
| | SC | Safety input power source | DC 24V, < 25mA |

Output/Communication Terminal Labels and Descriptions

| Function | Label | Name | Description |
|---------------|-------|------------------------|---|
| Analog output | AO | Voltage/Current Output | Used to send inverter output information to external devices: output frequency, output current, output voltage, or a DC voltage. Operate switch (SW3) to select the signal output type (voltage or current) at the AO terminal. Output Signal Specifications: |

| Function | Label | Name | Description |
|----------------|--------------|-----------------------------------|---|
| | | | <ul style="list-style-type: none"> Output voltage: 0–10V Maximum output voltage/current: 12V/10mA Output current: 0–20mA Maximum output current: 24mA Factory default output: Frequency |
| | TO | Pulse Output | <p>Sends pulse signals to external devices to provide a single output value from the inverter of either: output frequency, output current, output voltage, or DC voltage.</p> <p>Output Signal Specifications:</p> <ul style="list-style-type: none"> Output frequency: 0–32kHz Output voltage: 0–12V Factory default output: Frequency <p>(In case of Standard I/O, Pulse output TO and Multi-function output Q1 share the same terminal. Set the OU.33Q1 Define to 38(TO).)</p> <p>When connecting to a pulse between the S100 inverters, please connect pulse output(Q1-EG) to pulse input(TI-CM) directly without resistor and wire.</p> |
| Digital output | Q1 | Multi-functional (open collector) | DC 26V, 100mA or less Factory default output: Run |
| | EG | Common | Common ground contact for an open collector (with external power source) |
| | 24 | External 24V power source | Maximum output current: 150mA |
| | A1/C1/B1 | Fault signal output | <p>Sends out alarm signals when the inverter's safety features are activated (AC 250V < 1A, DC 30V < 1A).</p> <ul style="list-style-type: none"> Fault condition: A1 and C1 contacts are connected (B1 and C1 open connection) Normal operation: B1 and C1 contacts are connected (A1 and C1 open connection) |
| Communication | S+ / S- / SG | RS-485 signal line | Used to send or receive RS-485 signals. Refer to 7. RS-485 Communication Features on page 219 for more details. |

Preinsulated Crimp Terminal Connectors (Bootlace Ferrule) .

Use preinsulated crimp terminal connectors to increase reliability of the control terminal wiring. Refer to the specifications below to determine the crimp terminals to fit various cable sizes.

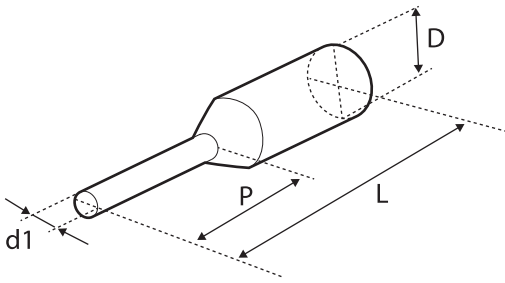

| P/N | Cable Spec. | | Dimensions (inches/mm) | | | | Manufacturer |
|----------|-------------|-----------------|------------------------|------------|------------|-------------|--|
| | AWG | mm ² | L* | P | d1 | D | |
| CE002506 | 26 | 0.25 | 10.4 | 0.4 / 6.0 | 0.04 / 1.1 | 0.1 / 2.5 | JEONO (Jeono Electric, http://www.jeono.com/) |
| CE002508 | | | 12.4 | 0.5 / 8.0 | | | |
| CE005006 | 22 | 0.50 | 12.0 | 0.45 / 6.0 | 0.05 / 1.3 | 0.125 / 3.2 | |
| CE007506 | 20 | 0.75 | 12.0 | 0.45 / 6.0 | 0.06 / 1.5 | 0.13 / 3.4 | |

* If the length (L) of the crimp terminals exceeds 0.5" (12.7mm) after wiring, the control terminal cover may not close fully.

To connect cables to the control terminals without using crimp terminals, refer to the following illustration detailing the correct length of exposed conductor at the end of the control cable.

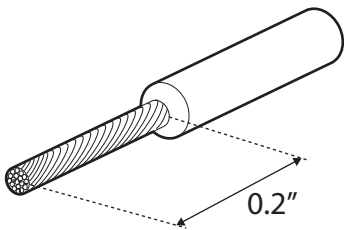

Note

- While making wiring connections at the control terminals, ensure that the total cable length does not exceed 165ft (50m).
- Ensure that the length of any safety related wiring does not exceed 100ft (30m).
- Ensure that the cable length between an LCD keypad and the inverter does not exceed 10ft (3.04m). Cable connections longer than 10ft (3.04m) may cause signal errors.
- Use ferrite material to protect signal cables from electro-magnetic interference.
- Take care when supporting cables using cable ties, to apply the cable ties no closer than 6 inches from the inverter. This provides sufficient access to fully close the front cover.
- When making control terminal cable connections, use a small flat-tip screw driver (0.1in wide (2.5mm) and 0.015in thick (0.4mm) at the tip).

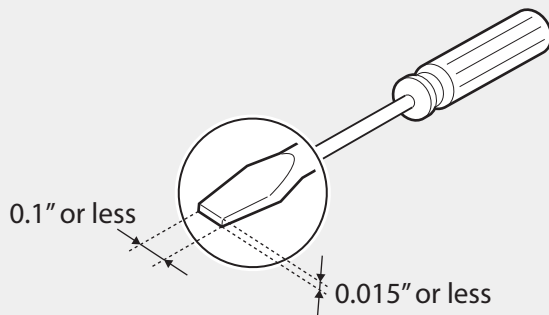

⚠ Warning

SA,SB, SC, they are shorted, have 24V voltage. Do not connect power to the inverter until installation has been fully completed and the inverter is ready to be operated. Doing so may result in electric shock.

Step 5 PNP/NPN Mode Selection

The S100 inverter supports both PNP (Source) and NPN (Sink) modes for sequence inputs at the terminal. Select an appropriate mode to suit requirements using the PNP/NPN selection switch (SW1) on the control board. Refer to the following information for detailed applications.

PNP Mode (Source)

Select PNP using the PNP/NPN selection switch (SW1). Note that the factory default setting is NPN mode. CM is the common ground terminal for all analog inputs at the terminal, and P24 is 24V internal source. If you are using an external 24V source, build a circuit that connects the external source (-) and the CM terminal.

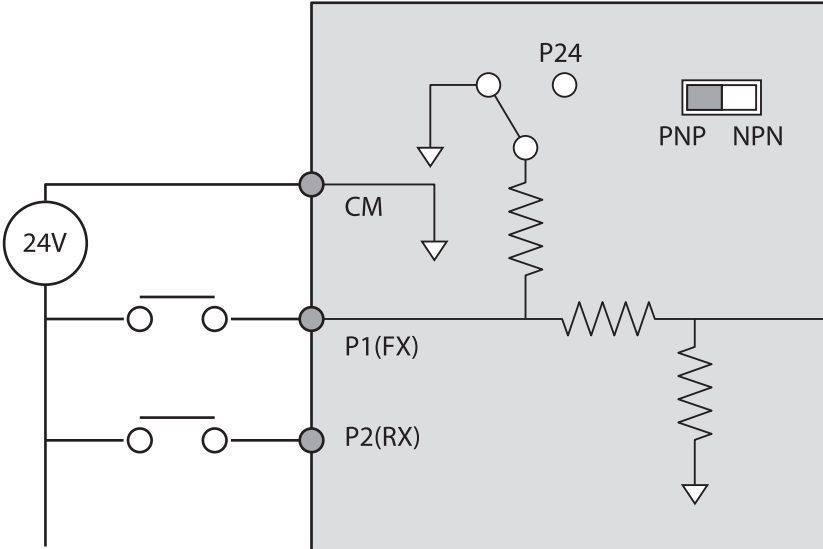

NPN Mode (Sink)

Select NPN using the PNP/NPN selection switch (SW1). Note that the factory default setting is NPN mode. CM is the common ground terminal for all analog inputs at the terminal, and P24 is 24V internal source.

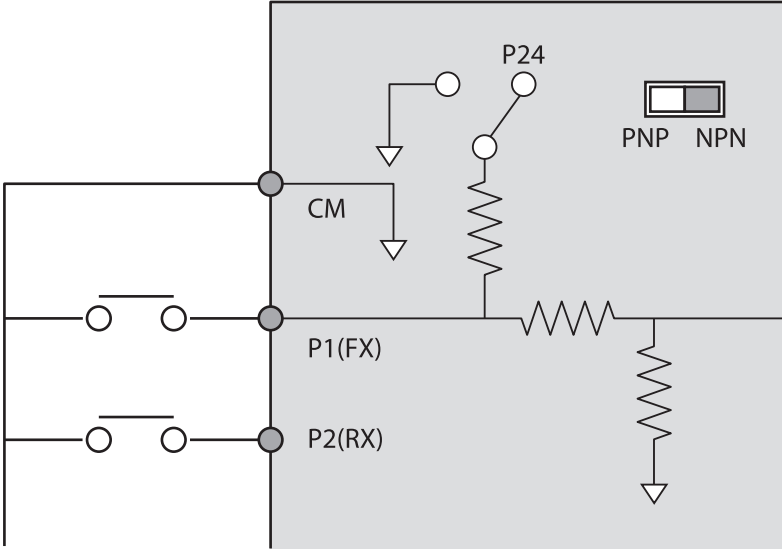

Step 6 Disabling the EMC Filter for Power Sources with Asymmetrical Grounding

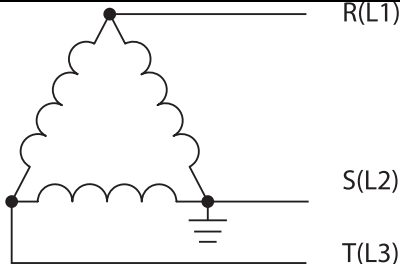
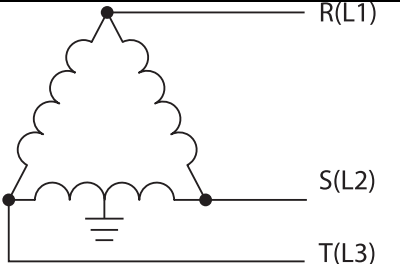
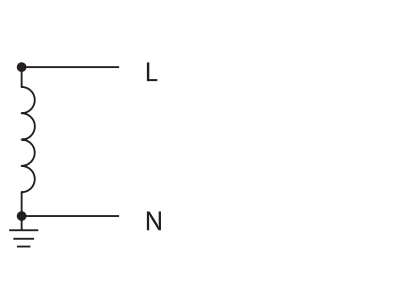
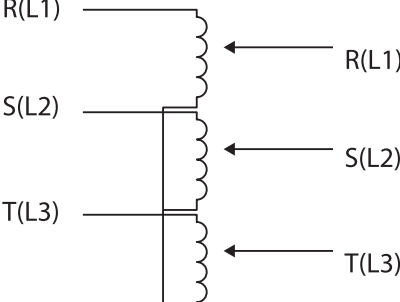

EMC filter is built in the next two products. S100 200V single-phase built-in EMC filter and the 400V class. An EMC filter prevents electromagnetic interference by reducing radio emissions from the inverter. EMC filter use is not always recommended, as it increases leakage current. If an inverter uses a power source with an asymmetrical grounding connection, the EMC filter **MUST** be turned off.

| Asymmetrical Grounding Connection | | | |
|---|--|---|---|
| One phase of a delta connection is grounded |  | Intermediate grounding point on one phase of a delta connection |  |
| The end of a single phase is grounded |  | A 3-phase connection without grounding |  |

⚠ Danger

- Do not activate the EMC filter if the inverter uses a power source with an asymmetrical grounding structure, for example a grounded delta connection. Personal injury or death by electric shock may result.
- Wait at least 10 minutes before opening the covers and exposing the terminal connections. Before starting work on the inverter, test the connections to ensure all DC voltage has been fully discharged. Personal injury or death by electric shock may result.

Before using the inverter, confirm the power supply's grounding system. Disable the EMC filter if the power source has an asymmetrical grounding connection. Refer to the figures below to locate the EMC filter on/off terminal and replace the metal bolt with the plastic bolt. If the EMC filter is required in the future, reverse the steps and replace the plastic bolt with the metal bolt to reconnect the EMC filter.

| Steel bolt | Plastic bolt |
|---|---|
|  |  |
| EMC ON | EMC OFF |

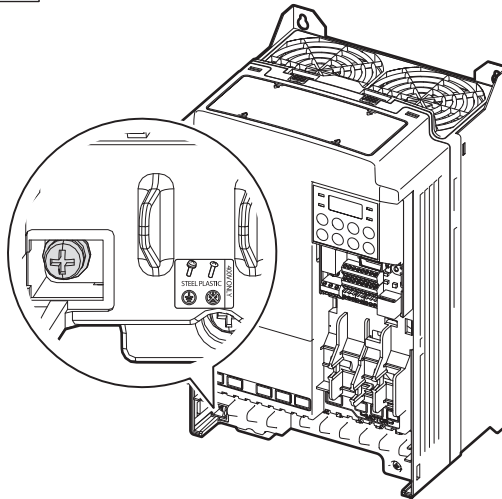

Step 7 Re-assembling the Covers and Routing Bracket

Re-assemble the cable routing bracket and the covers after completing the wiring and basic configurations. Note that the assembly procedure may vary according to the product group or frame size of the product.

2.3 Post-Installation Checklist

After completing the installation, check the items in the following table to make sure that the inverter has been safely and correctly installed.

| Items | Check Point | Ref. | Result |
|--|--|--------------|--------|
| Installation Location/Power I/O Verification | Is the installation location appropriate? | <u>p.5</u> | |
| | Does the environment meet the inverter's operating conditions? | <u>p.6</u> | |
| | Does the power source match the inverter's rated input? | <u>p.341</u> | |
| | Is the inverter's rated output sufficient to supply the equipment? (Degraded performance will result in certain circumstances. Refer to <i>11.8 Continuous Rated Current Derating</i> on page 360 for details.) | <u>p.341</u> | |
| Power Terminal Wiring | Is a circuit breaker installed on the input side of the inverter? | <u>p.14</u> | |
| | Is the circuit breaker correctly rated? | <u>p.341</u> | |
| | Are the power source cables correctly connected to the R/S/T terminals of the inverter? (Caution: connecting the power source to the U/V/W terminals may damage the inverter.) | <u>p.24</u> | |
| | Are the motor output cables connected in the correct phase rotation (U/V/W)? (Caution: motors will rotate in reverse direction if three phase cables are not wired in the correct rotation.) | <u>p.24</u> | |
| | Are the cables used in the power terminal connections correctly rated? | <u>p.10</u> | |
| | Is the inverter grounded correctly? | <u>p.23</u> | |
| | Are the power terminal screws and the ground terminal screws tightened to their specified torques? | <u>p.24</u> | |
| | Are the overload protection circuits installed correctly on the motors (if multiple motors are run using one inverter)? | - | |
| | Is the inverter separated from the power source by a magnetic contactor (if a braking resistor is in use)? | <u>p.14</u> | |
| | Are advanced-phase capacitors, surge protection and electromagnetic interference filters installed correctly? (These devices MUST not be installed on the output side of the inverter.) | <u>p.24</u> | |
| Control Terminal Wiring | Are STP (shielded twisted pair) cables used for control terminal wiring? | - | |
| | Is the shielding of the STP wiring properly grounded? | - | |
| | If 3-wire operation is required, are the multi-function input terminals defined prior to the installation of the control wiring connections? | <u>p.27</u> | |

| Items | Check Point | Ref. | Result |
|---------------|--|--------------|--------|
| | Are the control cables properly wired? | <u>p.27</u> | |
| | Are the control terminal screws tightened to their specified torques? | <u>p.19</u> | |
| | Is the total cable length of all control wiring < 165ft (100m)? | <u>p.33</u> | |
| | Is the total length of safety wiring < 100ft (30m)? | <u>p.33</u> | |
| Miscellaneous | Are optional cards connected correctly? | - | |
| | Is there any debris left inside the inverter? | <u>p.19</u> | |
| | Are any cables contacting adjacent terminals, creating a potential short circuit risk? | - | |
| | Are the control terminal connections separated from the power terminal connections? | - | |
| | Have the capacitors been replaced if they have been in use for > 2 years? | - | |
| | Have the fans been replaced if they have been in use for > 3 years? | - | |
| | Has a fuse been installed for the power source? | <u>p.356</u> | |
| | Are the connections to the motor separated from other connections? | - | |

Note

STP (Shielded Twisted Pair) cable has a highly conductive, shielded screen around twisted cable pairs. STP cables protect conductors from electromagnetic interference.

2.4 Test Run

After the post-installation checklist has been completed, follow the instructions below to test the inverter.

- 1 Turn on the power supply to the inverter. Ensure that the keypad display light is on.
- 2 Select the command source.
- 3 Set a frequency reference, and then check the following:
 - If V1 is selected as the frequency reference source, does the reference change according to the input voltage at VR?
 - If V2 is selected as the frequency reference source, is the voltage/current selector switch (SW2) set to voltage, and does the reference change according to the input voltage?

- If I2 is selected as the frequency reference source, is the voltage/current selector switch (SW2) set to current, and does the reference change according to the input current?
- 4 Set the acceleration and deceleration time.
 - 5 Start the motor and check the following:
 - Ensure that the motor rotates in the correct direction (refer to the note below).
 - Ensure that the motor accelerates and decelerates according to the set times, and that the motor speed reaches the frequency reference.

Note

If the forward command (Fx) is on, the motor should rotate counterclockwise when viewed from the load side of the motor. If the motor rotates in the reverse direction, switch the cables at the U and V terminals.

Remarque

Si la commande avant (Fx) est activée, le moteur doit tourner dans le sens anti-horaire si on le regarde côté charge du moteur. Si le moteur tourne dans le sens inverse, inverser les câbles aux bornes U et V.

Verifying the Motor Rotation

- 1 On the keypad, set the drv (Frequency reference source) code in the Operation group to 0 (Keypad).
- 2 Set a frequency reference.
- 3 Press the [RUN] key. Motor starts forward operation.
- 4 Observe the motor's rotation from the load side and ensure that the motor rotates counterclockwise (forward).

If the motor rotates in the reverse direction, two of the U/V/W terminals need to be switched.

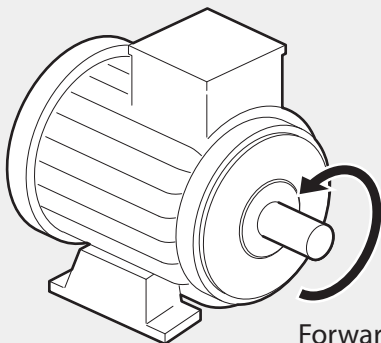

Forward operation

⚠ Caution

- Check the parameter settings before running the inverter. Parameter settings may have to be adjusted depending on the load.
- To avoid damaging the inverter, do not supply the inverter with an input voltage that exceeds the rated voltage for the equipment.
- Before running the motor at maximum speed, confirm the motor's rated capacity. As inverters can be used to easily increase motor speed, use caution to ensure that motor speeds do not accidentally exceed the motor's rated capacity.

3 Learning to Perform Basic Operations

This chapter describes the keypad layout and functions. It also introduces parameter groups and codes, required to perform basic operations. The chapter also outlines the correct operation of the inverter before advancing to more complex applications. Examples are provided to demonstrate how the inverter actually operates.

3.1 About the Keypad

The keypad is composed of two main components – the display and the operation (input) keys. Refer to the following illustration to identify part names and functions.

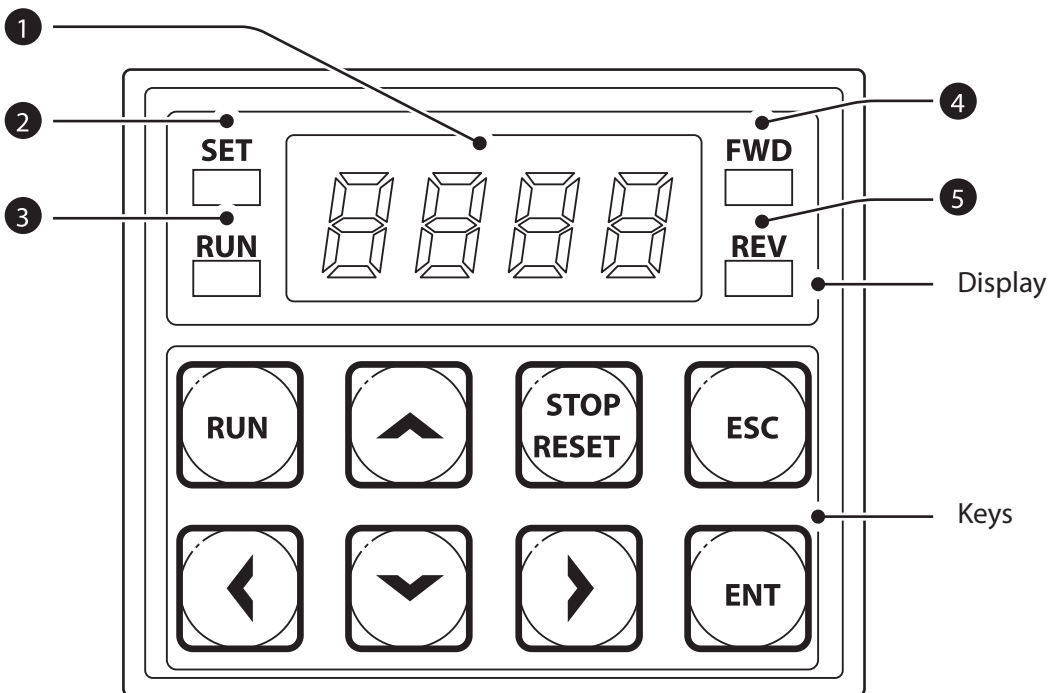

3.1.1 About the Display

The following table lists display part names and their functions.







| No. | Name | Function |
|-----|-------------------|---|
| ① | 7-Segment Display | Displays current operational status and parameter information. |
| ② | SET Indicator | LED flashes during parameter configuration and when the ESC key operates as the multi-function key. |
| ③ | RUN Indicator | LED turns on (steady) during an operation, and flashes during acceleration or deceleration. |
| ④ | FWD Indicator | LED turns on (steady) during forward operation. |
| ⑤ | REV Indicator | LED turns on (steady) during reverse operation. |

The table below lists the way that the keypad displays characters (letters and numbers).

| | | | | | | | |
|---|---|---|---|---|---|---|---|
| 0 | 0 | A | A | K | K | U | U |
| 1 | 1 | b | B | L | L | v | V |
| 2 | 2 | C | C | m | M | W | W |
| 3 | 3 | d | D | n | N | X | X |
| 4 | 4 | E | E | O | O | Y | Y |
| 5 | 5 | F | F | P | P | Z | Z |
| 6 | 6 | G | G | Q | Q | - | - |
| 7 | 7 | H | H | R | R | - | - |
| 8 | 8 | I | I | S | S | - | - |
| 9 | 9 | J | J | T | T | - | - |

3.1.2 Operation Keys

The following table lists the names and functions of the keypad's operation keys.

| Key | Name | Description |
|---|------------------|--|
|  | [RUN] key | Used to run the inverter (inputs a RUN command). |
|  | [STOP/RESET] key | STOP: stops the inverter. RESET: resets the inverter following fault or failure condition. |
|  | [▲] key, [▼] key | Switch between codes, or to increase or decrease parameter values. |
|  | [◀] key, [▶] key | Switch between groups, or to move the cursor during parameter setup or modification. |
|  | [ENT] key | Used to select, confirm, or save a parameter value. |
|  | [ESC] key | A multi-function key used to configure different functions, such as: <ul style="list-style-type: none"> • Jog operation • Remote/Local mode switching • Cancellation of an input during parameter setup |

⚠ Caution

Install a separate emergency stop switch in the circuit. The [STOP/RESET] key on the keypad works only when the inverter has been configured to accept an input from the keypad.

3.1.3 Control Menu

The S100 inverter control menu uses the following groups.

| Group | Display | Description |
|---------------------------|---------|---|
| Operation | - | Configures basic parameters for inverter operation. These include reference frequencies and acceleration or deceleration times. Frequencies will only be displayed if an LCD keypad is in use. |
| Drive | dr | Configures parameters for basic operations. These include jog operation, motor capacity evaluation, torque boost, and other keypad related parameters. |
| Basic | bA | Configures basic parameters, including motor-related parameters and multi-step frequencies. |
| Advanced | Ad | Configure acceleration or deceleration patterns and to setup frequency limits. |
| Control | Ln | Configures sensorless vector - related features. |
| Input Terminal | In | Configures input terminal-related features, including digital multi-functional inputs and analog inputs. |
| Output Terminal | OU | Configures output terminal-related features such as relays and analog outputs. |
| Communication | Co | Configures communication features for RS-485 or other communication options. |
| Application | AP | Configures PID control-related sequences and operations. |
| Protection | Pr | Configures motor or inverter protection features. |
| Motor 2 (Secondary Motor) | M2 | Configures secondary motor related features. The secondary motor (M2) group appears on the keypad only when one of the multi-function input terminals (In.65–In.71) has been set to 26 (Secondary motor). |
| User Sequence | US | Used to implement simple sequences with various function blocks. |
| User Sequence Function | UF | |

3.2 Learning to Use the Keypad

The keypad enables movement between groups and codes. It also enables users to select and configure functions. At code level, you can set parameter values to turn on or off specific functions, or decide how the functions will be used. Refer to 8 *Table of Functions* on page 249 to find the functions you need.

Confirm the correct values (or the correct range of the values), and then follow the examples below to configure the inverter with the keypad.

3.2.1 Group and Code Selection

Follow the examples below to learn how to switch between groups and codes.

| Step | Instruction | Keypad Display |
|------|---|----------------|
| 1 | Move to the group you want using the [◀] and [▶] keys. | |
| 2 | Move up and down through the codes using the [▲] and [▼] keys until you locate the code that you require. | |
| 3 | Press the [ENT] key to save the change. | - |

Note

For some settings, pressing the [▲] or [▼] key will not increase or decrease the code number by 1. Code numbers may be skipped and not be displayed. This is because certain code numbers have been intentionally left blank (or reserved) for new functions to be added in the future. Also some features may have been hidden (disabled) because a certain code has been set to disable the functions for relevant codes.

As an example, if Ad.24 (Frequency Limit) is set to 0 (No), the next codes, Ad.25 (Freq Limit Lo) and Ad.26 (Freq Limit Hi), will not be displayed. If you set code Ad.24 to 1 (Yes) and enable the frequency limit feature, codes Ad.25 and 26 will appear to allow the maximum and minimum frequency limitations to be set up.

3.2.2 Navigating Directly to Different Codes

The following example details navigating to code dr. 95, from the initial code in the Drive group (dr. 0). This example applies to all groups whenever you would like to navigate to a specific code number.

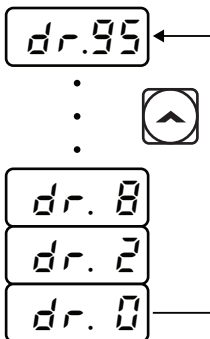

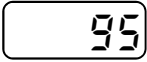
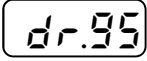

| Step | Instruction | Keypad Display |
|------|--|----------------|
| 1 | Ensure that you are currently at the first code of the Drive group (dr.0). | |
| 2 | Press the [ENT] key. Number '9' will flash. | |
| 3 | Press the [▼] key to display '5,' the first 1s' place of the group destination, '95.' | |
| 4 | Press the [◀] key to move to the 10s' place. The cursor will move to the left and '05' will be displayed. This time, the number '0' will be flashing. | |

| Step | Instruction | Keypad Display |
|------|---|---|
| 5 | Press the [▲] key to increase the number from '0' to '9,' the 10s place digit of the destination, '95.' |  |
| 6 | Press the [ENT] key. Code dr.95 is displayed. |  |

3.2.3 Setting Parameter Values

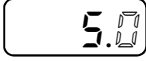
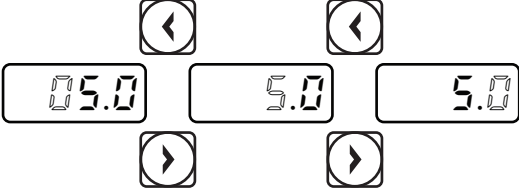
Enable or disable features by setting or modifying parameter values for different codes. Directly enter setting values, such as frequency references, supply voltages, and motor speeds. Follow the instructions below to learn to set or modify parameter values.

| Step | Instruction | Keypad Display |
|------|---|--|
| 1 | Select the group and code to setup or modify parameter settings, and then press the [ENT] key. The first number on the right side of the display will flash. |  |
| 2 | Press the [◀] or [▶] key to move the cursor to the number that you would like to modify. |  |
| 3 | Press the [▲] or [▼] key to adjust the value, and then press the [ENT] key to confirm it. The selected value will flash on the display. |  |
| 4 | Press the [ENT] key again to save the change. | - |

Note

- A flashing number on the display indicates that the keypad is waiting for an input from the user. Changes will be saved when the [ENT] key is pressed while the number is flashing. The setting change will be canceled if you press any other key.
- Each code's parameter values have default features and ranges specified. Refer to 8 *Table of Functions* on page 249 for information about the features and ranges before setting or modifying parameter values.

3.2.4 Configuring the [ESC] Key

The [ESC] key is a multi-functional key that can be configured to carry out a number of different functions. Refer to 4.6 *Local/Remote Mode Switching* on page 82 for more information about the other functions of the [ESC] key. The following example shows how to configure the [ESC] key to perform a jog operation.

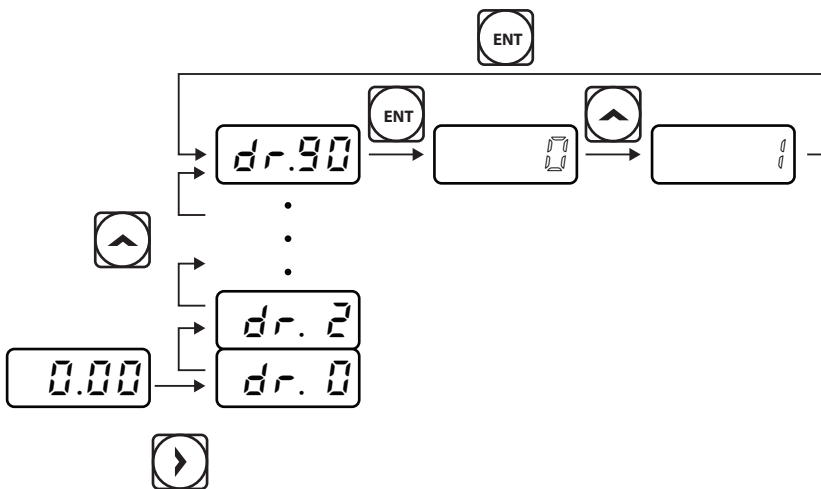

| Step | Instruction | Keypad Display |
|------|--|----------------|
| 1 | Ensure that you are currently at the first code of the Operation group, and that code 0.00 (Command Frequency) is displayed. | 0.00 |
| 2 | Press the [▶] key. You have moved to the initial code of the Drive group (dr.0). | dr.0 |
| 3 | Press the [▲] or [▼] key to select code 90 (ESC key configuration), and then press the [ENT] key. | dr.90 |

| Step | Instruction | Keypad Display |
|------|---|----------------|
| | Code dr.90 currently has an initial parameter value of, 0 (adjust to the initial position). | |
| 4 | Press the [▲] key to modify the value to 1 (Jog key) and then press the [ENT] key. The new parameter value will flash. | |
| 5 | Press the [ENT] key again to save changes. | - |

Note

- If the code dr. 90 (ESC key configuration) is set to 1 (JOG Key) or 2 (Local/Remote), the SET indicator will flash when the [ESC] key is pressed.
- The factory default setting for code dr. 90 is 0 (move to the initial position). You can navigate back to the initial position (code 0.00 of the Operation group) immediately, by pressing the [ESC] key while configuring any codes in any groups.

3.3 Actual Application Examples

3.3.1 Acceleration Time Configuration

The following is an example demonstrating how to modify the ACC (Acceleration time) code value (from 5.0 to 16.0) from the Operation group.

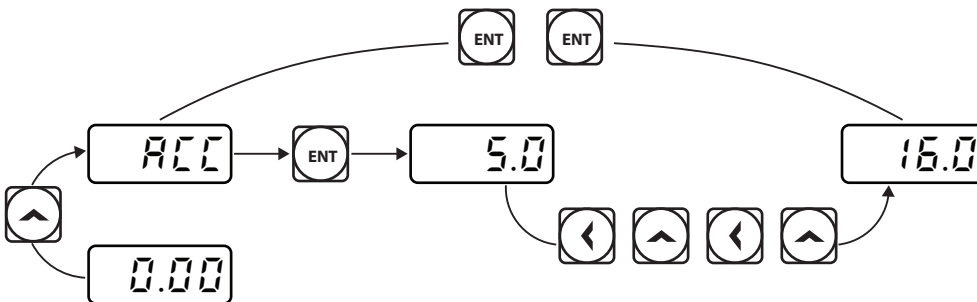

| Step | Instruction | Keypad Display |
|------|---|----------------|
| 1 | Ensure that the first code of the Operation group is selected, and code 0.00 (Command Frequency) is displayed. | 0.00 |
| 2 | Press the [▲] key. The display will change to the second code in the Operation group, the ACC (Acceleration Time) code. | ACC |
| 3 | Press the [ENT] key. The number '5.0' will be displayed, with '0' flashing. This indicates that the current acceleration time is set to 5.0 seconds. The flashing value is ready to be modified by using the keypad. | 5.0 |
| 4 | Press the [◀] key to change the first place value. '5' will be flashing now. This indicates the flashing value, '5' is ready to be modified. | 5.0 |
| 5 | Press the [▲] key to change the number '5' into '6', the first place value of the target number '16.' | 6.0 |
| 6 | Press the [◀] key to move to the 10s, place value. The number in the 10s position, '0' in '06' will start to flash | 06.0 |
| 7 | Press the [▲] key to change the number from '0' to '1', to match the 10s place value of the target number '16,' and then press the [ENT] key. Both digits will flash on the display. | 16.0 |
| 8 | Press the [ENT] key once again to save changes. 'ACC' will be displayed. The change to the acceleration time setup has been completed. | ACC |

3.3.2 Frequency Reference Configuration

The following is an example to demonstrate configuring a frequency reference of 30.05 (Hz) from the first code in the Operation group (0.00).



| Step | Instruction | Keypad Display |
|------|--|----------------|
| 1 | Ensure that the first code of the Operation group is selected, and the code 0.00 (Command Frequency) is displayed. | |
| 2 | Press the [ENT] key. The value, 0.00 will be displayed with the '0' in the 1/100s place value flashing. | |
| 3 | Press the [◀] key 3 times to move to the 10s place value. The '0' at the 10s place value will start to flash. | |
| 4 | Press the [▲] key to change it to '3,' the 10s place value of the target frequency, '30.05.' | |
| 5 | Press the [▶] key 3 times. The '0' at the 1/100s place position will flash. | |
| 6 | Press the [▲] key to change it to '5,' the 1/100 place value of the target frequency, '30.05,' and then press the [ENT] key. The parameter value will flash on the display. | |
| 7 | Press the [ENT] key once again to save changes. Flashing stops. The frequency reference has been configured to 30.05 Hz. | |

Note

- A flashing number on the display indicates that the keypad is waiting for an input from the user. Changes are saved when the [ENT] key is pressed while the value is flashing. Changes will be canceled if any other key is pressed.
- The S100 inverter keypad display can display up to 4 digits. However, 5-digit figures can be used and are accessed by pressing the [◀] or [▶] key, to allow keypad input.

3.3.3 Jog Frequency Configuration

The following example demonstrates how to configure Jog Frequency by modifying code 11 in the Drive group (Jog Frequency) from 10.00(Hz) to 20.00(Hz). You can configure the parameters for different codes in any other group in exactly the same way.

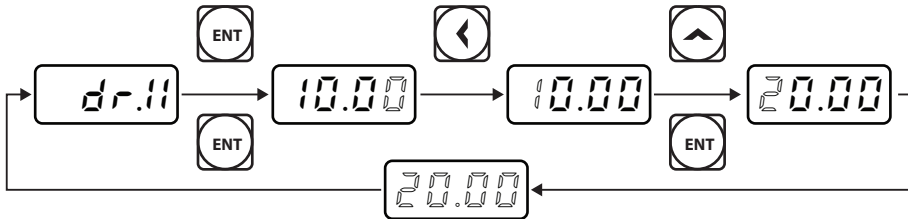

| Step | Instruction | Keypad Display |
|------|---|----------------|
| 1 | Go to code 11(Jog Frequency) in the Drive group. | |
| 2 | Press the [ENT] key. The current Jog Frequency value (10.00) for code dr.11 is displayed. | |
| 3 | Press the [◀] key 3 times to move to the 10s place value. Number '1' at the 10s place position will flash. | |
| 4 | Press the [▲] key to change the value to '2,' to match the 10s place value of the target value'20.00,' and then press the [ENT] key. All parameter digits will flash on the display. | |
| 5 | Press the [ENT] key once again to save the changes. Code dr.11 will be displayed. The parameter change has been completed. | |

3.3.4 Initializing All Parameters

The following example demonstrates parameter initialization using code dr.93 (Parameter Initialization) in the Drive group. Once executed, parameter initialization will delete all modified values for all codes and groups.

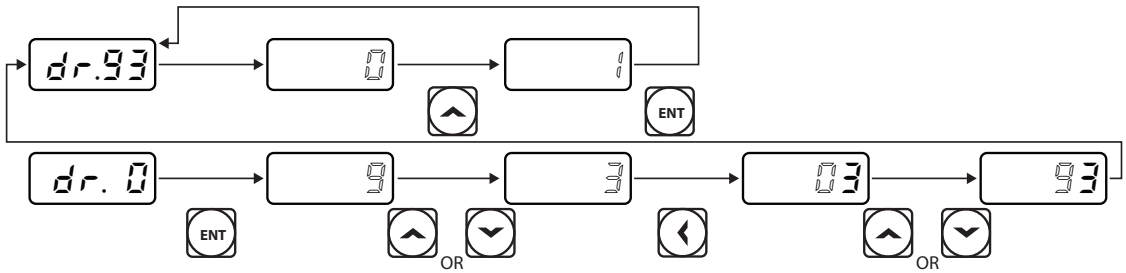

| Step | Instruction | Keypad Display |
|------|--|--------------------|
| 1 | Go to code 0 (Jog Frequency) in the Drive group. | <code>dr.0</code> |
| 2 | Press the [ENT] key. The current parameter value (9) will be displayed. | <code>9</code> |
| 3 | Press the [q] key to change the first place value to '3' of the target code, '93.' | <code>3</code> |
| 4 | Press the [◀] key to move to the 10s place position. '03' will be displayed. | <code>03</code> |
| 5 | Press the [▲] or [▼] key to change the '0' to '9' of the target code, '93.' | <code>93</code> |
| 6 | Press the [ENT] key. Code dr.93 will be displayed. | <code>dr.93</code> |
| 7 | Press the [ENT] key once again. The current parameter value for code dr.93 is set to 0 (Do not initialize). | <code>0</code> |
| 8 | Press the [▲] key to change the value to 1 (All Grp), and then press the [ENT] key. The parameter value will flash. | <code>1</code> |
| 9 | Press the [ENT] key once again. Parameter initialization begins. Parameter initialization is complete when code dr.93 reappears on the display. | <code>dr.93</code> |

Note

Following parameter initialization, all parameters are reset to factory default values. Ensure that parameters are reconfigured before running the inverter again after an initialization.

3.3.5 Frequency Setting (Keypad) and Operation (via Terminal Input)

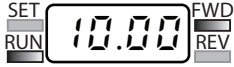
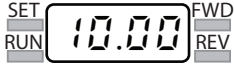
| Step | Instruction | Keypad Display |
|------|--|--|
| 1 | Turn on the inverter. | - |
| 2 | Ensure that the first code of the Operation group is selected, and code 0.00 (Command Frequency) is displayed, then press the [ENT] key. The first digit on the right will flash. | 0.00 |
| 3 | Press the [◀] key 3 times to go to the 10s place position. The number '0' at the 10s place position will flash. | 00.00 |
| 4 | Press the [▲] key to change it to 1, and then press the [ENT] key. The parameter value (10.00) will flash. | 10.00 |
| 5 | Press the [ENT] key once again to save changes. A change of reference frequency to 10.00 Hz has been completed. | 10.00 |
| 6 | Refer to the wiring diagram at the bottom of the table, and close the switch between the P1 (FX) and CM terminals. The RUN indicator light flashes and the FWD indicator light comes on steady. The current acceleration frequency is displayed. |  |
| 7 | When the frequency reference is reached (10Hz), open the switch between the P1 (FX) and CM terminals. The RUN indicator light flashes again and the current deceleration frequency is displayed. When the frequency reaches 0Hz, the RUN and FWD indicator lights turn off, and the frequency reference (10.00Hz) is displayed again. |  |

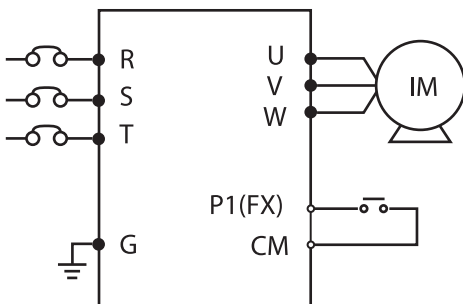

[Wiring Diagram]

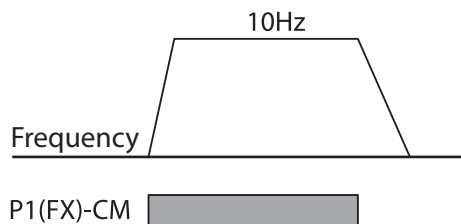

[Operation Pattern]

Note

The instructions in the table are based on the factory default parameter settings. The inverter may not work correctly if the default parameter settings are changed after the inverter is purchased. In such cases, initialize all parameters to reset the values to factory default parameter settings before following the instructions in the table (refer to [5.22 Parameter Initialization](#) on page 171).

3.3.6 Frequency Setting (Potentiometer) and Operation (Terminal Input)

| Step | Instruction | Keypad Display |
|------|--|----------------|
| 1 | Turn on the inverter. | - |
| 2 | Ensure that the first code of the Operation group is selected, and the code 0.00 (Command Frequency) is displayed. | |
| 3 | Press the [▲] key 4 times to go to the Frq (Frequency reference source) code. | |
| 4 | Press the [ENT] key. The Frq code in the Operation group is currently set to 0 (keypad). | |
| 5 | Press the [▲] key to change the parameter value to 2 (Potentiometer), and then press the [ENT] key. The new parameter value will flash. | |
| 6 | Press the [ENT] key once again. The Frq code will be displayed again. The frequency input has been configured for the potentiometer. | |
| 7 | Press the [▼] key 4 times. Returns to the first code of the Operation group (0.00). From here frequency setting values can be monitored. | |
| 8 | Adjust the potentiometer to increase or decrease the frequency reference to 10Hz. | - |
| 9 | Refer to the wiring diagram at the bottom of the table, and close the switch between the P1 (FX) and CM terminals. The RUN indicator light flashes and the FWD indicator light comes on steady. The current acceleration frequency is displayed. | |
| 10 | When the frequency reference is reached (10Hz), open the switch between the P1 (FX) and CM terminals. The RUN indicator light flashes again and the current deceleration frequency is displayed. When the frequency reaches 0Hz, the RUN and FWD indicators turn off, and the frequency reference (10.00Hz) is displayed again. | |

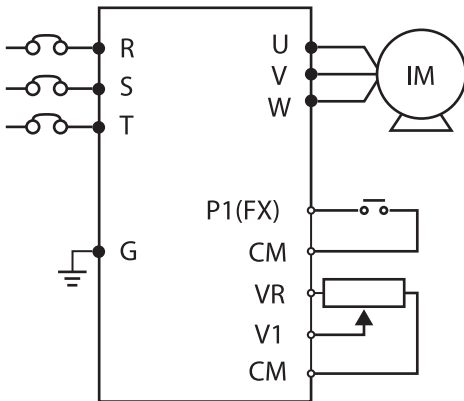

[Wiring Diagram]

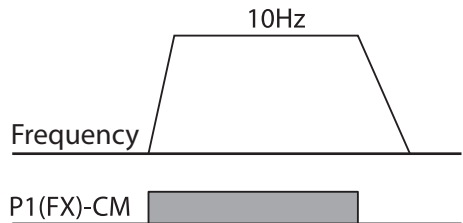

[Operation Pattern]

Note

The instructions in the table are based on the factory default parameter settings. The inverter may not work correctly if the default parameter settings are changed after the inverter is purchased. In such cases, initialize all parameters to reset the factory default parameter settings before following the instructions in the table (refer to [5.22 Parameter Initialization](#) on page 171).

3.3.7 Frequency Setting (Potentiometer) and Operation (Keypad)

| Step | Instruction | Keypad Display |
|------|---|----------------|
| 1 | Turn on the inverter. | - |
| 2 | Ensure that the first code of the Operation group is selected, and the code 0.00 (Command Frequency) is displayed. | 0.00 |
| 3 | Press the [▲] key 4 times to go to the drv code. | drv |
| 4 | Press the [ENT] key. The drv code in the Operation group is currently set to 1 (Analog Terminal). | 1 |
| 5 | Press the [▼] key to change the parameter value to 0 (Keypad), and then press the [ENT] key. The new parameter value will flash. | 0 |
| 6 | Press the [ENT] key once again. The drv code is displayed again. The frequency input has been configured for the keypad. | drv |
| 7 | Press the [▲] key. To move to the Frq (Frequency reference source) code. | Frq |

| Step | Instruction | Keypad Display |
|------|---|----------------|
| 8 | Press the [ENT] key. The Frq code in the Operation group is set to 0 (Keypad). | |
| 9 | Press the [▲] key to change it to 2 (Potentiometer), and then press the [ENT] key. The new parameter value will flash. | |
| 10 | Press the [ENT] key once again. The Frq code is displayed again. The frequency input has been configured for potentiometer. | |
| 11 | Press the [▼] key 4 times. Returns to the first code of the Operation group (0.00). From here frequency setting values can be monitored. | |
| 12 | Adjust the potentiometer to increase or decrease the frequency reference to 10Hz. | - |
| 13 | Press the [RUN] key on the keypad. The RUN indicator light flashes and the FWD indicator light comes on steady. The current acceleration frequency is displayed. | |
| 14 | When the frequency reaches the reference (10Hz), press the [STOP/RESET] key on the keypad. The RUN indicator light flashes again and the current deceleration frequency is displayed. When the frequency reaches 0Hz, the RUN and FWD indicator lights turn off, and the frequency reference (10.00Hz) is displayed again. | |

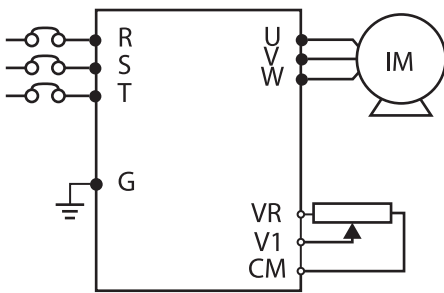

[Wiring Diagram]

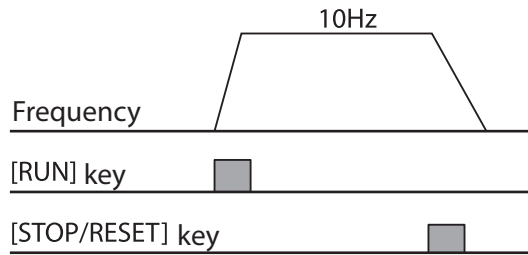

[Operation Pattern]

Note

The instructions in the table are based on the factory default parameter settings. The inverter may not work correctly if the default parameter settings are changed after the inverter is purchased. In such cases, initialize all parameters to reset the factory default parameter settings before following the instructions in the table (refer to [5.22 Parameter Initialization](#) on page 171).

3.4 Monitoring the Operation

3.4.1 Output Current Monitoring

The following example demonstrates how to monitor the output current in the Operation group using the keypad.

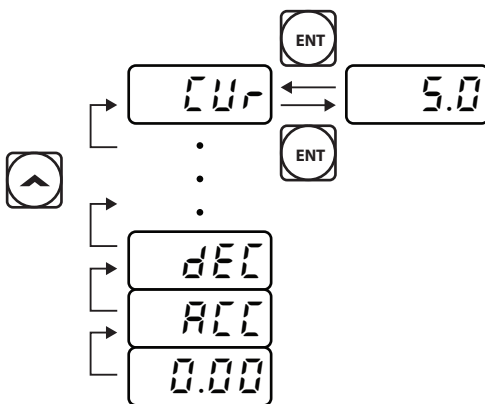

| Step | Instruction | Keypad Display |
|------|--|----------------|
| 1 | Ensure that the first code of the Operation group is selected, and the code 0.00 (Command Frequency) is displayed. | 0.00 |
| 2 | Press the [▲] or [▼] key to move to the Cur code. | Cur |
| 3 | Press the [ENT] key. The output current (5.0A) is displayed. | 5.0 |
| 4 | Press the [ENT] key again. Returns to the Cur code. | Cur |

Note

You can use the dCL (DC link voltage monitor) and vOL (output voltage monitor) codes in the Operation group in exactly the same way as shown in the example above, to monitor each function's relevant values.

3.4.2 Fault Trip Monitoring

The following example demonstrates how to monitor fault trip conditions in the Operation group using the keypad.

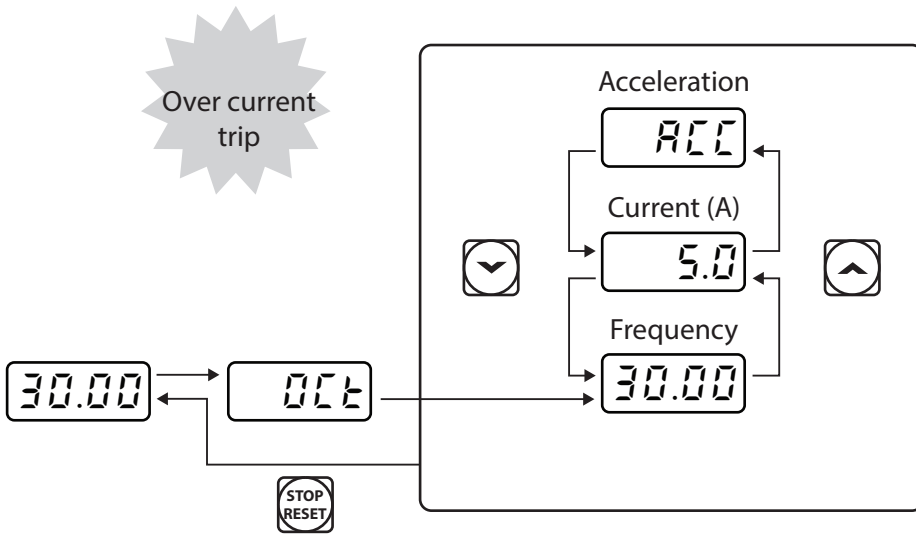

| Step | Instruction | Keypad Display |
|------|---|----------------|
| 1 | Refer to the example keypad display. An over current trip fault has occurred. | |
| 2 | Press the [ENT] key, and then the [▲] key. The operation frequency at the time of the fault (30.00Hz) is displayed. | |
| 3 | Press the [▲] key. The output current at the time of the fault (5.0A) is displayed. | |
| 4 | Press the [▲] key. The operation status at the time of the fault is displayed. ACC on the display indicates that the fault occurred during acceleration. | |
| 5 | Press the [STOP/RESET] key. The inverter resets and the fault condition is cleared. The frequency reference is displayed on the keypad. | |

Note

- If multiple fault trips occur at the same time, a maximum of 3 fault trip records can be retrieved as shown in the following example.

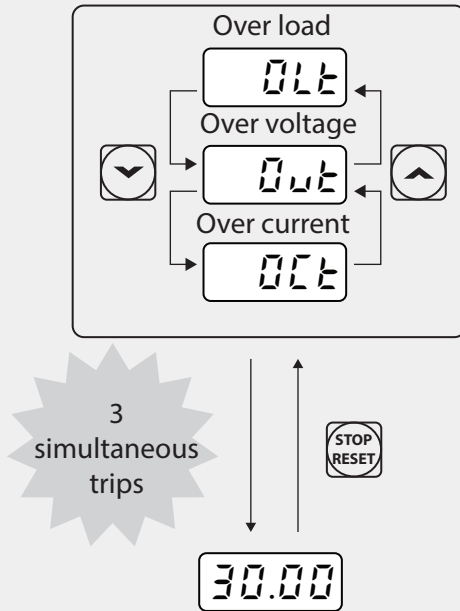

- If a warning condition occurs while running at a specified frequency, the current frequency and the `!Arrn` signal will be displayed alternately, at 1 second intervals. Refer to [6.3 Under load Fault Trip and Warning](#) on page 209 for more details.

4 Learning Basic Features

This chapter describes the basic features of the S100 inverter. Check the reference page in the table to see the detailed description for each of the advanced features.

| Basic Tasks | Description | Ref. |
|---|--|--|
| Frequency reference source configuration for the keypad | Configures the inverter to allow you to setup or modify frequency reference using the Keypad. | p.66 |
| Frequency reference source configuration for the terminal block (input voltage) | Configures the inverter to allow input voltages at the terminal block (V1, V2) and to setup or modify a frequency reference. | p.67 , p.74 |
| Frequency reference source configuration for the terminal block (input current) | Configures the inverter to allow input currents at the terminal block (I2) and to setup or modify a frequency reference. | p.72 |
| Frequency reference source configuration for the terminal block (input pulse) | Configures the inverter to allow input pulse at the terminal block (TI) and to setup or modify a frequency reference. | p.74 |
| Frequency reference source configuration for RS-485 communication | Configures the inverter to allow communication signals from upper level controllers, such as PLCs or PCs, and to setup or modify a frequency reference. | p.76 |
| Frequency control using analog inputs | Enables the user to hold a frequency using analog inputs at terminals. | p.77 |
| Motor operation display options | Configures the display of motor operation values. Motor operation is displayed either in frequency (Hz) or speed (rpm). | p.77 |
| Multi-step speed (frequency) configuration | Configures multi-step frequency operations by receiving an input at the terminals defined for each step frequency. | p.77 |
| Command source configuration for keypad buttons | Configures the inverter to allow the manual operation of the [FWD], [REV] and [Stop] keys. | p.80 |
| Command source configuration for terminal block inputs | Configures the inverter to accept inputs at the FX/RX terminals. | p.80 |
| Command source configuration for RS-485 communication | Configures the inverter to accept communication signals from upper level controllers, such as PLCs or PCs. | p.82 |
| Local/remote switching via the [ESC] key | Configures the inverter to switch between local and remote operation modes when the [ESC] key is pressed. When the inverter is operated using remote inputs (any input other than one from the keypad), this configuration can be used to perform maintenance on the inverter, without losing or altering saved parameter settings. It can also be used to override remotes and use the keypad immediately in emergencies. | p.82 |

| Basic Tasks | Description | Ref. |
|--|---|----------------------|
| Motor rotation control | Configures the inverter to limit a motor's rotation direction. | p.84 |
| Automatic start-up at power-on | Configures the inverter to start operating at power-on. With this configuration, the inverter begins to run and the motor accelerates as soon as power is supplied to the inverter. To use automatic start-up configuration, the operation command terminals at the terminal block must be turned on. | p.85 |
| Automatic restart after reset of a fault trip condition | Configures the inverter to start operating when the inverter is reset following a fault trip. In this configuration, the inverter starts to run and the motor accelerates as soon as the inverter is reset following a fault trip condition. For automatic start-up configuration to work, the operation command terminals at the terminal block must be turned on. | p.85 |
| Acc/Dec time configuration based on the Max. Frequency | Configures the acceleration and deceleration times for a motor based on a defined maximum frequency. | p.87 |
| Acc/Dec time configuration based on the frequency reference | Configures acceleration and deceleration times for a motor based on a defined frequency reference. | p.88 |
| Multi-stage Acc/Dec time configuration using the multi-function terminal | Configures multi-stage acceleration and deceleration times for a motor based on defined parameters for the multi-function terminals. | p.89 |
| Acc/Dec time transition speed (frequency) configuration | Enables modification of acceleration and deceleration gradients without configuring the multi-functional terminals. | p.91 |
| Acc/Dec pattern configuration | Enables modification of the acceleration and deceleration gradient patterns. Basic patterns to choose from include linear and S-curve patterns. | p.91 |
| Acc/Dec stop command | Stops the current acceleration or deceleration and controls motor operation at a constant speed. Multi-function terminals must be configured for this command . | p.94 |
| Linear V/F pattern operation | Configures the inverter to run a motor at a constant torque. To maintain the required torque, the operating frequency may vary during operation. | p.94 |
| Square reduction V/F pattern operation | Configures the inverter to run the motor at a square reduction V/F pattern. Fans and pumps are appropriate loads for square reduction V/F operation. | p.95 |
| User V/F pattern configuration | Enables the user to configure a V/F pattern to match the characteristics of a motor. This configuration is for special-purpose motor applications to achieve optimal performance. | p.96 |
| Manual torque boost | Manual configuration of the inverter to produce a momentary torque boost. This configuration is for loads that require a large amount of starting torque, such as elevators or lifts. | p.97 |
| Automatic torque boost | Automatic configuration of the inverter that provides "auto tuning" that produces a momentary torque boost. This | p.98 |

| Basic Tasks | Description | Ref. |
|---|---|-----------------------|
| | configuration is for loads that require a large amount of starting torque, such as elevators or lifts. | |
| Output voltage adjustment | Adjusts the output voltage to the motor when the power supply to the inverter differs from the motor's rated input voltage. | p.99 |
| Accelerating start | Accelerating start is the general way to start motor operation. The typical application configures the motor to accelerate to a target frequency in response to a run command, however there may be other start or acceleration conditions defined. | p.100 |
| Start after DC braking | Configures the inverter to perform DC braking before the motor starts rotating again. This configuration is used when the motor will be rotating before the voltage is supplied from the inverter. | p.100 |
| Deceleration stop | Deceleration stop is the typical method used to stop a motor. The motor decelerates to 0Hz and stops on a stop command, however there may be other stop or deceleration conditions defined. | p.101 |
| Stopping by DC braking | Configures the inverter to apply DC braking during motor deceleration. The frequency at which DC braking occurs must be defined and during deceleration, when the motor reaches the defined frequency, DC braking is applied. | p.101 |
| Free-run stop | Configures the inverter to stop output to the motor using a stop command. The motor will free-run until it slows down and stops. | p.102 |
| Power braking | Configures the inverter to provide optimal, motor deceleration, without tripping over-voltage protection. | p.103 |
| Start/maximum frequency configuration | Configures the frequency reference limits by defining a start frequency and a maximum frequency. | p.104 |
| Upper/lower frequency limit configuration | Configures the frequency reference limits by defining an upper limit and a lower limit. | p.104 |
| Frequency jump | Configures the inverter to avoid running a motor in mechanically resonating frequencies. | p.105 |
| 2 nd Operation Configuration | Used to configure the 2 nd operation mode and switch between the operation modes according to your requirements. | p.106 |
| Multi-function input terminal control configuration | Enables the user to improve the responsiveness of the multi-function input terminals. | p.107 |
| P2P communication configuration | Configures the inverter to share input and output devices with other inverters. | p.109 |
| Multi-keypad configuration | Enables the user to monitor multiple inverters with one monitoring device. | p.109 |
| User sequence configuration | Enables the user to implement simple sequences using various function blocks. | p.111 |

4.1 Setting Frequency Reference

The S100 inverter provides several methods to setup and modify a frequency reference for an operation. The keypad, analog inputs [for example voltage (V1, V2) and current (I2) signals], or RS-485 (digital signals from higher-level controllers, such as PC or PLC) can be used. If UserSeqLink is selected, the common area can be linked with user sequence output and can be used as frequency reference.

| Group | Code | Name | LCD Display | Parameter Setting | | Setting Range | Unit |
|-----------|------|----------------------------|--------------|-------------------|-------------|---------------|------|
| Operation | Frq | Frequency reference source | Ref Freq Src | 0 | KeyPad-1 | 0-12 | - |
| | | | | 1 | KeyPad-2 | | |
| | | | | 2 | V1 | | |
| | | | | 4 | V2 | | |
| | | | | 5 | I2 | | |
| | | | | 6 | Int 485 | | |
| | | | | 8 | Field Bus | | |
| | | | | 9 | UserSeqLink | | |
| | | | | 12 | Pulse | | |

4.1.1 Keypad as the Source (KeyPad-1 setting)

You can modify frequency reference by using the keypad and apply changes by pressing the [ENT] key. To use the keypad as a frequency reference input source, go to the Frq (Frequency reference source) code in the Operation group and change the parameter value to 0 (Keypad-1). Input the frequency reference for an operation at the 0.00(Command Frequency) code in the Operation group.)

| Group | Code | Name | LCD Display | Parameter Setting | | Setting Range | Unit |
|-----------|------|----------------------------|--------------|-------------------|----------|-----------------|------|
| Operation | Frq | Frequency reference source | Freq Ref Src | 0 | KeyPad-1 | 0-12 | |
| | 0.00 | Frequency reference | | 0.00 | | Min to Max Frq* | Hz |

* You cannot set a frequency reference that exceeds the Max. Frequency, as configured with dr.20.

4.1.2 Keypad as the Source (KeyPad-2 setting)

You can use the [▲] and [▼] keys to modify a frequency reference. To use this as a second option, set the keypad as the source of the frequency reference, by going to the Frq (Frequency reference source) code in the Operation group and change the parameter value to 1 (Keypad-2). This allows frequency reference values to be increased or decreased by pressing the [▲] and [▼] keys.

| Group | Code | Name | LCD Display | Parameter Setting | | Setting Range | Unit |
|-----------|------|----------------------------|--------------|-------------------|----------|-----------------|------|
| Operation | Frq | Frequency reference source | Freq Ref Src | 1 | KeyPad-2 | 0-12 | - |
| | 0.00 | Frequency reference | | 0.00 | | Min to Max Frq* | Hz |

* You cannot set a frequency reference that exceeds the Max. Frequency, as configured with dr.20.

4.1.3 V1 Terminal as the Source

You can set and modify a frequency reference by setting voltage inputs when using the V1 terminal. Use voltage inputs ranging from 0 to 10V (unipolar) for forward only operation. Use voltage inputs ranging from -10 to +10V (bipolar) for both directions, where negative voltage inputs are used reverse operations.

4.1.3.1 Setting a Frequency Reference for 0-10V Input

Set code 06 (V1 Polarity) to 0 (unipolar) in the Input Terminal group (IN). Use a voltage output from an external source or use the voltage output from the VR terminal to provide inputs to V1. Refer to the diagrams below for the wiring required for each application.



[External source application] [Internal source (VR) application]

| Group | Code | Name | LCD Display | Parameter Setting | | Setting Range | Unit |
|-----------|------|-----------------------------------|----------------|-------------------|----------|----------------------|------|
| Operation | Frq | Frequency reference source | Freq Ref Src | 2 | V1 | 0-12 | - |
| In | 01 | Frequency at maximum analog input | Freq at 100% | Maximum frequency | | 0.00- Max. Frequency | Hz |
| | 05 | V1 input monitor | V1 Monitor [V] | 0.00 | | 0.00-12.00 | V |
| | 06 | V1 polarity options | V1 Polarity | 0 | Unipolar | 0-1 | - |

| Group | Code | Name | LCD Display | Parameter Setting | Setting Range | Unit |
|-------|------|----------------------------------|---------------|-------------------|-------------------|------|
| | 07 | V1 input filter time constant | V1 Filter | 10 | 0–10000 | ms |
| | 08 | V1 minimum input voltage | V1 volt x1 | 0.00 | 0.00–10.00 | V |
| | 09 | V1 output at minimum voltage (%) | V1 Perc y1 | 0.00 | 0.00–100.00 | % |
| | 10 | V1 maximum input voltage | V1 Volt x2 | 10.00 | 0.00– 12.00 | V |
| | 11 | V1 output at maximum voltage (%) | V1 Perc y2 | 100.00 | 0–100 | % |
| | 16 | Rotation direction options | V1 Inverting | 0 No | 0–1 | - |
| | 17 | V1 Quantizing level | V1 Quantizing | 0.04 | 0.00*, 0.04–10.00 | % |

* Quantizing is disabled if '0' is selected.

0–10V Input Voltage Setting Details

| Code | Description |
|---------------------|--|
| In.01 Freq at 100% | <p>Configures the frequency reference at the maximum input voltage when a potentiometer is connected to the control terminal block. A frequency set with code In.01 becomes the maximum frequency only if the value set in code In.11 (or In.15) is 100(%).</p> <ul style="list-style-type: none"> Set code In.01 to 40.00 and use default values for codes In.02–In.16. Motor will run at 40.00Hz when a 10V input is provided at V1. Set code In.11 to 50.00 and use default values for codes In.01–In.16. Motor will run at 30.00Hz (50% of the default maximum frequency–60Hz) when a 10V input is provided at V1. |
| In.05 V1 Monitor[V] | Configures the inverter to monitor the input voltage at V1. |
| In.07 V1 Filter | <p>V1 Filter may be used when there are large variations between reference frequencies. Variations can be mitigated by increasing the time constant, but this will require an increased response time.</p> <p>The value t (time) indicates the time required for the frequency to reach 63% of the reference, when external input voltages are provided in multiple steps.</p> |

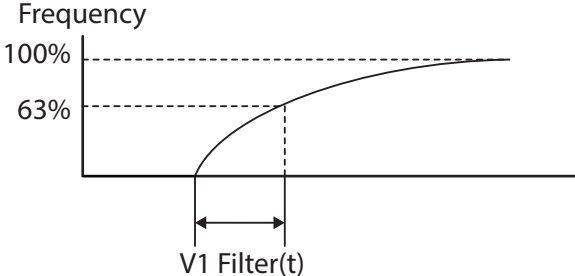
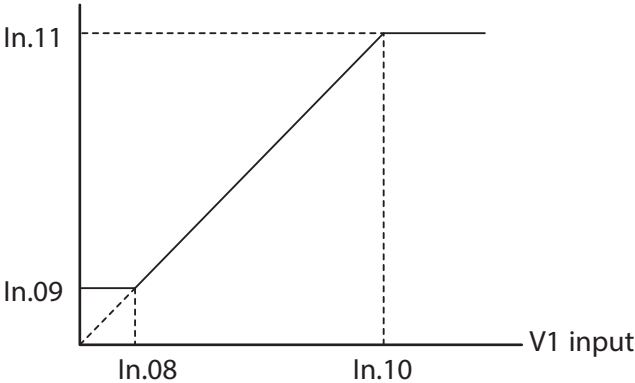
| Code | Description |
|---|---|
| | <p>V1 input from external source </p>  <p>[V1 Filter]</p> |
| <p>In.08 V1 Volt x1– In.11 V1 Perc y2</p> | <p>These parameters are used to configure the gradient level and offset values of the Output Frequency, based on the Input Voltage.</p> <p>Frequency reference</p>  <p>[Volt x1–In.11 V1 Perc y2]</p> |
| <p>In.16 V1 Inverting</p> | <p>Inverts the direction of rotation. Set this code to 1 (Yes) if you need the motor to run in the opposite direction from the current rotation.</p> |
| <p>In.17.V1 Quantizing</p> | <p>Quantizing may be used when the noise level is high in the analog input (V1 terminal) signal.</p> <p>Quantizing is useful when you are operating a noise-sensitive system, because it suppresses any signal noise. However, quantizing will diminish system sensitivity (resultant power of the output frequency will decrease based on the analog input).</p> <p>You can also turn on the low-pass filter using code In.07 to reduce the noise, but increasing the value will reduce responsiveness and may cause pulsations (ripples) in the output frequency.</p> |

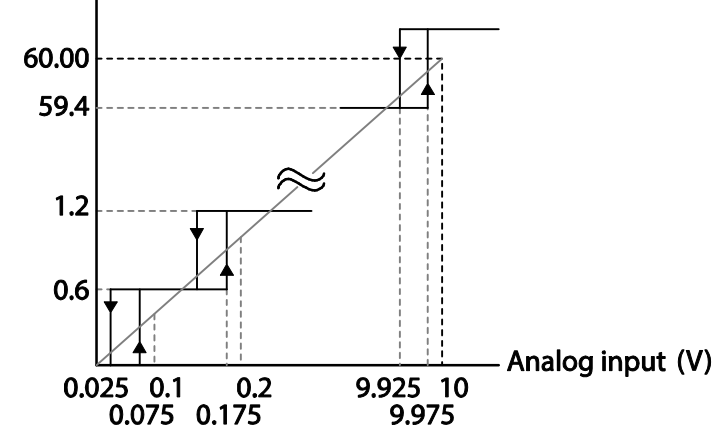
| Code | Description |
|------|---|
| | <p>Parameter values for quantizing refer to a percentage based on the maximum input. Therefore, if the value is set to 1% of the analog maximum input (60Hz), the output frequency will increase or decrease by 0.6Hz per 0.1V difference.</p> <p>When the analog input is increased, an increase to the input equal to 75% of the set value will change the output frequency, and then the frequency will increase according to the set value. Likewise, when the analog input decreases, a decrease in the input equal to 75% of the set value will make an initial change to the output frequency.</p> <p>As a result, the output frequency will be different at acceleration and deceleration, mitigating the effect of analog input changes over the output frequency.</p> <p>Output frequency (Hz)</p>  <p>Analog input (V)</p> <p>[V1 Quantizing]</p> |

4.1.3.2 Setting a Frequency Reference for -10–10V Input

Set the Frq (Frequency reference source) code in the Operation group to 2 (V1), and then set code 06 (V1 Polarity) to 1 (bipolar) in the Input Terminal group (IN). Use the output voltage from an external source to provide input to V1.

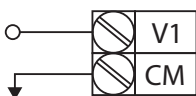

[V1 terminal wiring]

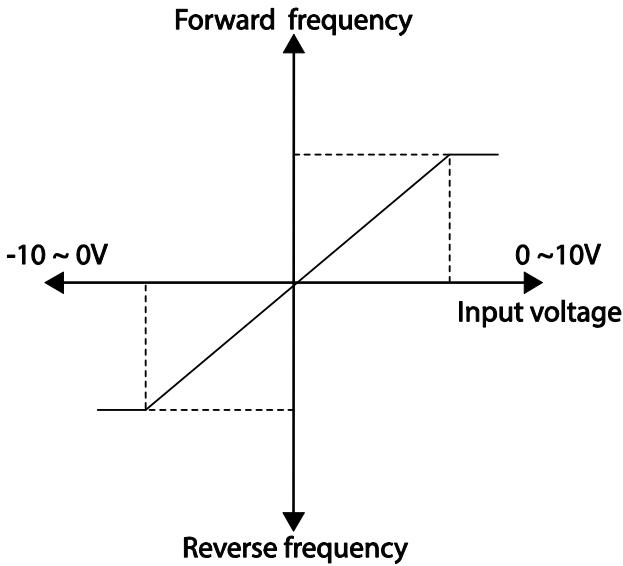

[Bipolar input voltage and output frequency]

| Group | Code | Name | LCD Display | Parameter Setting | Setting Range | Unit |
|-----------|------|-----------------------------------|--------------|-------------------|------------------|------|
| Operation | Frq | Frequency reference source | Freq Ref Src | 2 V1 | 0-12 | - |
| In | 01 | Frequency at maximum analog input | Freq at 100% | 60.00 | 0- Max Frequency | Hz |
| | 05 | V1 input monitor | V1 Monitor | 0.00 | 0.00-12.00V | V |
| | 06 | V1 polarity options | V1 Polarity | 1 Bipolar | 0-1 | - |
| | 12 | V1 minimum input voltage | V1- volt x1 | 0.00 | 10.00-0.00V | V |
| | 13 | V1 output at minimum voltage (%) | V1- Perc y1 | 0.00 | -100.00-0.00% | % |
| | 14 | V1 maximum input voltage | V1- Volt x2 | -10.00 | -12.00-0.00V | V |
| | 15 | V1 output at maximum voltage (%) | V1- Perc y2 | -100.00 | -100.00-0.00% | % |

Rotational Directions for Different Voltage Inputs

| Command / Voltage Input | Input voltage | |
|-------------------------|---------------|---------|
| | 0-10V | -10-0V |
| FWD | Forward | Reverse |
| REV | Reverse | Forward |

-10–10V Voltage Input Setting Details

| Code | Description |
|---|--|
| In.12 V1- volt x1– In.15 V1- Perc y2 | <p>Sets the gradient level and off-set value of the output frequency in relation to the input voltage. These codes are displayed only when In.06 is set to 1 (bipolar). As an example, if the minimum input voltage (at V1) is set to -2 (V) with 10% output ratio, and the maximum voltage is set to -8 (V) with 80% output ratio respectively, the output frequency will vary within the range of 6 - 48 Hz.</p> <p>[In.12 V1-volt X1–In.15 V1 Perc y]</p> <p>For details about the 0–+10V analog inputs, refer to the code descriptions In.08 V1 volt x1–In.11 V1 Perc y2 on page 69.</p> |

4.1.3.3 Setting a Reference Frequency using Input Current (I2)

You can set and modify a frequency reference using input current at the I2 terminal after selecting current input at SW 2. Set the Frq (Frequency reference source) code in the Operation group to 5 (I2) and apply 4–20mA input current to I2.

| Group | Code | Name | LCD Display | Parameter Setting | Setting Range | Unit |
|-----------|------|-----------------------------------|--------------|-------------------|----------------------|------|
| Operation | Frq | Frequency reference source | Freq Ref Src | 5 I2 | 0-12 | - |
| In | 01 | Frequency at maximum analog input | Freq at 100% | 60.00 | 0- Maximum Frequency | Hz |
| | 50 | I2 input monitor | I2 Monitor | 0.00 | 0.00-24.00 | mA |
| | 52 | I2 input filter time constant | I2 Filter | 10 | 0-10000 | ms |
| | 53 | I2 minimum input current | I2 Curr x1 | 4.00 | 0.00-20.00 | mA |

| Group | Code | Name | LCD Display | Parameter Setting | Setting Range | Unit | |
|-------|------|----------------------------------|---------------|-------------------|----------------|------|---|
| | 54 | I2 output at minimum current (%) | I2 Perc y1 | 0.00 | 0-100 | % | |
| | 55 | I2 maximum input current | I2 Curr x2 | 20.00 | 0.00-24.00 | mA | |
| | 56 | I2 output at maximum current (%) | I2 Perc y2 | 100.00 | 0.00-100.00 | % | |
| | 61 | I2 rotation direction options | I2 Inverting | 0 | No | 0-1 | - |
| | 62 | I2 Quantizing level | I2 Quantizing | 0.04 | 0*, 0.04-10.00 | % | |

* Quantizing is disabled if '0' is selected.

Input Current (I2) Setting Details

| Code | Description |
|---------------------------------------|---|
| In.01 Freq at 100% | <p>Configures the frequency reference for operation at the maximum current (when In.56 is set to 100%).</p> <ul style="list-style-type: none"> If In.01 is set to 40.00Hz, and default settings are used for In.53-56, 20mA input current (max) to I2 will produce a frequency reference of 40.00Hz. If In.56 is set to 50.00 (%), and default settings are used for In.01 (60Hz) and In.53-55, 20mA input current (max) to I2 will produce a frequency reference of 30.00Hz (50% of 60Hz). |
| In.50 I2 Monitor | Used to monitor input current at I2. |
| In.52 I2 Filter | Configures the time for the operation frequency to reach 63% of target frequency based on the input current at I2. |
| In.53 I2 Curr x1- In.56 I2 Perc y2 | <p>Configures the gradient level and off-set value of the output frequency.</p> <p>Frequency Reference</p> <p>[Gradient and off-set configuration based on output frequency]</p> |

4.1.4 Setting a Frequency Reference with Input Voltage (Terminal I2)

Set and modify a frequency reference using input voltage at I2 (V2) terminal by setting SW2 to V2. Set the Frq (Frequency reference source) code in the Operation group to 4 (V2) and apply 0-12V input voltage to I2 (=V2, Analog current/voltage input terminal). Codes In.35-47 will not be displayed when I2 is set to receive current input (Frq code parameter is set to 5).

| Group | Code | Name | LCD Display | Parameter Setting | | Setting Range | Unit |
|-----------|------|--------------------------------|---------------|-------------------|----|-------------------|------|
| Operation | Frq | Frequency reference source | Freq Ref Src | 4 | V2 | 0-12 | - |
| In | 35 | V2 input display | V2 Monitor | 0.00 | | 0.00-12.00 | V |
| | 37 | V2 input filter time constant | V2 Filter | 10 | | 0-10000 | ms |
| | 38 | Minimum V2 input voltage | V2 Volt x1 | 0.00 | | 0.00-10.00 | V |
| | 39 | Output% at minimum V2 voltage | V2 Perc y1 | 0.00 | | 0.00-100.00 | % |
| | 40 | Maximum V2 input voltage | V2 Volt x2 | 10.00 | | 0.00-10.00 | V |
| | 41 | Output% at maximum V2 voltage | V2 Perc y2 | 100.00 | | 0.00-100.00 | % |
| | 46 | Invert V2 rotational direction | V2 Inverting | 0 | No | 0-1 | - |
| | 47 | V2 quantizing level | V2 Quantizing | 0.04 | | 0.00*, 0.04-10.00 | % |

* Quantizing is disabled if '0' is selected.

4.1.5 Setting a Frequency with TI Pulse Input

Set a frequency reference by setting the Frq (Frequency reference source) code in Operation group to 12 (Pulse). In case of Standard I/O, set the In.69 P5 Define to 54(TI) and providing 0-32.00kHz pulse frequency to P5.

| Group | Code | Name | LCD Display | Parameter Setting | | Setting Range | Unit |
|-----------|------|-----------------------------------|--------------|-------------------|-------|----------------------------|------|
| Operation | Frq | Frequency reference source | Freq Ref Src | 12 | Pulse | 0-12 | - |
| In | 69 | P5 terminal function setting | P5 Define | 54 | TI | 0-54 | - |
| | 01 | Frequency at maximum analog input | Freq at 100% | 60.00 | | 0.00- Maximum frequency | Hz |

| Group | Code | Name | LCD Display | Parameter Setting | Setting Range | Unit |
|-------|------|---------------------------------|---------------|-------------------|-------------------|------|
| | 91 | Pulse input display | Pulse Monitor | 0.00 | 0.00–50.00 | kHz |
| | 92 | TI input filter time constant | TI Filter | 10 | 0–9999 | ms |
| | 93 | TI input minimum pulse | TI Pls x1 | 0.00 | 0.00–32.00 | kHz |
| | 94 | Output% at TI minimum pulse | TI Perc y1 | 0.00 | 0.00–100.00 | % |
| | 95 | TI Input maximum pulse | TI Pls x2 | 32.00 | 0.00–32.00 | kHz |
| | 96 | Output% at TI maximum pulse | TI Perc y2 | 100.00 | 0.00–100.00 | % |
| | 97 | Invert TI direction of rotation | TI Inverting | 0 No | 0-1 | - |
| | 98 | TI quantizing level | TI Quantizing | 0.04 | 0.00*, 0.04–10.00 | % |

* Data shaded in grey is applied only for Standard I/O.

*Quantizing is disabled if '0' is selected.

TI Pulse Input Setting Details

| Code | Description |
|--------------------------------------|---|
| In.69 P5 Define | In case of Standard I/O, Pulse input TI and Multi-function terminal P5 share the same terminal. Set the In.69 P5 Define to 54(TI). |
| In.01 Freq at 100% | Configures the frequency reference at the maximum pulse input. The frequency reference is based on 100% of the value set with In.96. <ul style="list-style-type: none"> If In.01 is set to 40.00 and codes In.93–96 are set at default, 32kHz input to TI yields a frequency reference of 40.00Hz. If In.96 is set to 50.00 and codes In.01, In.93–95 are set at default, 32kHz input to the TI terminal yields a frequency reference of 30.00Hz. |
| In.91 Pulse Monitor | Displays the pulse frequency supplied at TI. |
| In.92 TI Filter | Sets the time for the pulse input at TI to reach 63% of its nominal frequency (when the pulse frequency is supplied in multiple steps). |
| In.93 TI Pls x1– In.96 TI Perc y2 | Configures the gradient level and offset values for the output frequency. |

| Code | Description |
|--|---|
| | <p>Frequency reference</p> |
| In.97 TI Inverting– In.98 TI Quantizing | Identical to In.16-17 (refer to In.16 V1 Inverting/In.17.V1 Quantizing on page 69). |

4.1.6 Setting a Frequency Reference via RS-485 Communication

Control the inverter with upper-level controllers, such as PCs or PLCs, via RS-485 communication. Set the Frq (Frequency reference source) code in the Operation group to 6 (Int 485) and use the RS-485 signal input terminals (S+/S-/SG) for communication. Refer to 7 *RS-485 Communication Features* on page 219.

| Group | Code | Name | LCD Display | Parameter Setting | | Setting Range | Unit |
|-----------|------|--|--------------|-------------------|------------|---------------|------|
| Operation | Frq | Frequency reference source | Freq Ref Src | 6 | Int 485 | 0-12 | - |
| In | 01 | Integrated RS-485 communication inverter ID | Int485 St ID | - | 1 | 1-250 | - |
| | 02 | Integrated communication protocol | Int485 Proto | 0 | ModBus RTU | 0-2 | - |
| | | | | 1 | Reserved | | |
| | | | | 2 | LS Inv 485 | | |
| | 03 | Integrated communication speed | Int485 BaudR | 3 | 9600 bps | 0-7 | - |
| | 04 | Integrated communication frame configuration | Int485 Mode | 0 | D8/PN/S1 | 0-3 | - |
| | | | | 1 | D8/PN/S2 | | |
| 2 | | | | D8/PE/S1 | | | |
| 3 | | | | D8/PO/S1 | | | |

4.2 Frequency Hold by Analog Input

If you set a frequency reference via analog input at the control terminal block, you can hold the operation frequency of the inverter by assigning a multi-function input as the analog frequency hold terminal. The operation frequency will be fixed upon an analog input signal.

| group | Code | Name | LCD Display | Parameter Setting | Setting Range | Unit | |
|-----------|-------|----------------------------|----------------------|-------------------|---------------|------|---|
| Operation | Frq | Frequency reference source | Freq Ref Src | 0 | Keypad-1 | 0-12 | - |
| | | | | 1 | Keypad-2 | | |
| | | | | 2 | V1 | | |
| | | | | 4 | V2 | | |
| | | | | 5 | I2 | | |
| | | | | 6 | Int 485 | | |
| | | | | 8 | Field Bus | | |
| | | | | 12 | Pulse | | |
| In | 65-71 | Px terminal configuration | Px Define(Px: P1-P7) | 21 | Analog Hold | 0-54 | - |

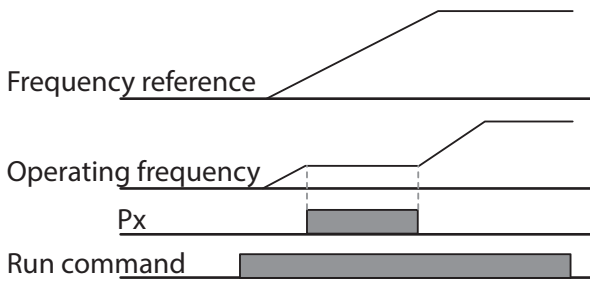

4.3 Changing the Displayed Units (Hz↔Rpm)

You can change the units used to display the operational speed of the inverter by setting Dr. 21 (Speed unit selection) to 0 (Hz) or 1 (Rpm). This function is available only with the LCD keypad.

| Group | Code | Name | LCD Display | Parameter Setting | Setting Range | Unit | |
|-------|------|----------------------|-------------|-------------------|---------------|------|---|
| dr | 21 | Speed unit selection | Hz/Rpm Sel | 0 | Hz Display | 0-1 | - |
| | | | | 1 | Rpm Display | | |

4.4 Setting Multi-step Frequency

Multi-step operations can be carried out by assigning different speeds (or frequencies) to the Px

terminals. Step 0 uses the frequency reference source set with the Frq code in the Operation group. Px terminal parameter values 7 (Speed-L), 8 (Speed-M) and 9 (Speed-H) are recognized as binary commands and work in combination with Fx or Rx run commands. The inverter operates according to the frequencies set with St.1–3 (multi-step frequency 1–3), bA.53–56 (multi-step frequency 4–7) and the binary command combinations.

| Group | Code | Name | LCD Display | Parameter Setting | | Setting Range | Unit |
|-----------|---------|-------------------------------|-----------------------|-------------------|---------|---------------------|------|
| Operation | St1-St3 | Multi-step frequency 1–3 | Step Freq - 1–3 | - | | 0-Maximum frequency | Hz |
| bA | 53–56 | Multi-step frequency 4–7 | Step Freq - 4–7 | - | | 0-Maximum frequency | Hz |
| In | 65–71 | Px terminal configuration | Px Define (Px: P1–P7) | 7 | Speed-L | 0–54 | - |
| | | | | 8 | Speed-M | | - |
| 9 | | | | Speed-H | - | | |
| | 89 | Multi-step command delay time | InCheckTime | 1 | | 1–5000 | ms |

Multi-step Frequency Setting Details

| Code | Description |
|--|---|
| Operation group St 1-St3 Step Freq - 1–3 | Configure multi-step frequency1–3. If an LCD keypad is in use, bA.50–52 is used instead of St1–St3 (multi-step frequency 1-3). |
| bA.53-56 Step Freq - 4-7 | Configure multi-step frequency 4–7. |
| In.65-71 Px Define | Choose the terminals to setup as multi-step inputs, and then set the relevant codes (In.65-71) to 7(Speed-L), 8(Speed-M), or 9(Speed-H). Provided that terminals P3, P4 and P5 have been set to Speed-L, Speed-M and Speed-H respectively, the following multi-step operation will be available. |

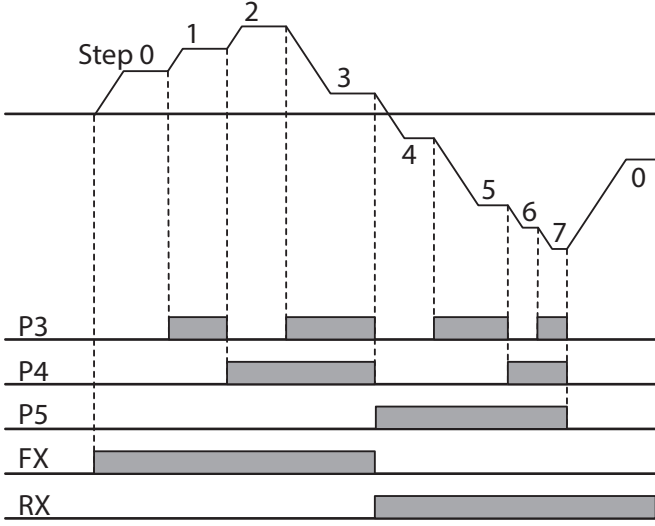
| Code | Description | | | | | | | | | | | | | | | | | | | | | | | | | | | | | | | | | | | | | | | | | | | | | |
|--------------------|---|-------|-------|----|----|----|---|---|---|---|---|---|---|---|---|---|---|---|---|---|---|---|---|---|---|---|---|---|---|---|---|---|---|---|---|---|---|---|---|---|---|---|---|---|---|---|
| |  <p>[An example of a multi-step operation]</p> <table border="1" data-bbox="363 850 1227 1197"> <thead> <tr> <th>Speed</th> <th>Fx/Rx</th> <th>P5</th> <th>P4</th> <th>P3</th> </tr> </thead> <tbody> <tr> <td>0</td> <td>✓</td> <td>-</td> <td>-</td> <td>-</td> </tr> <tr> <td>1</td> <td>✓</td> <td>-</td> <td>-</td> <td>✓</td> </tr> <tr> <td>2</td> <td>✓</td> <td>-</td> <td>✓</td> <td>-</td> </tr> <tr> <td>3</td> <td>✓</td> <td>-</td> <td>✓</td> <td>✓</td> </tr> <tr> <td>4</td> <td>✓</td> <td>✓</td> <td>-</td> <td>-</td> </tr> <tr> <td>5</td> <td>✓</td> <td>✓</td> <td>-</td> <td>✓</td> </tr> <tr> <td>6</td> <td>✓</td> <td>✓</td> <td>✓</td> <td>-</td> </tr> <tr> <td>7</td> <td>✓</td> <td>✓</td> <td>✓</td> <td>✓</td> </tr> </tbody> </table> | Speed | Fx/Rx | P5 | P4 | P3 | 0 | ✓ | - | - | - | 1 | ✓ | - | - | ✓ | 2 | ✓ | - | ✓ | - | 3 | ✓ | - | ✓ | ✓ | 4 | ✓ | ✓ | - | - | 5 | ✓ | ✓ | - | ✓ | 6 | ✓ | ✓ | ✓ | - | 7 | ✓ | ✓ | ✓ | ✓ |
| Speed | Fx/Rx | P5 | P4 | P3 | | | | | | | | | | | | | | | | | | | | | | | | | | | | | | | | | | | | | | | | | | |
| 0 | ✓ | - | - | - | | | | | | | | | | | | | | | | | | | | | | | | | | | | | | | | | | | | | | | | | | |
| 1 | ✓ | - | - | ✓ | | | | | | | | | | | | | | | | | | | | | | | | | | | | | | | | | | | | | | | | | | |
| 2 | ✓ | - | ✓ | - | | | | | | | | | | | | | | | | | | | | | | | | | | | | | | | | | | | | | | | | | | |
| 3 | ✓ | - | ✓ | ✓ | | | | | | | | | | | | | | | | | | | | | | | | | | | | | | | | | | | | | | | | | | |
| 4 | ✓ | ✓ | - | - | | | | | | | | | | | | | | | | | | | | | | | | | | | | | | | | | | | | | | | | | | |
| 5 | ✓ | ✓ | - | ✓ | | | | | | | | | | | | | | | | | | | | | | | | | | | | | | | | | | | | | | | | | | |
| 6 | ✓ | ✓ | ✓ | - | | | | | | | | | | | | | | | | | | | | | | | | | | | | | | | | | | | | | | | | | | |
| 7 | ✓ | ✓ | ✓ | ✓ | | | | | | | | | | | | | | | | | | | | | | | | | | | | | | | | | | | | | | | | | | |
| In.89 InCheck Time | <p>Set a time interval for the inverter to check for additional terminal block inputs after receiving an input signal.</p> <p>After adjusting In.89 to 100ms and an input signal is received at P5, the inverter will search for inputs at other terminals for 100ms, before proceeding to accelerate or decelerate based on P5's configuration.</p> | | | | | | | | | | | | | | | | | | | | | | | | | | | | | | | | | | | | | | | | | | | | | |

4.5 Command Source Configuration

Various devices can be selected as command input devices for the S100 inverter. Input devices available to select include keypad, multi-function input terminal, RS-485 communication and field bus adapter. If UserSeqLink is selected, the common area can be linked with user sequence output and can be used as command.

| Group | Code | Name | LCD Display | Parameter Setting | | Setting Range | Unit |
|-----------|------|----------------|-------------|-------------------|-------------|---------------|------|
| Operation | drv | Command Source | Cmd Source* | 0 | Keypad | 0-5 | - |
| | | | | 1 | Fx/Rx-1 | | |
| | | | | 2 | Fx/Rx-2 | | |
| | | | | 3 | Int 485 | | |
| | | | | 4 | Field Bus | | |
| | | | | 5 | UserSeqLink | | |

* Displayed under DRV-06 on the LCD keypad.

4.5.1 The Keypad as a Command Input Device

The keypad can be selected as a command input device to send command signals to the inverter. This is configured by setting the drv (command source) code to 0 (Keypad). Press the [RUN] key on the keypad to start an operation, and the [STOP/RESET] key to end it.

| group | Code | Name | LCD Display | Parameter Setting | | Setting Range | Unit |
|-----------|------|----------------|-------------|-------------------|--------|---------------|------|
| Operation | drv | Command source | Cmd Source* | 0 | KeyPad | 0-5 | - |

* Displayed under DRV-06 on the LCD keypad.

4.5.2 Terminal Block as a Command Input Device (Fwd/Rev Run Commands)

Multi-function terminals can be selected as a command input device. This is configured by setting the drv (command source) code in the Operation group to 1 (Fx/Rx). Select 2 terminals for the forward and reverse operations, and then set the relevant codes (2 of the 5 multi-function terminal codes, In.65-71 for P1-P7) to 1 (Fx) and 2 (Rx) respectively. This application enables both terminals to be turned on or off at the same time, constituting a stop command that will cause the inverter to stop operation.

| Group | Code | Name | LCD Display | Parameter Setting | | Setting Range | Unit |
|-----------|-------|----------------|-------------------|-------------------|---------|---------------|------|
| Operation | drv | Command source | Cmd Source* | 1 | Fx/Rx-1 | 0-5 | - |
| In | 65-71 | Px terminal | Px Define(Px: P1- | 1 | Fx | 0-54 | - |

| Group | Code | Name | LCD Display | Parameter Setting | Setting Range | Unit |
|-------|------|---------------|-------------|-------------------|---------------|------|
| | | configuration | P7) | 2 Rx | | |

* Displayed under DRV-06 on the LCD keypad.

Fwd/Rev Command by Multi-function Terminal – Setting Details

| Code | Description |
|------------------------------------|--|
| Operation group drv- Cmd Source | Set to 1(Fx/Rx-1). |
| In.65-71 Px Define | Assign a terminal for forward (Fx) operation. Assign a terminal for reverse (Rx) operation. |

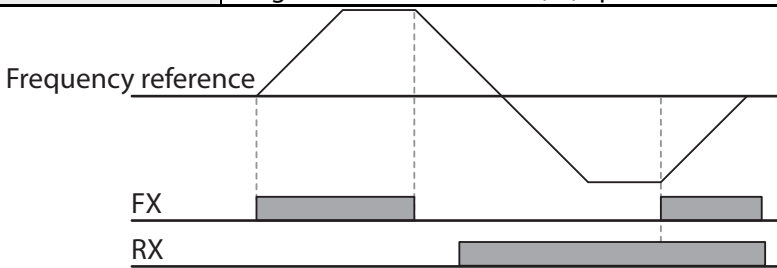

4.5.3 Terminal Block as a Command Input Device (Run and Rotation Direction Commands)

Multi-function terminals can be selected as a command input device. This is configured by setting the drv (command source) code in the Operation group to 2(Fx/Rx-2). Select 2 terminals for run and rotation direction commands, and then select the relevant codes (2 of the 5 multi-function terminal codes, In.65-71 for P1-P7) to 1(Fx) and 2(Rx) respectively. This application uses an Fx input as a run command, and an Rx input to change a motor's rotation direction (On-Rx, Off-Fx).

| Group | Code | Name | LCD Display | Parameter Setting | Setting Range | Unit |
|-----------|-------|---------------------------|-------------------------|-------------------|---------------|------|
| Operation | Drv | Command source | Cmd Source* | 2 Fx/Rx-2 | 0-5 | - |
| In | 65-71 | Px terminal configuration | Px Define (Px: P1 - P7) | 1 Fx | 0-54 | - |
| | | | | 2 Rx | | |

* Displayed under DRV-06 on the LCD keypad.

Run Command and Fwd/Rev Change Command Using Multi-function Terminal – Setting Details

| Code | Description |
|-----------------------------------|--------------------|
| Operation group drv Cmd Source | Set to 2(Fx/Rx-2). |

| Code | Description |
|--------------------|--|
| In.65–71 Px Define | Assign a terminal for run command (Fx). Assign a terminal for changing rotation direction (Rx). |

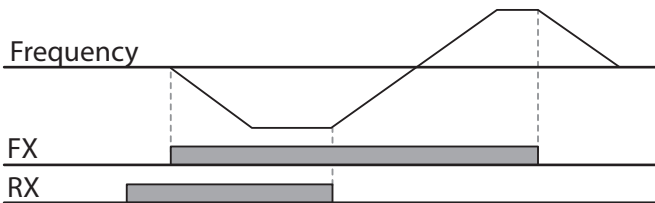

4.5.4 RS-485 Communication as a Command Input Device

Internal RS-485 communication can be selected as a command input device by setting the drv (command source) code in the Operation group to 3(Int 485). This configuration uses upper level controllers such as PCs or PLCs to control the inverter by transmitting and receiving signals via the S+, S-, and Sg terminals at the terminal block. For more details, refer to [7 RS-485 Communication Features](#) on page 219.

| Group | Code | Name | LCD Display | Parameter Setting | Setting Range | Unit |
|-----------|------|--------------------------------------|--------------|-------------------|---------------|------|
| Operation | drv | Command source | Cmd Source* | 3 Int 485 | 0-5 | - |
| CM | 01 | Integrated communication inverter ID | Int485 St ID | 1 | 1-250 | - |
| | 02 | Integrated communication protocol | Int485 Proto | 0 ModBus RTU | 0-2 | - |
| | 03 | Integrated communication speed | Int485 BaudR | 3 9600 bps | 0-7 | - |
| | 04 | Integrated communication frame setup | Int485 Mode | 0 D8 / PN / S1 | 0-3 | - |

* Displayed under DRV-06 on the LCD keypad.

4.6 Local/Remote Mode Switching

Local/remote switching is useful for checking the operation of an inverter or to perform an inspection while retaining all parameter values. Also, in an emergency, it can also be used to override control and operate the system manually using the keypad.

The [ESC] key is a programmable key that can be configured to carry out multiple functions. For

more details, refer to [3.2.4 Configuring the \[ESC\] Key](#) on page 50.

| Group | Code | Name | LCD Display | Parameter Setting | | Setting Range | Unit |
|-----------|------|---------------------|-------------|-------------------|--------------|---------------|------|
| dr | 90 | [ESC] key functions | - | 2 | Local/Remote | 0-2 | - |
| Operation | drv | Command source | Cmd Source* | 1 | Fx/Rx-1 | 0-5 | - |

* Displayed under DRV-06 on the LCD keypad.

Local/Remote Mode Switching Setting Details

| Code | Description |
|------------------------------|---|
| dr.90 [ESC] key functions | Set dr.90 to 2(Local/Remote) to perform local/remote switching using the [ESC] key. Once the value is set, the inverter will automatically begin operating in remote mode. Changing from local to remote will not alter any previously configured parameter values and the operation of the inverter will not change. Press the [ESC] key to switch the operation mode back to "local." The SET light will flash, and the inverter will operate using the [RUN] key on the keypad. Press the [ESC] key again to switch the operation mode back to "remote." The SET light will turn off and the inverter will operate according to the previous drv code configuration. |

Note

Local/Remote Operation

- Full control of the inverter is available with the keypad during local operation (local operation).
- During local operation, jog commands will only work if one of the P1-P7 multi-function terminals (codes In.65-71) is set to 13(RUN Enable) and the relevant terminal is turned on.
- During remote operation (remote operation), the inverter will operate according to the previously set frequency reference source and the command received from the input device.
- If Ad.10 (power-on run) is set to 0(No), the inverter will NOT operate on power-on even when the following terminals are turned on:
 - Fwd/Rev run (Fx/Rx) terminal
 - Fwd/Rev jog terminal (Fwd jog/Rev Jog)
 - Pre-Excitation terminal

To operate the inverter manually with the keypad, switch to local mode. Use caution when switching back to remote operation mode as the inverter will stop operating. If Ad.10 (power-on run) is set to 0(No), a command through the input terminals will work ONLY AFTER all the terminals listed above have been turned off and then turned on again.

- If the inverter has been reset to clear a fault trip during an operation, the inverter will switch to local operation mode at power-on, and full control of the inverter will be with the keypad. The inverter will stop operating when operation mode is switched from "local" to "remote". In this case, a run command through an input terminal will work ONLY AFTER all the input terminals have been turned off.

Inverter Operation During Local/Remote Switching

Switching operation mode from “remote” to “local” while the inverter is running will cause the inverter to stop operating. Switching operation mode from “local” to “remote” however, will cause the inverter to operate based on the command source:

- Analog commands via terminal input: the inverter will continue to run without interruption based on the command at the terminal block. If a reverse operation (Rx) signal is ON at the terminal block at startup, the inverter will operate in the reverse direction even if it was running in the forward direction in local operation mode before the reset.
- Digital source commands: all command sources except terminal block command sources (which are analog sources) are digital command sources that include the keypad, LCD keypad, and communication sources. The inverter stops operation when switching to remote operation mode, and then starts operation when the next command is given.

⚠ Caution

Use local/remote operation mode switching only when it is necessary. Improper mode switching may result in interruption of the inverter’s operation.

4.7 Forward or Reverse Run Prevention

The rotation direction of motors can be configured to prevent motors to only run in one direction. Pressing the [REV] key on the LCD keypad when direction prevention is configured, will cause the motor to decelerate to 0Hz and stop. The inverter will remain on.

| Group | Code | Name | LCD Display | Parameter Setting | | Setting Range | Unit |
|-------|------|------------------------|-------------|-------------------|--------------|---------------|------|
| Ad | 09 | Run prevention options | Run Prevent | 0 | None | 0–2 | - |
| | | | | 1 | Forward Prev | | |
| | | | | 2 | Reverse Prev | | |

Forward/Reverse Run Prevention Setting Details

| Code | Description | | |
|-------------------|--------------------------------|-----------------------------|-----------------------------|
| Ad.09 Run Prevent | Choose a direction to prevent. | | |
| | Setting | | Description |
| | 0 | None | Do not set run prevention. |
| | 1 | Forward Prev | Set forward run prevention. |
| 2 | Reverse Prev | Set reverse run prevention. | |

4.8 Power-on Run

A power-on command can be setup to start an inverter operation after powering up, based on terminal block operation commands (if they have been configured). To enable power-on run set the drv (command source) code to 1 (Fx/Rx-1) or 2 (Fx/Rx-2) in the Operation group.

| Group | Code | Name | LCD Display | Parameter Setting | Setting Range | Unit |
|-----------|------|----------------|--------------|-------------------|-----------------------|------|
| Operation | drv | Command source | Cmd Source* | 1, 2 | Fx/Rx-1 or Fx/Rx-2 | 0-5 |
| Ad | 10 | Power-on run | Power-on Run | 1 | Yes | 0-1 |

* Displayed under DRV-06 on the LCD keypad.

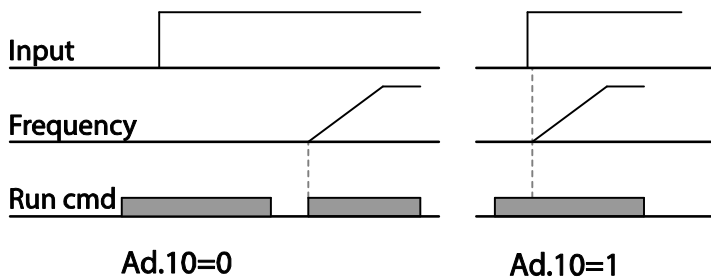

Note

- A fault trip may be triggered if the inverter starts operation while a motor's load (fan-type load) is in free-run state. To prevent this from happening, set bit4 to 1 in Cn. 71 (speed search options) of the Control group. The inverter will perform a speed search at the beginning of the operation.
- If the speed search is not enabled, the inverter will begin its operation in a normal V/F pattern and accelerate the motor. If the inverter has been turned on without power-on run enabled, the terminal block command must first be turned off, and then turned on again to begin the inverter's operation.

⚠ Caution

Use caution when operating the inverter with Power-on Run enabled as the motor will begin rotating when the inverter starts up.

4.9 Reset and Restart

Reset and restart operations can be setup for inverter operation following a fault trip, based on the terminal block operation command (if it is configured). When a fault trip occurs, the inverter cuts off the output and the motor will free-run. Another fault trip may be triggered if the inverter

begins its operation while motor load is in a free-run state.

| Group | Code | Name | LCD Display | Parameter Setting | Setting Range | Unit |
|-----------|------|-------------------------|--------------|-------------------|---------------|------|
| Operation | drv | Command source | Cmd Source* | 1 | Fx/Rx-1 or | 0-5 |
| | | | | 2 | Fx/Rx-2 | |
| Pr | 08 | Reset restart setup | RST Restart | 1 | Yes | 0-1 |
| | 09 | No. of auto restart | Retry Number | 0 | | 0-10 |
| | 10 | Auto restart delay time | Retry Delay | 1.0 | | 0-60 |

* Displayed under DRV-06 in an LCD keypad.

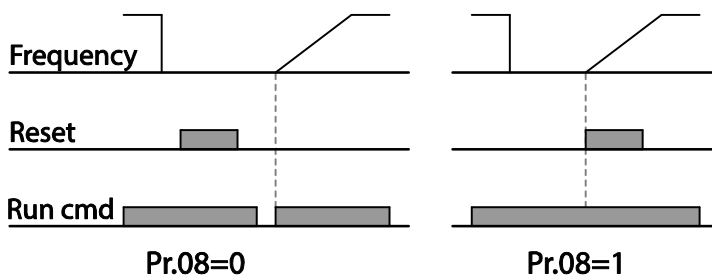

Note

- To prevent a repeat fault trip from occurring, set Cn.71 (speed search options) bit 2 equal to 1. The inverter will perform a speed search at the beginning of the operation.
- If the speed search is not enabled, the inverter will start its operation in a normal V/F pattern and accelerate the motor. If the inverter has been turned on without 'reset and restart' enabled, the terminal block command must be first turned off, and then turned on again to begin the inverter's operation.

⚠ Caution

Use caution when operating the inverter with Power-on Run enabled as the motor will begin rotating when the inverter starts up.

4.10 Setting Acceleration and Deceleration Times

4.10.1 Acc/Dec Time Based on Maximum Frequency

Acc/Dec time values can be set based on maximum frequency, not on inverter operation frequency. To set Acc/Dec time values based on maximum frequency, set bA. 08 (Acc/Dec reference) in the Basic group to 0 (Max Freq).

Acceleration time set at the ACC (Acceleration time) code in the Operation group (dr.03 in an LCD keypad) refers to the time required for the inverter to reach the maximum frequency from a stopped (0Hz) state. Likewise, the value set at the dEC (deceleration time) code in the Operation group (dr.04 in an LCD keypad) refers to the time required to return to a stopped state (0Hz) from the maximum frequency.

| Group | Code | Name | LCD Display | Parameter Setting | | Setting Range | Unit |
|-----------|------|-----------------------------|-------------|-------------------|----------|---------------|------|
| Operation | ACC | Acceleration time | Acc Time | 20.0 | | 0.0–600.0 | sec |
| | dEC | Deceleration time | Dec Time | 30.0 | | 0.0–600.0 | sec |
| | 20 | Maximum frequency | Max Freq | 60.00 | | 40.00–400.00 | Hz |
| bA | 08 | Acc/Dec reference frequency | Ramp T Mode | 0 | Max Freq | 0–1 | - |
| | 09 | Time scale | Time scale | 1 | 0.1sec | 0–2 | - |

Acc/Dec Time Based on Maximum Frequency – Setting Details

| Code | Description | | | | | | |
|---|--|---------------|-------------|-----------------|--|-------------------|--|
| bA.08 Ramp T Mode | Set the parameter value to 0 (Max Freq) to setup Acc/Dec time based on maximum frequency. | | | | | | |
| | <table border="1"> <thead> <tr> <th>Configuration</th> <th>Description</th> </tr> </thead> <tbody> <tr> <td>0 Max Freq</td> <td>Set the Acc/Dec time based on maximum frequency.</td> </tr> <tr> <td>1 Delta Freq</td> <td>Set the Acc/Dec time based on operating frequency.</td> </tr> </tbody> </table> | Configuration | Description | 0 Max Freq | Set the Acc/Dec time based on maximum frequency. | 1 Delta Freq | Set the Acc/Dec time based on operating frequency. |
| | Configuration | Description | | | | | |
| 0 Max Freq | Set the Acc/Dec time based on maximum frequency. | | | | | | |
| 1 Delta Freq | Set the Acc/Dec time based on operating frequency. | | | | | | |
| If, for example, maximum frequency is 60.00Hz, the Acc/Dec times are set to 5 seconds, and the frequency reference for operation is set at 30Hz (half of 60Hz), the time required to reach 30Hz therefore is 2.5 seconds (half of 5 seconds). | | | | | | | |

| Code | Description | | | | | | | | |
|------------------|--|---------------|-------------|---|--|---|--|---|--|
| | | | | | | | | | |
| bA.09 Time scale | <p>Use the time scale for all time-related values. It is particularly useful when a more accurate Acc/Dec times are required because of load characteristics, or when the maximum time range needs to be extended.</p> <table border="1"> <thead> <tr> <th>Configuration</th> <th>Description</th> </tr> </thead> <tbody> <tr> <td>0</td> <td>0.01sec Sets 0.01 second as the minimum unit.</td> </tr> <tr> <td>1</td> <td>0.1sec Sets 0.1 second as the minimum unit.</td> </tr> <tr> <td>2</td> <td>1sec Sets 1 second as the minimum unit.</td> </tr> </tbody> </table> | Configuration | Description | 0 | 0.01sec Sets 0.01 second as the minimum unit. | 1 | 0.1sec Sets 0.1 second as the minimum unit. | 2 | 1sec Sets 1 second as the minimum unit. |
| Configuration | Description | | | | | | | | |
| 0 | 0.01sec Sets 0.01 second as the minimum unit. | | | | | | | | |
| 1 | 0.1sec Sets 0.1 second as the minimum unit. | | | | | | | | |
| 2 | 1sec Sets 1 second as the minimum unit. | | | | | | | | |

⚠ Caution

Note that the range of maximum time values may change automatically when the units are changed. If for example, the acceleration time is set at 6000 seconds, a time scale change from 1 second to 0.01 second will result in a modified acceleration time of 60.00 seconds.

4.10.2 Acc/Dec Time Based on Operation Frequency

Acc/Dec times can be set based on the time required to reach the next step frequency from the existing operation frequency. To set the Acc/Dec time values based on the existing operation frequency, set bA. 08 (acc/dec reference) in the Basic group to 1 (Delta Freq).

| Group | Code | Name | LCD Display | Parameter Setting | Setting Range | Unit |
|-----------|------|-------------------|-------------|-------------------|---------------|------|
| Operation | ACC | Acceleration time | Acc Time | 20.0 | 0.0-600.0 | sec |
| | dEC | Deceleration time | Dec Time | 30.0 | 0.0-600.0 | sec |
| bA | 08 | Acc/Dec reference | Ramp T Mode | 1 Delta Freq | 0-1 | - |

Acc/Dec Time Based on Operation Frequency – Setting Details

| Code | Description | | | | | | |
|---|--|---------------|-------------|---|--|---|--|
| bA.08 Ramp T Mode | Set the parameter value to 1 (Delta Freq) to set Acc/Dec times based on Maximum frequency. | | | | | | |
| | <table border="1"> <thead> <tr> <th>Configuration</th> <th>Description</th> </tr> </thead> <tbody> <tr> <td>0</td> <td>Max Freq Set the Acc/Dec time based on Maximum frequency.</td> </tr> <tr> <td>1</td> <td>Delta Freq Set the Acc/Dec time based on Operation frequency.</td> </tr> </tbody> </table> | Configuration | Description | 0 | Max Freq Set the Acc/Dec time based on Maximum frequency. | 1 | Delta Freq Set the Acc/Dec time based on Operation frequency. |
| | Configuration | Description | | | | | |
| 0 | Max Freq Set the Acc/Dec time based on Maximum frequency. | | | | | | |
| 1 | Delta Freq Set the Acc/Dec time based on Operation frequency. | | | | | | |
| If Acc/Dec times are set to 5 seconds, and multiple frequency references are used in the operation in 2 steps, at 10Hz and 30 Hz, each acceleration stage will take 5 seconds (refer to the graph below). | | | | | | | |

Frequency

4.10.3 Multi-step Acc/Dec Time Configuration

Acc/Dec times can be configured via a multi-function terminal by setting the ACC (acceleration time) and dEC (deceleration time) codes in the Operation group.

| Group | Code | Name | LCD Display | Parameter Setting | Setting Range | Unit | |
|-----------|-------|---------------------------------|-----------------------|-------------------|---------------|------|---|
| Operation | ACC | Acceleration time | Acc Time | 20.0 | 0.0–600.0 | sec | |
| | dEC | Deceleration time | Dec Time | 30.0 | 0.0–600.0 | sec | |
| bA | 70-82 | Multi-step acceleration time1-7 | Acc Time 1-7 | x.xx | 0.0–600.0 | sec | |
| | 71-83 | Multi-step deceleration time1-7 | Dec Time 1-7 | x.xx | 0.0–600.0 | sec | |
| In | 65-71 | Px terminal configuration | Px Define (Px: P1–P7) | 11 | XCEL-L | 0–54 | - |
| | | | | 12 | XCEL-M | | |
| | | | | 49 | XCEL-H | | |
| | 89 | Multi-step command delay time | In Check Time | 1 | 1–5000 | ms | |

Acc/Dec Time Setup via Multi-function Terminals – Setting Details

| Code | Description | | | | | | | | | | | | | | | | | | | | | | | | | | |
|-------------------------------|---|-------------------|--|-------------|----|--------|-------------------|----|--------|-------------------|----|--------|-------------------|--------------|----|----|---|---|---|---|---|---|---|---|---|---|---|
| bA.70–82 AccTime 1–7 | Set multi-step acceleration time1-7. | | | | | | | | | | | | | | | | | | | | | | | | | | |
| bA.71–83 DecTime 1–7 | Set multi-step deceleration time1-7. | | | | | | | | | | | | | | | | | | | | | | | | | | |
| In.65–71 Px Define (P1–P7) | Choose and configure the terminals to use for multi-step Acc/Dec time inputs. | | | | | | | | | | | | | | | | | | | | | | | | | | |
| | <table border="1"> <thead> <tr> <th colspan="2">Configuration</th> <th>Description</th> </tr> </thead> <tbody> <tr> <td>11</td> <td>XCEL-L</td> <td>Acc/Dec command-L</td> </tr> <tr> <td>12</td> <td>XCEL-M</td> <td>Acc/Dec command-M</td> </tr> <tr> <td>49</td> <td>XCEL-H</td> <td>Acc/Dec command-H</td> </tr> </tbody> </table> <p>Acc/Dec commands are recognized as binary code inputs and will control the acceleration and deceleration based on parameter values set with bA.70-82 and bA.71-83.</p> <p>If, for example, the P4 and P5 terminals are set as XCEL-L and XCEL respectively, the following operation will be available.</p> <table border="1"> <thead> <tr> <th>Acc/Dec time</th> <th>P5</th> <th>P4</th> </tr> </thead> <tbody> <tr> <td>0</td> <td>-</td> <td>-</td> </tr> <tr> <td>1</td> <td>-</td> <td>✓</td> </tr> <tr> <td>2</td> <td>✓</td> <td>-</td> </tr> <tr> <td>3</td> <td>✓</td> <td>✓</td> </tr> </tbody> </table> | Configuration | | Description | 11 | XCEL-L | Acc/Dec command-L | 12 | XCEL-M | Acc/Dec command-M | 49 | XCEL-H | Acc/Dec command-H | Acc/Dec time | P5 | P4 | 0 | - | - | 1 | - | ✓ | 2 | ✓ | - | 3 | ✓ |
| Configuration | | Description | | | | | | | | | | | | | | | | | | | | | | | | | |
| 11 | XCEL-L | Acc/Dec command-L | | | | | | | | | | | | | | | | | | | | | | | | | |
| 12 | XCEL-M | Acc/Dec command-M | | | | | | | | | | | | | | | | | | | | | | | | | |
| 49 | XCEL-H | Acc/Dec command-H | | | | | | | | | | | | | | | | | | | | | | | | | |
| Acc/Dec time | P5 | P4 | | | | | | | | | | | | | | | | | | | | | | | | | |
| 0 | - | - | | | | | | | | | | | | | | | | | | | | | | | | | |
| 1 | - | ✓ | | | | | | | | | | | | | | | | | | | | | | | | | |
| 2 | ✓ | - | | | | | | | | | | | | | | | | | | | | | | | | | |
| 3 | ✓ | ✓ | | | | | | | | | | | | | | | | | | | | | | | | | |
| In.89 In Check Time | Set the time for the inverter to check for other terminal block inputs. If In.89 is set to 100ms and a signal is supplied to the P4 terminal, the inverter searches for other inputs over the next 100ms. When the time expires, the Acc/Dec time will be set based on the input received at P4. | | | | | | | | | | | | | | | | | | | | | | | | | | |

4.10.4 Configuring Acc/Dec Time Switch Frequency

You can switch between two different sets of Acc/Dec times (Acc/Dec gradients) by configuring the switch frequency without configuring the multi-function terminals.

| Group | Code | Name | LCD Display | Parameter Setting | Setting Range | Unit |
|-----------|------|-------------------------------|-----------------|-------------------|---------------------|------|
| Operation | ACC | Acceleration time | Acc Time | 10.0 | 0.0–600.0 | sec |
| | dEC | Deceleration time | Dec Time | 10.0 | 0.0–600.0 | sec |
| bA | 70 | Multi-step acceleration time1 | Acc Time-1 | 20.0 | 0.0–600.0 | sec |
| | 71 | Multi-step deceleration time1 | Dec Time-1 | 20.0 | 0.0–600.0 | sec |
| Ad | 60 | Acc/Dec time switch frequency | Xcel Change Frq | 30.00 | 0–Maximum frequency | Hz |

Acc/Dec Time Switch Frequency Setting Details

| Code | Description |
|-------------------------|---|
| Ad.60 Xcel Change Fr | After the Acc/Dec switch frequency has been set, Acc/Dec gradients configured at bA.70 and 71 will be used when the inverter’s operation frequency is at or below the switch frequency. If the operation frequency exceeds the switch frequency, the configured gradient level, configured for the ACC and dEC codes, will be used. If you configure the P1-P7 multi-function input terminals for multi-step Acc/Dec gradients (XCEL-L, XCEL-M, XCEL-H), the inverter will operate based on the Acc/Dec inputs at the terminals instead of the Acc/Dec switch frequency configurations. |

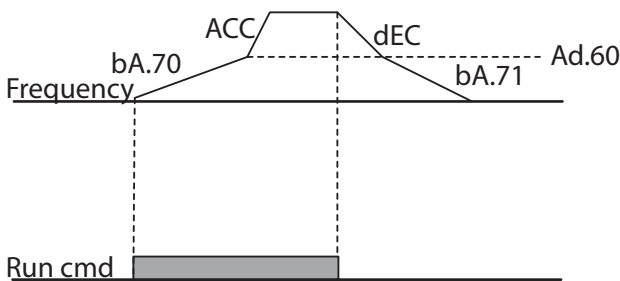

4.11 Acc/Dec Pattern Configuration

Acc/Dec gradient level patterns can be configured to enhance and smooth the inverter’s acceleration and deceleration curves. Linear pattern features a linear increase or decrease to the output frequency, at a fixed rate. For an S-curve pattern a smoother and more gradual increase

or decrease of output frequency, ideal for lift-type loads or elevator doors, etc. S-curve gradient level can be adjusted using codes Ad. 03-06 in the Advanced group.

| Group | Code | Name | LCD Display | Parameter Setting | | Setting Range | Unit |
|-------|------|----------------------------|-------------|-------------------|----------|---------------|------|
| bA | 08 | Acc/Dec reference | Ramp T mode | 0 | Max Freq | 0-1 | - |
| Ad | 01 | Acceleration pattern | Acc Pattern | 0 | Linear | 0-1 | - |
| | 02 | Deceleration pattern | Dec Pattern | 1 | S-curve | | - |
| | 03 | S-curve Acc start gradient | Acc S Start | 40 | | 1-100 | % |
| | 04 | S-curve Acc end gradient | Acc S End | 40 | | 1-100 | % |
| | 05 | S-curve Dec start gradient | Dec S Start | 40 | | 1-100 | % |
| | 06 | S-curve Dec end gradient | Dec S End | 40 | | 1-100 | % |

Acc/Dec Pattern Setting Details

| Code | Description |
|--|--|
| Ad.03 Acc S Start | <p>Sets the gradient level as acceleration starts when using an S-curve, Acc/Dec pattern. Ad. 03 defines S-curve gradient level as a percentage, up to half of total acceleration.</p> <p>If the frequency reference and maximum frequency are set at 60Hz and Ad.03 is set to 50%, Ad. 03 configures acceleration up to 30Hz (half of 60Hz).The inverter will operate S-curve acceleration in the 0-15Hz frequency range (50% of 30Hz). Linear acceleration will be applied to the remaining acceleration within the 15-30Hz frequency range.</p> |
| Ad.04 Acc S End | <p>Sets the gradient level as acceleration ends when using an S-curve Acc/Dec pattern. Ad. 03 defines S-curve gradient level as a percentage, above half of total acceleration.</p> <p>If the frequency reference and the maximum frequency are set at 60Hz and Ad.04 is set to 50%, setting Ad. 04 configures acceleration to increase from 30Hz (half of 60Hz) to 60Hz (end of acceleration). Linear acceleration will be applied within the 30-45Hz frequency range. The inverter will perform an S-curve acceleration for the remaining acceleration in the 45-60Hz frequency range.</p> |
| Ad.05 Dec S Start – Ad.06 Dec S End | <p>Sets the rate of S-curve deceleration. Configuration for codes Ad.05 and Ad.06 may be performed the same way as configuring codes Ad.03 and Ad.04.</p> |

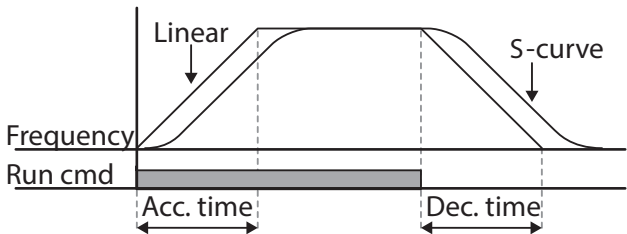

[Acceleration / deceleration pattern configuration]

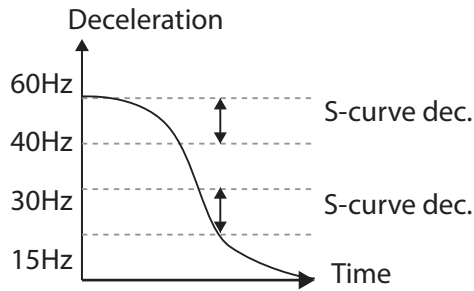
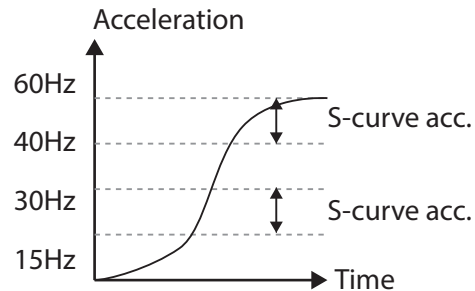
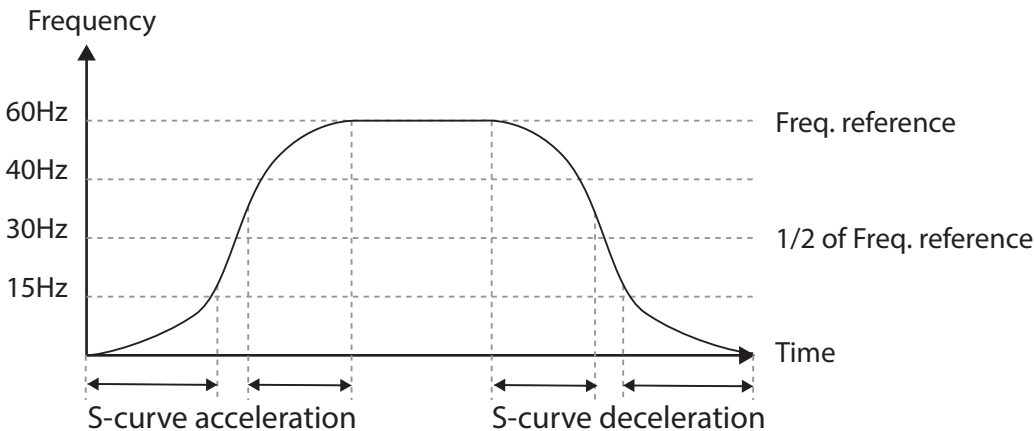

[Acceleration / deceleration S-curve parthen configuration]

Note

The Actual Acc/Dec time during an S-curve application

Actual acceleration time = user-configured acceleration time + user-configured acceleration time x starting gradient level/2 + user-configured acceleration time x ending gradient level/2.

Actual deceleration time = user-configured deceleration time + user-configured deceleration time x starting gradient level/2 + user-configured deceleration time x ending gradient level/2.

⚠ Caution

Note that actual Acc/Dec times become greater than user defined Acc/Dec times when S-curve Acc/Dec patterns are in use.

4.12 Stopping the Acc/Dec Operation

Configure the multi-function input terminals to stop acceleration or deceleration and operate the inverter at a fixed frequency.

| Group | Code | Name | LCD Display | Parameter Setting | | Setting Range | Unit |
|-------|-------|---------------------------|----------------------|-------------------|-----------|---------------|------|
| In | 65-71 | Px terminal configuration | Px Define(Px: P1-P7) | 25 | XCEL Stop | 0-54 | - |

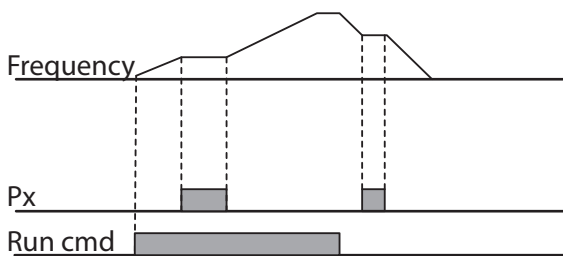

4.13 V/F(Voltage/Frequency) Control

Configure the inverter's output voltages, gradient levels and output patterns to achieve a target output frequency with V/F control. The amount of torque boost used during low frequency operations can also be adjusted.

4.13.1 Linear V/F Pattern Operation

A linear V/F pattern configures the inverter to increase or decrease the output voltage at a fixed rate for different operation frequencies based on V/F characteristics. A linear V/F pattern is particularly useful when a constant torque load is applied.

| Group | Code | Name | LCD Display | Parameter Setting | | Setting Range | Unit |
|-------|------|----------------|--------------|-------------------|-----|---------------|------|
| dr | 09 | Control mode | Control Mode | 0 | V/F | 0-4 | - |
| | 18 | Base frequency | Base Freq | 60.00 | | 30.00-400.00 | Hz |

| Group | Code | Name | LCD Display | Parameter Setting | Setting Range | Unit |
|-------|------|-----------------|-------------|-------------------|---------------|------|
| | 19 | Start frequency | Start Freq | 0.50 | 0.01–10.00 | Hz |
| bA | 07 | V/F pattern | V/F Pattern | 0 Linear | 0–3 | - |

Linear V/F Pattern Setting Details

| Code | Description |
|------------------|---|
| dr.18 Base Freq | Sets the base frequency. A base frequency is the inverter’s output frequency when running at its rated voltage. Refer to the motor’s rating plate to set this parameter value. |
| dr.19 Start Freq | <p>Sets the start frequency. A start frequency is a frequency at which the inverter starts voltage output. The inverter does not produce output voltage while the frequency reference is lower than the set frequency. However, if a deceleration stop is made while operating above the start frequency, output voltage will continue until the operation frequency reaches a full-stop (0Hz).</p> |

4.13.2 Square Reduction V/F pattern Operation

Square reduction V/F pattern is ideal for loads such as fans and pumps. It provides non-linear acceleration and deceleration patterns to sustain torque throughout the whole frequency range.

| Group | Code | Name | LCD Display | Parameter Setting | Setting Range | Unit |
|-------|------|-------------|-------------|---------------------------|---------------|------|
| bA | 07 | V/F pattern | V/F Pattern | 1 Square 3 Square2 | 0–3 | - |

Square Reduction V/F pattern Operation - Setting Details

| Code | Description | | | | | | |
|-------------------|--|---------|----------|---|--------|---|---------|
| bA.07 V/F Pattern | <p>Sets the parameter value to 1(Square) or 3(Square2) according to the load’s start characteristics.</p> <table border="1"> <thead> <tr> <th>Setting</th> <th>Function</th> </tr> </thead> <tbody> <tr> <td>1</td> <td>Square</td> </tr> <tr> <td>3</td> <td>Square2</td> </tr> </tbody> </table> <p>The inverter produces output voltage proportional to 1.5</p> | Setting | Function | 1 | Square | 3 | Square2 |
| Setting | Function | | | | | | |
| 1 | Square | | | | | | |
| 3 | Square2 | | | | | | |

| Code | Description | | |
|------|-------------|---------|--|
| | | | square of the operation frequency. |
| | 3 | Square2 | The inverter produces output voltage proportional to 2 square of the operation frequency. This setup is ideal for variable torque loads such as fans or pumps. |

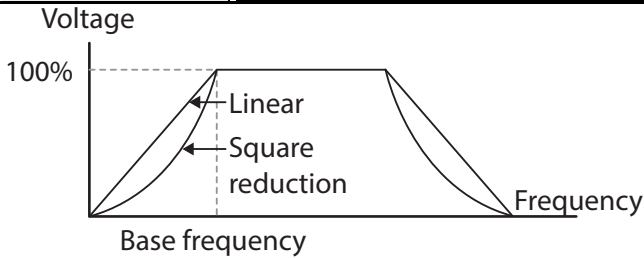

4.13.3 User V/F Pattern Operation

The S100 inverter allows the configuration of user-defined V/F patterns to suit the load characteristics of special motors.

| Group | Code | Name | LCD Display | Parameter Setting | Setting Range | Unit | |
|-------|------|-----------------|-------------|-------------------|---------------|---------------------|----|
| bA | 07 | V/F pattern | V/F Pattern | 2 | User V/F | 0-3 | - |
| | 41 | User Frequency1 | User Freq 1 | 15.00 | | 0-Maximum frequency | Hz |
| | 42 | User Voltage1 | User Volt 1 | 25 | | 0-100 | % |
| | 43 | User Frequency2 | User Freq 2 | 30.00 | | 0-Maximum frequency | Hz |
| | 44 | User Voltage2 | User Volt 2 | 50 | | 0-100 | % |
| | 45 | User Frequency3 | User Freq 3 | 45.00 | | 0-Maximum frequency | Hz |
| | 46 | User Voltage3 | User Volt 3 | 75 | | 0-100 | % |
| | 47 | User Frequency4 | User Freq 4 | Maximum frequency | | 0-Maximum frequency | Hz |
| | 48 | User Voltage4 | User Volt 4 | 100 | | 0-100% | % |

User V/F pattern Setting Details

| Code | Description |
|---|--|
| bA.41 User Freq 1– bA.48 User Volt 4 | Set the parameter values to assign arbitrary frequencies (User Freq 1–4) for start and maximum frequencies. Voltages can also be set to correspond with each frequency, and for each user voltage (User Volt 1–4). |

The 100% output voltage in the figure below is based on the parameter settings of bA.15 (motor rated voltage). If bA.15 is set to 0 it will be based on the input voltage.

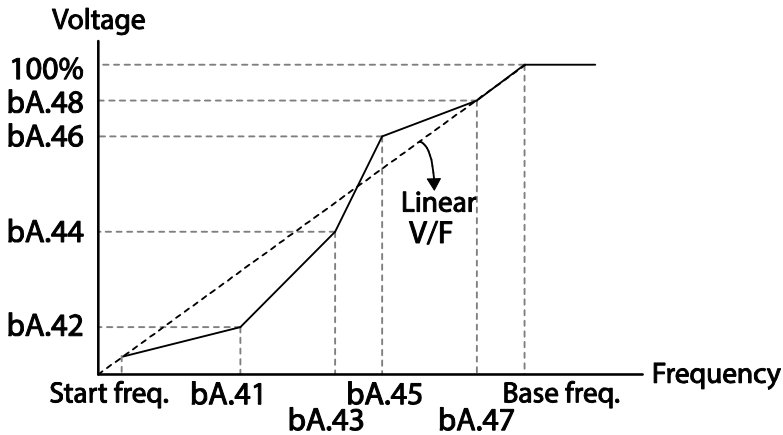

⚠ Caution

- When a normal induction motor is in use, care must be taken not to configure the output pattern away from a linear V/F pattern. Non-linear V/F patterns may cause insufficient motor torque or motor overheating due to over-excitation.
- When a user V/F pattern is in use, forward torque boost (dr.16) and reverse torque boost (dr.17) do not operate.

4.14 Torque Boost

4.14.1 Manual Torque Boost

Manual torque boost enables users to adjust output voltage during low speed operation or motor start. Increase low speed torque or improve motor starting properties by manually increasing output voltage. Configure manual torque boost while running loads that require high starting torque, such as lift-type loads.

| Group | Code | Name | LCD Display | Parameter Setting | Setting Range | Unit |
|-------|------|----------------------|--------------|-------------------|---------------|------|
| Dr | 15 | Torque boost options | Torque Boost | 0 Manual | 0–1 | - |
| | 16 | Forward torque boost | Fwd Boost | 2.0 | 0.0–15.0 | % |
| | 17 | Reverse torque boost | Rev Boost | 2.0 | 0.0–15.0 | % |

Manual Torque Boost Setting Details

| Code | Description |
|-----------------|---|
| dr.16 Fwd Boost | Set torque boost for forward operation. |
| dr.17 Rev Boost | Set torque boost for reverse operation. |

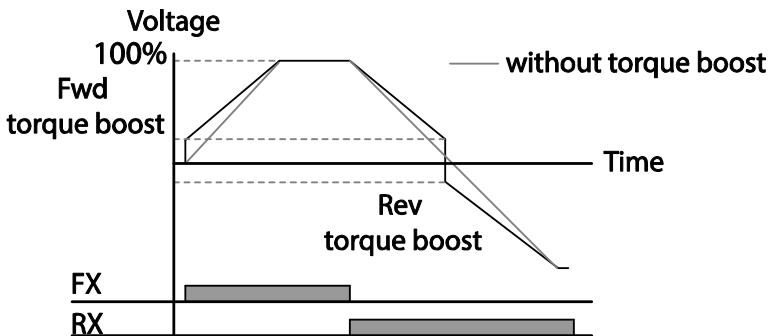

⚠ Caution

Excessive torque boost will result in over-excitation and motor overheating .

4.14.2 Auto Torque Boost-1

Auto torque boost enables the inverter to automatically calculate the amount of output voltage required for torque boost based on the entered motor parameters. Because auto torque boost requires motor-related parameters such as stator resistance, inductance, and no-load current, auto tuning (bA.20) has to be performed before auto torque boost can be configured [Refer to [5.9 Auto Tuning](#) on page 144]. Similarly to manual torque boost, configure auto torque boost while running a load that requires high starting torque, such as lift-type loads.

| Group | Code | Name | LCD Display | Parameter Setting | Setting Range | Unit |
|-------|------|-------------------|--------------|-------------------|---------------|------|
| Dr | 15 | torque boost mode | Torque Boost | 1 Auto1 | 0-2 | - |
| bA | 20 | auto tuning | Auto Tuning | 3 Rs+Lsigma | 0-6 | - |

4.14.3 Auto Torque Boost-2

In V/F operation, this adjusts the output voltage if operation is unavailable due to a low output voltage. It is used when operation is unavailable, due to a lack of starting torque, by providing a voltage boost to the output voltage via the torque current.

| Group | Code | Name | LCD Display | Parameter Setting | Setting Range | Unit |
|-------|------|-------------------|--------------|-------------------|---------------|------|
| Dr | 15 | torque boost mode | Torque Boost | 2 Auto2 | 0-2 | - |

4.15 Output Voltage Setting

Output voltage settings are required when a motor's rated voltage differs from the input voltage to the inverter. Set bA.15 to configure the motor's rated operating voltage. The set voltage becomes the output voltage of the inverter's base frequency. When the inverter operates above the base frequency, and when the motor's voltage rating is lower than the input voltage at the inverter, the inverter adjusts the voltage and supplies the motor with the voltage set at bA.15 (motor rated voltage). If the motor's rated voltage is higher than the input voltage at the inverter, the inverter will supply the inverter input voltage to the motor.

If bA.15 (motor rated voltage) is set to 0, the inverter corrects the output voltage based on the input voltage in the stopped condition. If the frequency is higher than the base frequency, when the input voltage is lower than the parameter setting, the input voltage will be the inverter output voltage.

| Group | Code | Name | LCD Display | Parameter Setting | Setting Range | Unit |
|-------|------|---------------------|-------------|-------------------|---------------|------|
| bA | 15 | Motor rated voltage | Rated Volt | 0 | 0, 170-480 | V |

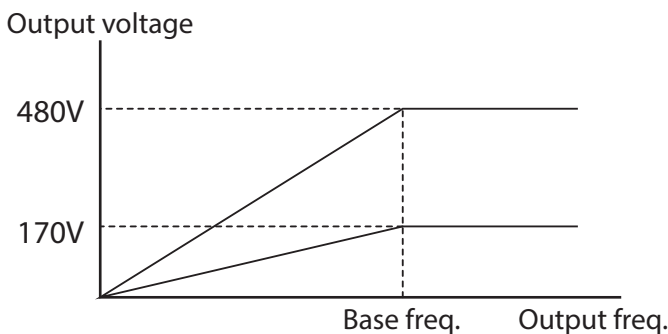

4.16 Start Mode Setting

Select the start mode to use when the operation command is input with the motor in the stopped condition.

4.16.1 Acceleration Start

Acceleration start is a general acceleration mode. If there are no extra settings applied, the motor accelerates directly to the frequency reference when the command is input.

| Group | Code | Name | LCD Display | Parameter Setting | | Setting Range | Unit |
|-------|------|------------|-------------|-------------------|-----|---------------|------|
| Ad | 07 | Start mode | Start mode | 0 | Acc | 0-1 | - |

4.16.2 Start After DC Braking

This start mode supplies a DC voltage for a set amount of time to provide DC braking before an inverter starts to accelerate a motor. If the motor continues to rotate due to its inertia, DC braking will stop the motor, allowing the motor to accelerate from a stopped condition. DC braking can also be used with a mechanical brake connected to a motor shaft when a constant torque load is applied, if a constant torque is required after the the mechanical brake is released.

| Group | Code | Name | LCD Display | Parameter Setting | | Setting Range | Unit |
|-------|------|-----------------------|---------------|-------------------|----------|---------------|------|
| Ad | 07 | Start mode | Start Mode | 1 | DC-Start | 0-1 | - |
| | 12 | Start DC braking time | DC-Start Time | 0.00 | | 0.00-60.00 | sec |
| | 13 | DC Injection Level | DC Inj Level | 50 | | 0-200 | % |

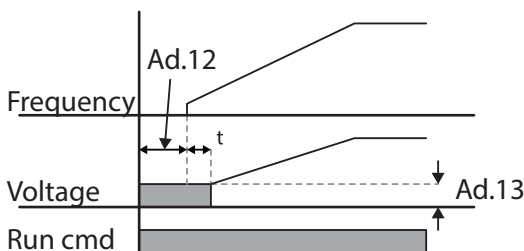

⚠ Caution

The amount of DC braking required is based on the motor's rated current. Do not use DC braking resistance values that can cause current draw to exceed the rated current of the inverter. If the DC braking resistance is too high or brake time is too long, the motor may overheat or be damaged.

4.17 Stop Mode Setting

Select a stop mode to stop the inverter operation.

4.17.1 Deceleration Stop

Deceleration stop is a general stop mode. If there are no extra settings applied, the motor decelerates down to 0Hz and stops, as shown in the figure below.

| Group | Code | Name | LCD Display | Parameter Setting | Setting Range | Unit |
|-------|------|-----------|-------------|-------------------|---------------|------|
| Ad | 08 | Stop mode | Stop Mode | 0 | Dec | 0-4 |

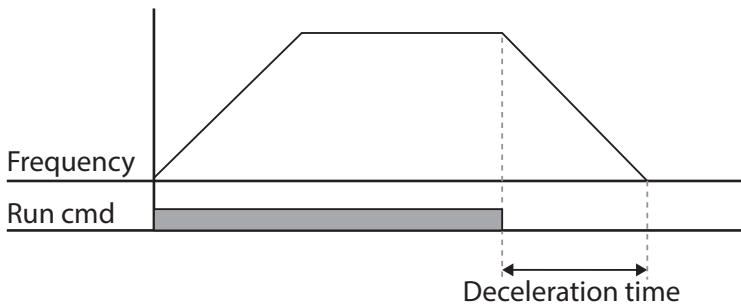

4.17.2 Stop After DC Braking

When the operation frequency reaches the set value during deceleration (DC braking frequency), the inverter stops the motor by supplying DC power to the motor. With a stop command input, the inverter begins decelerating the motor. When the frequency reaches the DC braking frequency set at Ad.17, the inverter supplies DC voltage to the motor and stops it.

| Group | Code | Name | LCD Display | Parameter Setting | Setting Range | Unit |
|-------|------|----------------------------------|----------------|-------------------|---------------|------|
| Ad | 08 | Stop mode | Stop Mode | 0 | Dec | 0-4 |
| | 14 | Output block time before braking | DC-Block Time | 0.10 | 0.00-60.00 | sec |
| | 15 | DC braking time | DC-Brake Time | 1.00 | 0-60 | sec |
| | 16 | DC braking amount | DC-Brake Level | 50 | 0-200 | % |
| | 17 | DC braking frequency | DC-Brake Freq | 5.00 | 0.00-60.00 | Hz |

DC Braking After Stop Setting Details

| Code | Description |
|----------------------|--|
| Ad.14 DC-Block Time | Set the time to block the inverter output before DC braking. If the inertia of the load is great, or if DC braking frequency (Ad.17) is set too high, a fault trip may occur due to overcurrent conditions when the inverter supplies DC voltage to the motor. Prevent overcurrent fault trips by adjusting the output block time before DC braking. |
| Ad.15 DC-Brake Time | Set the time duration for the DC voltage supply to the motor. |
| Ad.16 DC-Brake Level | Set the amount of DC braking to apply. The parameter setting is based on the rated current of the motor. |
| Ad.17 DC-Brake Freq | Set the frequency to start DC braking. When the frequency is reached, the inverter starts deceleration. If the dwell frequency is set lower than the DC braking frequency, dwell operation will not work and DC braking will start instead. |

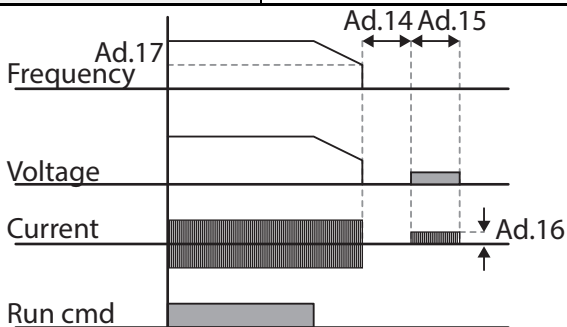

⚠ Caution

- Note that the motor can overheat or be damaged if excessive amount of DC braking is applied to the motor, or DC braking time is set too long.
- DC braking is configured based on the motor's rated current. To prevent overheating or damaging motors, do not set the current value higher than the inverter's rated current.

4.17.3 Free Run Stop

When the Operation command is off, the inverter output turns off, and the load stops due to residual inertia.

| Group | Code | Name | LCD Display | Parameter Setting | Setting Range | Unit | |
|-------|------|-------------|-------------|-------------------|---------------|------|---|
| Ad | 08 | Stop Method | Stop Mode | 2 | Free-Run | 0-4 | - |

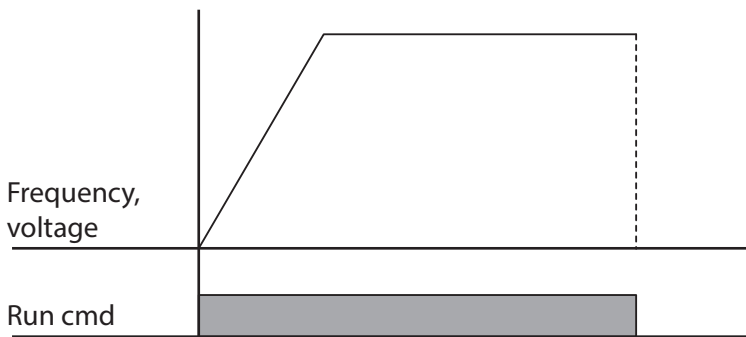

⚠ Caution

Note that when there is high inertia on the output side and the motor is operating at high speed, the load's inertia will cause the motor to continue rotating even if the inverter output is blocked.

4.17.4 Power Braking

When the inverter's DC voltage rises above a specified level due to motor regenerated energy, a control is made to either adjust the deceleration gradient level or reaccelerate the motor in order to reduce the regenerated energy. Power braking can be used when short deceleration times are needed without brake resistors, or when optimum deceleration is needed without causing an over voltage fault trip.

| Group | Code | Name | LCD Display | Parameter Setting | Setting Range | Unit |
|-------|------|-----------|-------------|-------------------|---------------|------|
| Ad | 08 | Stop mode | Stop Mode | 4 | Power Braking | 0-4 |

⚠ Caution

- To prevent overheating or damaging the motor, do not apply power braking to the loads that require frequent deceleration.
- Stall prevention and power braking only operate during deceleration, and power braking takes priority over stall prevention. In other words, when both Pr.50 (stall prevention and flux braking) and Ad.08 (power braking) are set, power braking will take precedence and operate.
- Note that if deceleration time is too short or inertia of the load is too great, an overvoltage fault trip may occur.
- Note that if a free run stop is used, the actual deceleration time can be longer than the pre-set deceleration time.

4.18 Frequency Limit

Operation frequency can be limited by setting maximum frequency, start frequency, upper limit frequency and lower limit frequency.

4.18.1 Frequency Limit Using Maximum Frequency and Start Frequency

| Group | Code | Name | LCD Display | Parameter Setting | Setting Range | Unit |
|-------|------|-------------------|-------------|-------------------|---------------|------|
| dr | 19 | Start frequency | Start Freq | 0.50 | 0.01-10.00 | Hz |
| | 20 | Maximum frequency | Max Freq | 60.00 | 40.00-400.00 | Hz |

Frequency Limit Using Maximum Frequency and Start Frequency - Setting Details

| Code | Description |
|------------------|--|
| dr.19 Start Freq | Set the lower limit value for speed unit parameters that are expressed in Hz or rpm. If an input frequency is lower than the start frequency, the parameter value will be 0.00. |
| dr.20 Max Freq | Set upper and lower frequency limits. All frequency selections are restricted to frequencies from within the upper and lower limits. This restriction also applies when you in input a frequency reference using the keypad. |

4.18.2 Frequency Limit Using Upper and Lower Limit Frequency Values

| Group | Code | Name | LCD Display | Parameter Setting | Setting Range | Unit |
|-------|------|-----------------------------|---------------|-------------------|---------------------------|------|
| Ad | 24 | Frequency limit | Freq Limit | 0 No | 0-1 | - |
| | 25 | Frequency lower limit value | Freq Limit Lo | 0.50 | 0.0-maximum frequency | Hz |
| | 26 | Frequency upper limit value | Freq Limit Hi | Maximum frequency | minimum-maximum frequency | Hz |

Frequency Limit Using Upper and Lower Limit Frequencies - Setting Details

| Code | Description |
|--|---|
| Ad.24 Freq Limit | The initial setting is 0(No). Changing the setting to 1(Yes) allows the setting of frequencies between the lower limit frequency (Ad.25) and the upper limit frequency (Ad.26). When the setting is 0(No), codes Ad.25 and Ad.26 are not visible. |
| Ad.25 Freq Limit Lo, Ad.26 Freq Limit Hi | Set an upper limit frequency to all speed unit parameters that are expressed in Hz or rpm, except for the base frequency (dr.18). Frequency cannot be set higher than the upper limit frequency. |

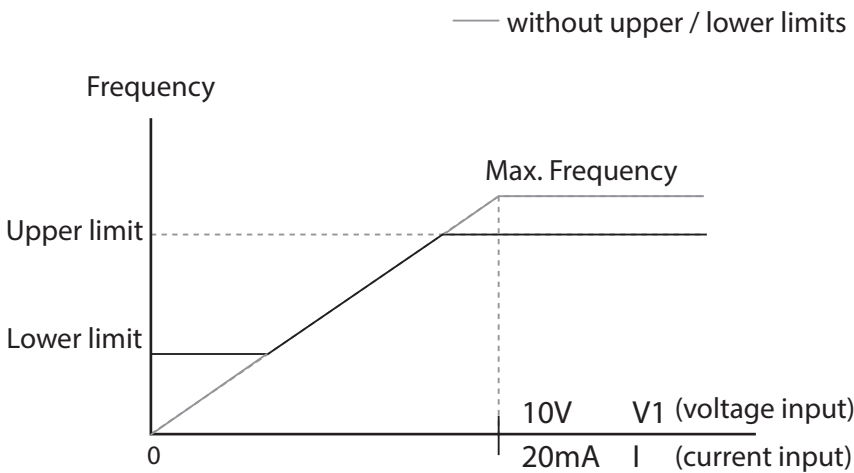

4.18.3 Frequency Jump

Use frequency jump to avoid mechanical resonance frequencies. Jump through frequency bands when a motor accelerates and decelerates. Operation frequencies cannot be set within the pre-set frequency jump band.

When a frequency setting is increased, while the frequency parameter setting value (voltage, current, RS-485 communication, keypad setting, etc.) is within a jump frequency band, the frequency will be maintained at the lower limit value of the frequency band. Then, the frequency will increase when the frequency parameter setting exceeds the range of frequencies used by the frequency jump band.

| Group | Code | Name | LCD Display | Parameter Setting | | Setting Range | Unit |
|-------|------|-----------------------------|-------------|-------------------|----|-----------------------------------|------|
| Ad | 27 | Frequency jump | Jump Freq | 0 | No | 0-1 | - |
| | 28 | Jump frequency lower limit1 | Jump Lo 1 | 10.00 | | 0.00-Jump frequency upper limit 1 | Hz |

| Group | Code | Name | LCD Display | Parameter Setting | Setting Range | Unit |
|-------|------|------------------------------|-------------|-------------------|--|------|
| | 29 | Jump frequency upper limit 1 | Jump Hi 1 | 15.00 | Jump frequency lower limit 1-Maximum frequency | Hz |
| | 30 | Jump frequency lower limit 2 | Jump Lo 2 | 20.00 | 0.00-Jump frequency upper limit 2 | Hz |
| | 31 | Jump frequency upper limit 2 | Jump Hi 2 | 25.00 | Jump frequency lower limit 2-Maximum frequency | Hz |
| | 32 | Jump frequency lower limit 3 | Jump Lo 3 | 30.00 | 0.00-Jump frequency upper limit 3 | Hz |
| | 33 | Jump frequency upper limit 3 | Jump Hi 3 | 35.00 | Jump frequency lower limit 3-Maximum frequency | Hz |

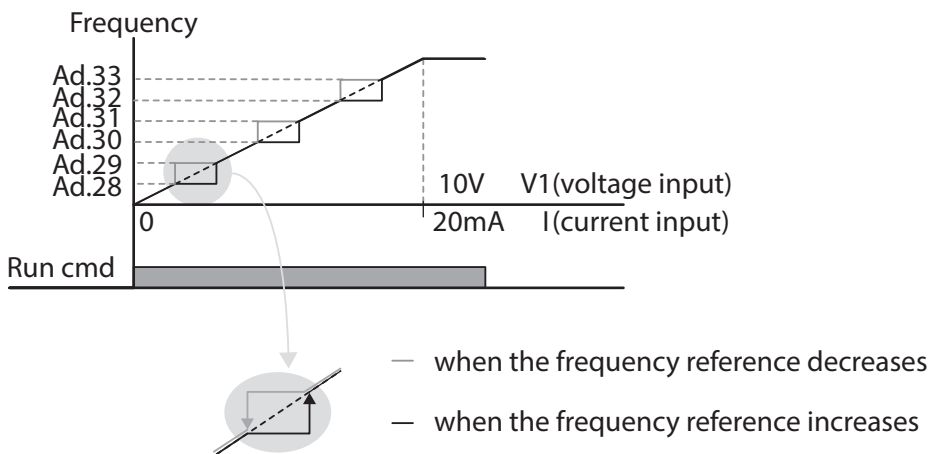

4.19 2nd Operation Mode Setting

Apply two types of operation modes and switch between them as required. For both the first and second command source, set the frequency after shifting operation commands to the multi-function input terminal. Mode switching can be used to stop remote control during an operation using the communication option and to switch operation mode to operate via the local panel, or to operate the inverter from another remote control location.

Select one of the multi-function terminals from codes In. 65-71 and set the parameter value to 15 (2nd Source).

| Group | Code | Name | LCD Display | Parameter Setting | Setting Range | Unit |
|---------------|------|----------------------------|--------------|-------------------|---------------|------|
| Opera tion | drv | Command source | Cmd Source* | 1 Fx/Rx-1 | 0-5 | - |
| | Frq | Frequency reference source | Freq Ref Src | 2 V1 | 0-12 | - |

| Group | Code | Name | LCD Display | Parameter Setting | | Setting Range | Unit |
|-------|-------|--|--------------------------|-------------------|------------|---------------|------|
| bA | 04 | 2 nd Command source | Cmd 2nd Src | 0 | Keypad | 0–4 | - |
| | 05 | 2 nd Frequency reference source | Freq 2nd Src | 0 | KeyPad-1 | 0–12 | - |
| In | 65-71 | Px terminal configuration | Px Define (Px: P1-P7) | 15 | 2nd Source | 0–54 | - |

* Displayed under DRV-06 in an LCD keypad.

2nd Operation Mode Setting Details

| Code | Description |
|---|---|
| bA.04 Cmd 2nd Src bA.05 Freq 2nd Src | If signals are provided to the multi-function terminal set as the 2 nd command source (2nd Source), the operation can be performed using the set values from bA.04-05 instead of the set values from the drv and Frq codes in the Operation group. The 2nd command source settings cannot be changed while operating with the 1 st command source (Main Source). |

⚠ Caution

- When setting the multi-function terminal to the 2nd command source (2nd Source) and input (On) the signal, operation state is changed because the frequency setting and the Operation command will be changed to the 2nd command. Before shifting input to the multi-function terminal, ensure that the 2nd command is correctly set. Note that if the deceleration time is too short or inertia of the load is too high, an overvoltage fault trip may occur.
- Depending on the parameter settings, the inverter may stop operating when you switch the command modes.

4.20 Multi-function Input Terminal Control





































Filter time constants and the type of multi-function input terminals can be configured to improve the response of input terminals

| Group | Code | Name | LCD Display | Parameter Setting | Setting Range | Unit |
|-------|------|--|--------------|-------------------|---------------|------|
| In | 85 | Multi-function input terminal On filter | DI On Delay | 10 | 0-10000 | ms |
| | 86 | Multi-function input terminal Off filter | DI Off Delay | 3 | 0-10000 | ms |
| | 87 | Multi-function input terminal selection | DI NC/NO Sel | 0 0000* | - | - |

| Group | Code | Name | LCD Display | Parameter Setting | Setting Range | Unit |
|-------|------|--------------------------------------|-------------|-------------------|---------------|------|
| | 90 | Multi-function input terminal status | DI Status | 0 0000* | - | - |

* Displayed as  on the keypad.

Multi-function Input Terminal Control Setting Details

| Code | Description | | | | | | | | | |
|---------------------------------------|--|---|-------------------------------------|-----------------------------------|--------|---|---|------------|---|---|
| In.84 DI Delay Sel | Select whether or not to activate the time values set at In.85 and In.86. If deactivated, the time values are set to the default values at In.85 and In.86. If activated, the set time values at In.85 and In.86 are set to the corresponding terminals. | | | | | | | | | |
| | <table border="1"> <thead> <tr> <th>Type</th> <th>B terminal status (Normally Closed)</th> <th>A terminal status (Normally Open)</th> </tr> </thead> <tbody> <tr> <td>Keypad</td> <td></td> <td></td> </tr> <tr> <td>LCD keypad</td> <td></td> <td></td> </tr> </tbody> </table> | Type | B terminal status (Normally Closed) | A terminal status (Normally Open) | Keypad |  |  | LCD keypad |  |  |
| | Type | B terminal status (Normally Closed) | A terminal status (Normally Open) | | | | | | | |
| Keypad |  |  | | | | | | | | |
| LCD keypad |  |  | | | | | | | | |
| | | | | | | | | | | |
| In.85 DI On Delay, In.86 DI Off Delay | If the input terminal's state is not changed during the set time, when the terminal receives an input, it is recognized as On or Off. | | | | | | | | | |
| In.87 DI NC/NO Sel | Select terminal contact types for each input terminal. The position of the indicator light corresponds to the segment that is on as shown in the table below. With the bottom segment on, it indicates that the terminal is configured as a A terminal (Normally Open) contact. With the top segment on, it indicates that the terminal is configured as a B terminal (Normally Closed) contact. Terminals are numbered P1-P7, from right to left. | | | | | | | | | |
| | <table border="1"> <thead> <tr> <th>Type</th> <th>B terminal status (Normally Closed)</th> <th>A terminal status (Normally Open)</th> </tr> </thead> <tbody> <tr> <td>Keypad</td> <td></td> <td></td> </tr> <tr> <td>LCD keypad</td> <td></td> <td></td> </tr> </tbody> </table> | Type | B terminal status (Normally Closed) | A terminal status (Normally Open) | Keypad |  |  | LCD keypad |  |  |
| | Type | B terminal status (Normally Closed) | A terminal status (Normally Open) | | | | | | | |
| Keypad |  |  | | | | | | | | |
| LCD keypad |  |  | | | | | | | | |
| | | | | | | | | | | |
| In.90 DI Status | Display the configuration of each contact. When a segment is configured as A terminal using dr.87, the On condition is indicated by the top segment turning on. The Off condition is indicated when the bottom segment is turned on. When contacts are configured as B terminals, the segment lights behave conversely. Terminals are numbered P1-P7, from right to left. | | | | | | | | | |
| | <table border="1"> <thead> <tr> <th>Type</th> <th>A terminal setting (On)</th> <th>A terminal setting (Off)</th> </tr> </thead> <tbody> <tr> <td>Keypad</td> <td></td> <td></td> </tr> <tr> <td>LCD keypad</td> <td></td> <td></td> </tr> </tbody> </table> | Type | A terminal setting (On) | A terminal setting (Off) | Keypad |  |  | LCD keypad |  |  |
| | Type | A terminal setting (On) | A terminal setting (Off) | | | | | | | |
| Keypad |  |  | | | | | | | | |
| LCD keypad |  |  | | | | | | | | |
| | | | | | | | | | | |

4.21 P2P Setting

The P2P function is used to share input and output devices between multiple inverters. To enable P2P setting, RS-485 communication must be turned on .

Inverters connected through P2P communication are designated as either a master or slaves . The Master inverter controls the input and output of slave inverters. Slave inverters provide input and output actions. When using the multi-function output, a slave inverter can select to use either the master inverter's output or its own output. When using P2P communication, first designate the slave inverter and then the master inverter. If the master inverter is designated first, connected inverters may interpret the condition as a loss of communication.

Master Parameter

| Group | Code | Name | LCD Display | Parameter Setting | | Setting Range | Unit |
|-------|------|-----------------------------|--------------|-------------------|------------|----------------|------|
| CM | 95 | P2P Communication selection | Int 485 Func | 1 | P2P Master | 0-3 | - |
| US | 80 | Analog input1 | P2P In V1 | 0 | | 0-12,000 | % |
| | 81 | Analog input2 | P2P In I2 | 0 | | -12,000-12,000 | % |
| | 82 | Digital input | P2P In DI | 0 | | 0-0x7F | bit |
| | 85 | Analog output | P2P Out AO1 | 0 | | 0-10,000 | % |
| | 88 | Digital output | P2P Out DO | 0 | | 0-0x03 | bit |

Slave Parameter

| Group | Code | Name | LCD Display | Parameter Setting | | Setting Range | Unit |
|-------|------|-----------------------------|--------------|-------------------|-----------|---------------|------|
| CM | 95 | P2P Communication selection | Int 485 Func | 2 | P2P Slave | 0-3 | - |
| | 96 | P2P DO setting selection | P2P OUT Sel | 0 | No | 0-2 | bit |

P2P Setting Details

| Code | Description |
|---------------------------|---|
| CM.95 Int 485 Func | Set master inverter to 1(P2P Master), slave inverter to 2(P2P Slave). |
| US.80-82 P2P Input Data | Input data sent from the slave inverter. |
| US.85, 88 P2P Output Data | Output data transmitted to the slave inverter. |

ⓘ Caution

- P2P features work only with code version 1.00, IO S/W version 0.11, and keypad S/W version 1.07 or higher versions.
- Set the user sequence functions to use P2P features..

4.22 Multi-keypad Setting

Use multi-keypad settings to control more than one inverter with one keypad. To use this function, first configure RS-485 communication.

The group of inverters to be controlled by the keypad will include a master inverter. The master inverter monitors the other inverters, and slave inverter responds to the master inverter's input. When using multi-function output, a slave inverter can select to use either the master inverter's output or its own output. When using the multi keypad, first designate the slave inverter and then the master inverter. If the master inverter is designated first, connected inverters may interpret the condition as a loss of communication.

Master Parameter

| Group | Code | Name | LCD Display | Parameter Setting | | Setting Range | Unit |
|-------|------|------------------------------|---------------|-------------------|-----------|---------------|------|
| CM | 95 | P2P Communication selection | Int 485 Func | 3 | KPD-Ready | 0-3 | - |
| CNF | 03 | Multi-keypad ID | Multi KPD ID | 3 | | 3-99 | - |
| | 42 | Multi-function key selection | Multi Key Sel | 4 | Multi KPD | 0-4 | - |

Slave Parameter

| Group | Code | Name | LCD Display | Parameter Setting | | Setting Range | Unit |
|-------|------|---------------------------|--------------|-------------------|-----------|---------------|------|
| CM | 01 | Station ID | Int485 St ID | 3 | | 3-99 | - |
| | 95 | P2P communication options | Int 485 Func | 3 | KPD-Ready | 0-3 | - |

Multi-keypad Setting Details

| Code | Description |
|----------------------|--|
| CM.01 Int485 St ID | Prevents conflict by designating a unique identification value to an inverter. Values can be selected from numbers between 3-99. |
| CM.95 Int 485 Func | Set the value to 3(KPD-Ready) for both master and slave inverter |
| CNF-03 Multi KPD ID | Select an inverter to monitor from the group of inverters. |
| CNF-42 Multi key Sel | Select a multi-function key type 4(Multi KPD). |

ⓘ Caution

- Multi-keypad (Multi-KPD) features work only with code version 1.00, IO S/W version 0.11, and keypad S/W version 1.07 or higher versions.
- The multi-keypad feature will not work when the multi-keypad ID (CNF-03 Multi-KPD ID) setting is identical to the RS-485 communication station ID (CM-01 Int485 st ID) setting.
- The master/slave setting cannot be changed while the inverter is operating in slave mode.

4.23 User Sequence Setting

User Sequence creates a simple sequence from a combination of different function blocks. The sequence can comprise of a maximum of 18 steps using 29 function blocks and 30 void parameters.

1 Loop refers to a single execution of a user configured sequence that contains a maximum of 18 steps. Users can select a Loop Time of between 10-1,000ms.

The codes for user sequences configuration can be found in the US group (for user sequence settings) and the UF group (for function block settings).

| Group | Code | Name | LCD Display | Parameter Setting | Setting Range | Unit |
|-------|-------|---------------------------------|---------------------|-------------------|---------------|------|
| AP | 02 | User sequence activation | User Seq En | 0 | 0-1 | - |
| US | 01 | User sequence operation command | User Seq Con | 0 | 0-2 | - |
| | 02 | User sequence operation time | User Loop Time | 0 | 0-5 | - |
| | 11-28 | Output address link1-18 | Link UserOut1-18 | 0 | 0-0xFFFF | - |
| | 31-60 | Input value setting1-30 | Void Para1-30 | 0 | -9999-9999 | - |
| | 80 | Analog input 1 | P2P In V1(-10-10 V) | 0 | 0-12,000 | % |
| | 81 | Analog input 2 | P2P In I2 | 0 | -12,000 | % |
| | 82 | Digital input | P2P In D | 0 | -12,000 | bit |
| | 85 | Analog output | P2P Out AO1 | 0 | 0-0x7F | % |
| | 88 | Digital output | P2P Out DO | 0 | 0-0x03 | bit |
| UF | 01 | User function 1 | User Func1 | 0 | 0-28 | - |
| | 02 | User function input 1-A | User Input 1-A | 0 | 0-0xFFFF | - |
| | 03 | User function input 1-B | User Input 1-B | 0 | 0-0xFFFF | - |
| | 04 | User function input 1-C | User Input 1-C | 0 | 0-0xFFFF | - |
| | 05 | User function output 1 | User Output 1 | 0 | -32767-32767 | - |
| | 06 | User function 2 | User Func2 | 0 | 0-28 | - |
| | 07 | User function input 2-A | User Input 2-A | 0 | 0-0xFFFF | - |
| | 08 | User function input 2-B | User Input 2-B | 0 | 0-0xFFFF | - |
| | 09 | User function input 2-C | User Input 2-C | 0 | 0-0xFFFF | - |
| | 10 | User function output 2 | User Output 2 | 0 | -32767-32767 | - |
| | 11 | User function 3 | User Func3 | 0 | 0-28 | - |
| | 12 | User function input 3-A | User Input 3-A | 0 | 0-0xFFFF | - |
| | 13 | User function input 3-B | User Input 3-B | 0 | 0-0xFFFF | - |

| Group | Code | Name | LCD Display | Parameter Setting | Setting Range | Unit |
|-------|------|--------------------------|-----------------|-------------------|---------------|------|
| | 14 | User function input 3-C | User Input 3-C | 0 | 0-0xFFFF | - |
| | 15 | User function output 3 | User Output 3 | 0 | -32767-32767 | - |
| | 16 | User function 4 | User Func4 | 0 | 0-28 | - |
| | 17 | User function input 4-A | User Input 4-A | 0 | 0-0xFFFF | - |
| | 18 | User function input 4-B | User Input 4-B | 0 | 0-0xFFFF | - |
| | 19 | User function input 4-C | User Input 4-C | 0 | 0-0xFFFF | - |
| | 20 | User function output 4 | User Output 4 | 0 | -32767-32767 | - |
| | 21 | User function 5 | User Func5 | 0 | 0-28 | - |
| | 22 | User function input 5-A | User Input 5-A | 0 | 0-0xFFFF | - |
| | 23 | User function input 5-B | User Input 5-B | 0 | 0-0xFFFF | - |
| | 24 | User function input 5-C | User Input 5-C | 0 | 0-0xFFFF | - |
| | 25 | User function output 5 | User Output 5 | 0 | -32767-32767 | - |
| | 26 | User function 6 | User Func6 | 0 | 0-28 | - |
| | 27 | User function input 6-A | User Input 6-A | 0 | 0-0xFFFF | - |
| | 28 | User function input 6-B | User Input 6-B | 0 | 0-0xFFFF | - |
| | 29 | User function input 6-C | User Input 6-C | 0 | 0-0xFFFF | - |
| | 30 | User function output 6 | User Output 6 | 0 | -32767-32767 | - |
| | 31 | User function 7 | User Func7 | 0 | 0-28 | - |
| | 32 | User function input 7-A | User Input 7-A | 0 | 0-0xFFFF | - |
| | 33 | User function input 7-B | User Input 7-B | 0 | 0-0xFFFF | - |
| | 34 | User function input 7-C | User Input 7-C | 0 | 0-0xFFFF | - |
| | 35 | User function output 7 | User Output 7 | 0 | -32767-32767 | - |
| | 36 | User function 8 | User Func8 | 0 | 0-28 | - |
| | 37 | User function input 8-A | User Input 8-A | 0 | 0-0xFFFF | - |
| | 38 | User function input 8-B | User Input 8-B | 0 | 0-0xFFFF | - |
| | 39 | User function input 8-C | User Input 8-C | 0 | 0-0xFFFF | - |
| | 40 | User function output 8 | User Output 8 | 0 | -32767-32767 | - |
| | 41 | User function 9 | User Func9 | 0 | 0-28 | - |
| | 42 | User function input 9-A | User Input 9-A | 0 | 0-0xFFFF | - |
| | 43 | User function input 9-B | User Input 9-B | 0 | 0-0xFFFF | - |
| | 44 | User function input 9-C | User Input 9-C | 0 | 0-0xFFFF | - |
| | 45 | User function output 9 | User Output 9 | 0 | -32767-32767 | - |
| | 46 | User function 10 | User Func10 | 0 | 0-28 | - |
| | 47 | User function input 10-A | User Input 10-A | 0 | 0-0xFFFF | - |
| | 48 | User function input 10-B | User Input 10-B | 0 | 0-0xFFFF | - |

| Group | Code | Name | LCD Display | Parameter Setting | Setting Range | Unit |
|-------|------|--------------------------|-----------------|-------------------|---------------|------|
| | 49 | User function input 10-C | User Input 10-C | 0 | 0-0xFFFF | - |
| | 50 | User function output 10 | User Output 10 | 0 | -32767-32767 | - |
| | 51 | User function 11 | User Func11 | 0 | 0-28 | - |
| | 52 | User function input 11-A | User Input 11-A | 0 | 0-0xFFFF | - |
| | 53 | User function input 11-B | User Input 11-B | 0 | 0-0xFFFF | - |
| | 54 | User function input 11-C | User Input 11-C | 0 | 0-0xFFFF | - |
| | 55 | User function output 11 | User Output 11 | 0 | -32767-32767 | - |
| | 56 | User function 12 | User Func12 | 0 | 0-28 | - |
| | 57 | User function input 12-A | User Input 12-A | 0 | 0-0xFFFF | - |
| | 58 | User function input 12-B | User Input 12-B | 0 | 0-0xFFFF | - |
| | 59 | User function input 12-C | User Input 12-C | 0 | 0-0xFFFF | - |
| | 60 | User function output 12 | User Output 12 | 0 | -32767-32767 | - |
| | 61 | User function 13 | User Func13 | 0 | 0-28 | - |
| | 62 | User function input 13-A | User Input 13-A | 0 | 0-0xFFFF | - |
| | 63 | User function input 13-B | User Input 13-B | 0 | 0-0xFFFF | - |
| | 64 | User function input 13-C | User Input 13-C | 0 | 0-0xFFFF | - |
| | 65 | User function output 13 | User Output 13 | 0 | -32767-32767 | - |
| | 66 | User function 14 | User Func14 | 0 | 0-28 | - |
| | 67 | User function input 14-A | User Input 14-A | 0 | 0-0xFFFF | - |
| | 68 | User function input 14-B | User Input 14-B | 0 | 0-0xFFFF | - |
| | 69 | User function input 14-C | User Input 14-C | 0 | 0-0xFFFF | - |
| | 70 | User function output 14 | User Output 14 | 0 | -32767-32767 | - |
| | 71 | User function 15 | User Func15 | 0 | 0-28 | - |
| | 72 | User function input 15-A | User Input 15-A | 0 | 0-0xFFFF | - |
| | 73 | User function input 15-B | User Input 15-B | 0 | 0-0xFFFF | - |
| | 74 | User function input 15-C | User Input 15-C | 0 | 0-0xFFFF | - |
| | 75 | User function output 15 | User Output 15 | 0 | -32767-32767 | - |
| | 76 | User function 16 | User Func16 | 0 | 0-28 | - |
| | 77 | User function input 16-A | User Input 16-A | 0 | 0-0xFFFF | - |
| | 78 | User function input 16-B | User Input 16-B | 0 | 0-0xFFFF | - |
| | 79 | User function input 16-C | User Input 16-C | 0 | 0-0xFFFF | - |
| | 80 | User function output 16 | User Output 16 | 0 | -32767-32767 | - |
| | 81 | User function 17 | User Func17 | 0 | 0-28 | - |
| | 82 | User function input 17-A | User Input 17-A | 0 | 0-0xFFFF | - |
| | 83 | User function input 17-B | User Input 17-B | 0 | 0-0xFFFF | - |

| Group | Code | Name | LCD Display | Parameter Setting | Setting Range | Unit |
|-------|------|--------------------------|-----------------|-------------------|---------------|------|
| | 84 | User function input 17-C | User Input 17-C | 0 | 0-0xFFFF | - |
| | 85 | User function output 17 | User Output 17 | 0 | -32767-32767 | - |
| | 86 | User function 18 | User Func18 | 0 | 0-28 | - |
| | 87 | User function input 18-A | User Input 18-A | 0 | 0-0xFFFF | - |
| | 88 | User function input 18-B | User Input 18-B | 0 | 0-0xFFFF | - |
| | 89 | User function input 18-C | User Input 18-C | 0 | 0-0xFFFF | - |
| | 90 | User function output 18 | User Output 18 | 0 | -32767-32767 | - |

User Sequence Setting Details

| Code | Description |
|------------------------------|---|
| AP.02 User Seq En | Display the parameter groups related to a user sequence. |
| US.01 User Seq Con | Set Sequence Run and Sequence Stop with the keypad. Parameters cannot be adjusted during an operation. To adjust parameters, the operation must be stopped. |
| US.02 User Loop Time | Set the user sequence Loop Time. User sequence loop time can be set to 0.01s/0.02s/ 0.05s/0.1s/0.5s/1s. |
| US.11-28 Link UserOut1-18 | Set parameters to connect 18 Function Blocks. If the input value is 0x0000, an output value cannot be used. To use the output value in step 1 for the frequency reference (Cmd Frequency), input the communication address(0x1101) of the Cmd frequency as the Link UserOut1 parameter. |
| US.31-60 Void Para1-30 | Set 30 void parameters. Use when constant (Const) parameter input is needed in the user function block. |
| UF.01-90 | Set user defined functions for the 18 function blocks. If the function block setting is invalid, the output of the User Output@ is -1. All the outputs from the User Output@ are read only, and can be used with the user output link@ (Link UserOut@) of the US group. |

Function Block Parameter Structure

| Type | Description |
|----------------|---|
| User Func @* | Choose the function to perform in the function block. |
| User Input @-A | Communication address of the function's first input parameter. |
| User Input @-B | Communication address of the function's second input parameter. |
| User Input @-C | Communication address of the function's third input parameter. |
| User Output @ | Output value (Read Only) after performing the function block. |

* @ is the step number (1-18).

User Function Operation Condition

| Number | Type | Description |
|--------|------|---------------|
| 0 | NOP | No Operation. |

| Number | Type | Description |
|--------|--|---|
| 1 | ADD | Addition operation, $(A + B) + C$ If the C parameter is 0x0000, it will be recognized as 0. |
| 2 | SUB | Subtraction operation, $(A - B) - C$ If the C parameter is 0x0000, it will be recognized as 0. |
| 3 | ADDSUB | Addition and subtraction compound operation, $(A + B) - C$ If the C parameter is 0x0000, it will be recognized as 0. |
| 4 | MIN | Output the smallest value of the input values, $\text{MIN}(A, B, C)$. If the C parameter is 0x0000, operate only with A, B. |
| 5 | MAX | Output the largest value of the input values, $\text{MAX}(A, B, C)$. If the C parameter is 0x0000, operate only with A, B. |
| 6 | ABS | Output the absolute value of the A parameter, $ A $. This operation does not use the B, or C parameter. |
| 7 | NEGATE | Output the negative value of the A parameter, $-(A)$. This operation does not use the B, or C parameter. |
| 8 | REMAINDER | Remainder operation of A and B, $A \% B$ This operation does not use the C parameter. |
| 9 | MPYDIV | Multiplication, division compound operation, $(A \times B)/C$. If the C parameter is 0x0000, output the multiplication operation of $(A \times B)$. |
| 10 | COMPARE-GT (greater than) | Comparison operation: if $(A > B)$ the output is C; if $(A \leq B)$ the output is 0. If the condition is met, the output parameter is C. If the condition is not met, the output is 0(False). If the C parameter is 0x0000 and if the condition is met, the output is 1(True). |
| 11 | COMPARE-GTEQ (great than or equal to) | Comparison operation; if $(A \geq B)$ output is C; if $(A < B)$ the output is 0. If the condition is met, the output parameter is C. If the condition is not met, the output is 0(False). If the C parameter is 0x0000 and if the condition is met, the output is 1(True). |
| 12 | COMPARE-EQUAL | Comparison operation, if $(A == B)$ then the output is C. For all other values the output is 0. If the condition is met, the output parameter is C. if the condition is not met, the output is 0(False). If the C parameter is 0x0000 and if the condition is met, the output is 1(True). |
| 13 | COMPARE-NEQUAL | Comparison operation, if $(A != B)$ then the output is C. For all other values the output is 0. If the condition is met, the output parameter is C. If the condition is not met, the output is 0(False). If the C parameter is 0x0000 and if the condition is met, the output is 1(True). |
| 14 | TIMER | Adds 1 each time a user sequence completes a loop. A: Max Loop, B: Timer Run/Stop, C: Choose output mode. If input of B is 1, timer stops (output is 0). If input is 0, timer runs. If input of C is 1, output the current timer value. If input of C is 0, output 1 when timer value exceeds A(Max) value. If the C parameter is 0x0000, C will be recognized as 0. Timer overflow Initializes the timer value to 0. |
| 15 | LIMIT | Sets a limit for the A parameter. |

| Number | Type | Description |
|--------|---------------|--|
| | | If input to A is between B and C, output the input to A. If input to A is larger than B, output B. If input of A is smaller than C, output C. B parameter must be greater than or equal to the C parameter. |
| 16 | AND | Output the AND operation, (A and B) and C. If the C parameter is 0x0000, operate only with A, B. |
| 17 | OR | Output the OR operation, (A B) C. If the C parameter is 0x0000, operate only with A, B. |
| 18 | XOR | Output the XOR operation, (A ^ B) ^ C. If the C parameter is 0x0000, operate only with A, B. |
| 19 | AND/OR | Output the AND/OR operation, (A and B) C. If the C parameter is 0x0000, operate only with A, B. |
| 20 | SWITCH | Output a value after selecting one of two inputs, if (A) then B otherwise C. If the input at A is 1, the output will be B. If the input at A is 0, the output parameter will be C. |
| 21 | BITTEST | Test the B bit of the A parameter, BITTEST(A, B). If the B bit of the A input is 1, the output is 1. If it is 0, then the output is 0. The input value of B must be between 0-16. If the value is higher than 16, it will be recognized as 16. If input at B is 0, the output is always 0. |
| 22 | BITSET | Set the B bit of the A parameter, BITSET(A, B). Output the changed value after setting the B bit to input at A. The input value of B must be between 0-16. If the value is higher than 16, it will be recognized as 16. If the input at B is 0, the output is always 0. This operation does not use the C parameter. |
| 23 | BITCLEAR | Clear the B bit of the A parameter, BITCLEAR(A, B). Output the changed value after clearing the B bit to input at A. The input value of B must be between 0-16. If the value is higher than 16, it will be recognized as 16. If the input at B is 0, the output is always 0. This operation does not use the C parameter. |
| 24 | LOWPASSFILTER | Output the input at A as the B filter gains time constant, B x US-02 (US Loop Time). In the above formula, set the time when the output of A reaches 63.3% C stands for the filter operation. If it is 0, the operation is started. |
| 25 | PI_CONTROL | P, I gain = A, B parameter input, then output as C. Conditions for PI_PROCESS output: C = 0: Const PI, C = 1: PI_PROCESS-B >= PI_PROCESS-OUT >= 0, C = 2: PI_PROCESS-B >= PI_PROCESS-OUT >= -(PI_PROCESS-B), P gain = A/100, I gain = 1/(Bx Loop Time), If there is an error with PI settings, output -1. |
| 26 | PI_PROCESS | A is an input error, B is an output limit, C is the value of Const PI output. Range of C is 0-32,767. |
| 27 | UPCOUNT | Upcounts the pulses and then output the value- UPCOUNT(A, B, C). After receiving a trigger input (A), outputs are upcounted by C conditions. If |

| Number | Type | Description |
|--------|-----------|---|
| | | the B inputs is 1, do not operate and display 0. If the B inputs is 0, operate. If the C parameter is 0, upcount when the input at A changes from 0 to 1. If the C parameter is 1, upcount when the input at A is changed from 1 to 0. If the C parameter is 2, upcount whenever the input at A changes. Output range is: 0-32767 |
| 28 | DOWNCOUNT | Downcounts the pulses and then output the value- DOWNCOUNT(A, B, C). After receiving a trigger input (A), outputs are downcounted by C conditions. If the B input is 1, do not operate and display the initial value of C. If the B input is 0, operate. Downcounts when the A parameter changes from 0 to 1. |

Note

The PI process block (PI_PROCESS Block) must be used after the PI control block (PI_CONTROL Block) for proper PI control operation. PI control operation cannot be performed if there is another block between the two blocks, or if the blocks are placed in an incorrect order.

⚠ Caution

User sequence features work only with code version 1.00, IO S/W version 0.11, and keypad S/W version 1.07 or higher versions.

4.24 Fire Mode Operation

This function is used to allow the inverter to ignore minor faults during emergency situations, such as fire, and provides continuous operation to fire pumps.

When turned on, Fire mode forces the inverter to ignore all minor fault trips and repeat a Reset and Restart for major fault trips, regardless of the restart trial count limit. The retry delay time set at PR. 10 (Retry Delay) still applies while the inverter performs a Reset and Restart.

Fire Mode Parameter Settings

| Group | Code | Name | LCD Display | Parameter Setting | Setting Range | Unit |
|-------|------|-------------------------|----------------|-------------------|---------------|------|
| Ad | 80 | Fire Mode selection | Fire Mode Sel | 1 Fire Mode | 0-2 | - |
| | 81 | Fire Mode frequency | Fire Mode Freq | 0-60 | 0-60 | |
| | 82 | Fire Mode run direction | Fire Mode Dir | 0-1 | 0-1 | |
| | 83 | Fire Mode operation | Fire Mode | Not configurable | - | - |

| Group | Code | Name | LCD Display | Parameter Setting | | Setting Range | Unit |
|-------|-------|---------------------------|------------------------|-------------------|-----------|---------------|------|
| | | count | Cnt | | | | |
| In | 65–71 | Px terminal configuration | Px Define (Px: P1– P7) | 51 | Fire Mode | 0–54 | - |

The inverter runs in Fire mode when Ad. 80 (Fire Mode Sel) is set to '2 (Fire Mode)', and the multi-function terminal (In. 65-71) configured for Fire mode (51: Fire Mode) is turned on. The Fire mode count increases by 1 at Ad. 83 (Fire Mode Count) each time a Fire mode operation is run.

⚠ Caution

Fire mode operation may result in inverter malfunction. Note that Fire mode operation voids the product warranty – the inverter is covered by the product warranty only when the Fire mode count is '0.'

Fire Mode Function Setting Details

| Code | Description | Details |
|---|-------------------------------|---|
| Ad.81 Fire Mode frequency | Fire mode frequency reference | The frequency set at Ad. 81 (Fire mode frequency) is used for the inverter operation in Fire mode. The Fire mode frequency takes priority over the Jog frequency, Multi-step frequencies, and the keypad input frequency. |
| Dr.03 Acc Time / Dr.04 Dec Time | Fire mode Acc/Dec times | When Fire mode operation is turned on, the inverter accelerates for the time set at Dr.03 (Acc Time), and then decelerates based on the deceleration time set at Dr.04 (Dec Time). It stops when the Px terminal input is turned off (Fire mode operation is turned off). |
| PR.10 Retry Delay | Fault trip process | Some fault trips are ignored during Fire mode operation. The fault trip history is saved, but trip outputs are disabled even when they are configured at the multi-function output terminals. |
| | | <table border="1"> <thead> <tr> <th>Fault trips that are ignored in Fire mode</th> </tr> </thead> <tbody> <tr> <td>BX, External Trip, Low Voltage Trip, Inverter Overheat, Inverter Overload, Overload, Electrical Thermal Trip, Input/Output Open Phase, Motor Overload, Fan Trip, No Motor Trips, and other minor fault trips.</td> </tr> </tbody> </table> <p>For the following fault trips, the inverter performs a Reset and Restart until the trip conditions are released. The retry delay time set at PR. 10 (Retry Delay) applies while the inverter performs a Reset and Restart.</p> |
| Fault trips that are ignored in Fire mode | | |
| BX, External Trip, Low Voltage Trip, Inverter Overheat, Inverter Overload, Overload, Electrical Thermal Trip, Input/Output Open Phase, Motor Overload, Fan Trip, No Motor Trips, and other minor fault trips. | | |

| Code | Description | Details |
|------|-------------|--|
| | | <p data-bbox="518 272 1232 336">Fault trips that force a Reset Restart in Fire mode Over Voltage, Over Current1 (OC1), Ground Fault Trip</p> <p data-bbox="518 378 1215 405">The inverter stops operating when the following fault trips occur:</p> <p data-bbox="518 446 1232 510">Fault trips that stop inverter operation in Fire mode H/W Diag, Over Current 2 (Arm-Short)</p> |

5 Learning Advanced Features

This chapter describes the advanced features of the S100 inverter. Check the reference page in the table to see the detailed description for each of the advanced features.

| Advanced Tasks | Description | Ref. |
|-------------------------------|---|-----------------------|
| Auxiliary frequency operation | Use the main and auxiliary frequencies in the predefined formulas to create various operating conditions. Auxiliary frequency operation is ideal for Draw Operation* as this feature enables fine-tuning of operation speeds. | p.122 |
| Jog operation | Jog operation is a kind of a manual operation. The inverter operates to a set of parameter settings predefined for Jog operation, while the Jog command button is pressed. | p.126 |
| Up-down operation | Uses the upper and lower limit value switch output signals (i.e. signals from a flow meter) as Acc/Dec commands to motors. | p.129 |
| 3-wire operation | 3-wire operation is used to latch an input signal. This configuration is used to operate the inverter by a push button. | p.130 |
| Safety operation mode | This safety feature allows the inverter's operation only after a signal is input to the multi-function terminal designated for the safety operation mode. This feature is useful when extra care is needed in operating the inverter using the multi-purpose terminals. | p.131 |
| Dwell operation | Use this feature for the lift-type loads such as elevators, when the torque needs to be maintained while the brakes are applied or released. | p.133 |
| Slip compensation | This feature ensures that the motor rotates at a constant speed, by compensating for the motor slip as a load increases. | p.134 |
| PID control | PID control provides constant automated control of flow, pressure, and temperature by adjusting the output frequency of the inverter. | p.136 |
| Auto-tuning | Used to automatically measure the motor control parameters to optimize the inverter's control mode performance. | p.144 |
| Sensorless vector control | An efficient mode to control magnetic flux and torque without special sensors. Efficiency is achieved through the high torque characteristics at low current when compared with the V/F control mode. | p.147 |
| Energy buffering operation | Used to maintain the DC link voltage for as long as possible by controlling the inverter output frequency during power interruptions, thus to delay a low voltage fault trip. | p.154 |
| Energy saving operation | Used to save energy by reducing the voltage supplied to motors during low-load and no-load conditions. | p.156 |
| Speed search operation | Used to prevent fault trips when the inverter voltage is output while the motor is idling or free-running. | p.160 |
| Auto restart operation | Auto restart configuration is used to automatically restart the inverter when a trip condition is released, after the inverter stops operating due to activation of protective devices (fault trips). | p.164 |

| Advanced Tasks | Description | Ref. |
|--|--|-----------------------|
| Second motor operation | Used to switch equipment operation by connecting two motors to one inverter. Configure and operate the second motor using the terminal input defined for the second motor operation. | p.167 |
| Commercial power source switch operation | Used to switch the power source to the motor from the inverter output to a commercial power source, or vice versa. | p.168 |
| Cooling fan control | Used to control the cooling fan of the inverter. | p.169 |
| Timer settings | Set the timer value and control the On/Off state of the multi-function output and relay. | p.178 |
| Brake control | Used to control the On/Off operation of the load's electronic braking system. | p.179 |
| Multi-function output On/Off control | Set standard values and turn On/Off the output relays or multi-function output terminals according to the analog input value. | p.180 |
| Regeneration prevention for press operation. | Used during a press operation to avoid motor regeneration, by increasing the motor operation speed. | p.181 |

* Draw operation is an openloop tension control. This feature allows a constant tension to be applied to the material that is drawn by a motor-driven device, by fine-tuning the motor speed using operation frequencies that are proportional to a ratio of the main frequency reference.

5.1 Operating with Auxiliary References

Frequency references can be configured with various calculated conditions that use the main and auxiliary frequency references simultaneously. The main frequency reference is used as the operating frequency, while auxiliary references are used to modify and fine-tune the main reference.

| Group | Code | Name | LCD Display | Parameter Setting | | Setting Range | Unit |
|-----------|-------|--|---------------|-------------------|-------------|---------------|------|
| Operation | Frq | Frequency reference source | Freq Ref Src | 0 | Keypad-1 | 0-12 | - |
| bA | 01 | Auxiliary frequency reference source | Aux Ref Src | 1 | V1 | 0-4 | - |
| | 02 | Auxiliary frequency reference calculation type | Aux Calc Type | 0 | M+(G*A) | 0-7 | - |
| | 03 | Auxiliary frequency reference gain | Aux Ref Gain | 0.0 | | -200.0-200.0 | % |
| In | 65-71 | Px terminal configuration | Px Define | 40 | dis Aux Ref | 0~54 | - |

The table above lists the available calculated conditions for the main and auxiliary frequency references. Refer to the table to see how the calculations apply to an example where the Frq code has been set to 0(Keypad-1), and the inverter is operating at a main reference frequency of 30.00Hz. Signals at -10 – +10V are received at terminal V1, with the reference gain set at 5%. In this example, the resulting frequency reference is fine-tuned within the range of 27.00-33.00Hz [Codes In.01-16 must be set to the default values, and In.06 (V1 Polarity), set to 1 (Bipolar)].

Auxiliary Reference Setting Details

| Code | Description | | | | | | | | | | | | | | | | | | |
|--|--|---|---------------------------------|---|---|---|--|---|---|---|---|---|---|---|--|---|---|---|--|
| bA.01 Aux Ref Src | Set the input type to be used for the auxiliary frequency reference. | | | | | | | | | | | | | | | | | | |
| | <table border="1"> <thead> <tr> <th>Configuration</th> <th>Description</th> </tr> </thead> <tbody> <tr> <td>0</td> <td>None Auxiliary frequency reference is disabled.</td> </tr> <tr> <td>1</td> <td>V1 Sets the V1 (voltage) terminal at the control terminal block as the source of auxiliary frequency reference.</td> </tr> <tr> <td>3</td> <td>V2 Sets the V2 (voltage) terminal at the control terminal block as the source of auxiliary frequency reference (SW2 must be set to "voltage").</td> </tr> <tr> <td>4</td> <td>I2 Sets the I2 (current) terminal at the control terminal block as the source of auxiliary frequency reference (SW2 must be set to "current").</td> </tr> <tr> <td>5</td> <td>Pulse Sets the T1 (pulse) terminal at the control terminal block as the source of auxiliary frequency reference.</td> </tr> </tbody> </table> | Configuration | Description | 0 | None Auxiliary frequency reference is disabled. | 1 | V1 Sets the V1 (voltage) terminal at the control terminal block as the source of auxiliary frequency reference. | 3 | V2 Sets the V2 (voltage) terminal at the control terminal block as the source of auxiliary frequency reference (SW2 must be set to "voltage"). | 4 | I2 Sets the I2 (current) terminal at the control terminal block as the source of auxiliary frequency reference (SW2 must be set to "current"). | 5 | Pulse Sets the T1 (pulse) terminal at the control terminal block as the source of auxiliary frequency reference. | | | | | | |
| | Configuration | Description | | | | | | | | | | | | | | | | | |
| | 0 | None Auxiliary frequency reference is disabled. | | | | | | | | | | | | | | | | | |
| | 1 | V1 Sets the V1 (voltage) terminal at the control terminal block as the source of auxiliary frequency reference. | | | | | | | | | | | | | | | | | |
| | 3 | V2 Sets the V2 (voltage) terminal at the control terminal block as the source of auxiliary frequency reference (SW2 must be set to "voltage"). | | | | | | | | | | | | | | | | | |
| 4 | I2 Sets the I2 (current) terminal at the control terminal block as the source of auxiliary frequency reference (SW2 must be set to "current"). | | | | | | | | | | | | | | | | | | |
| 5 | Pulse Sets the T1 (pulse) terminal at the control terminal block as the source of auxiliary frequency reference. | | | | | | | | | | | | | | | | | | |
| bA.02 Aux Calc Type | Set the auxiliary reference gain with bA.03 (Aux Ref Gain) to configure the auxiliary reference and set the percentage to be reflected when calculating the main reference. Note that items 4–7 below may result in either plus (+) or minus (-) references (forward or reverse operation) even when unipolar analog inputs are used. | | | | | | | | | | | | | | | | | | |
| | <table border="1"> <thead> <tr> <th>Configuration</th> <th>Formula for frequency reference</th> </tr> </thead> <tbody> <tr> <td>0</td> <td>$M+(G \cdot A)$ Main reference+(bA.03xbA.01xIn.01)</td> </tr> <tr> <td>1</td> <td>$M \cdot (G \cdot A)$ $x(bA.03xbA.01)$</td> </tr> <tr> <td>2</td> <td>$M/(G \cdot A)$ Main reference/(bA.03xbA.01)</td> </tr> <tr> <td>3</td> <td>$M+\{M \cdot (G \cdot A)\}$ Main reference+{Main reference x(bA.03xbA.01)}</td> </tr> <tr> <td>4</td> <td>$M+G \cdot 2 \cdot (A-50)$ Main reference+bA.03x2x(bA.01-50)x In.01</td> </tr> <tr> <td>5</td> <td>$M \cdot \{G \cdot 2 \cdot (A-50)\}$ Main reference x{bA.03x2x(bA.01-50)}</td> </tr> <tr> <td>6</td> <td>$M/\{G \cdot 2 \cdot (A-50)\}$ Main reference/{bA.03x2x(bA.01-50)}</td> </tr> <tr> <td>7</td> <td>$M+M \cdot G \cdot 2 \cdot (A-50)$ Main reference+Main reference x bA.03x2x(bA.01-50)</td> </tr> </tbody> </table> | Configuration | Formula for frequency reference | 0 | $M+(G \cdot A)$ Main reference+(bA.03xbA.01xIn.01) | 1 | $M \cdot (G \cdot A)$ $x(bA.03xbA.01)$ | 2 | $M/(G \cdot A)$ Main reference/(bA.03xbA.01) | 3 | $M+\{M \cdot (G \cdot A)\}$ Main reference+{Main reference x(bA.03xbA.01)} | 4 | $M+G \cdot 2 \cdot (A-50)$ Main reference+bA.03x2x(bA.01-50)x In.01 | 5 | $M \cdot \{G \cdot 2 \cdot (A-50)\}$ Main reference x{bA.03x2x(bA.01-50)} | 6 | $M/\{G \cdot 2 \cdot (A-50)\}$ Main reference/{bA.03x2x(bA.01-50)} | 7 | $M+M \cdot G \cdot 2 \cdot (A-50)$ Main reference+Main reference x bA.03x2x(bA.01-50) |
| | Configuration | Formula for frequency reference | | | | | | | | | | | | | | | | | |
| | 0 | $M+(G \cdot A)$ Main reference+(bA.03xbA.01xIn.01) | | | | | | | | | | | | | | | | | |
| | 1 | $M \cdot (G \cdot A)$ $x(bA.03xbA.01)$ | | | | | | | | | | | | | | | | | |
| | 2 | $M/(G \cdot A)$ Main reference/(bA.03xbA.01) | | | | | | | | | | | | | | | | | |
| | 3 | $M+\{M \cdot (G \cdot A)\}$ Main reference+{Main reference x(bA.03xbA.01)} | | | | | | | | | | | | | | | | | |
| | 4 | $M+G \cdot 2 \cdot (A-50)$ Main reference+bA.03x2x(bA.01-50)x In.01 | | | | | | | | | | | | | | | | | |
| | 5 | $M \cdot \{G \cdot 2 \cdot (A-50)\}$ Main reference x{bA.03x2x(bA.01-50)} | | | | | | | | | | | | | | | | | |
| | 6 | $M/\{G \cdot 2 \cdot (A-50)\}$ Main reference/{bA.03x2x(bA.01-50)} | | | | | | | | | | | | | | | | | |
| 7 | $M+M \cdot G \cdot 2 \cdot (A-50)$ Main reference+Main reference x bA.03x2x(bA.01-50) | | | | | | | | | | | | | | | | | | |
| M: Main frequency reference (Hz or rpm) | | | | | | | | | | | | | | | | | | | |
| G: Auxiliary reference gain (%) | | | | | | | | | | | | | | | | | | | |
| A: Auxiliary frequency reference (Hz or rpm) or gain (%) | | | | | | | | | | | | | | | | | | | |

| Code | Description |
|--------------------|--|
| bA.03 Aux Ref Gain | Adjust the size of the input (bA.01 Aux Ref Src) configured for auxiliary frequency. |
| In.65–71 Px Define | Set one of the multi-function input terminals to 40(dis Aux Ref) and turn it on to disable the auxiliary frequency reference. The inverter will operate using the main frequency reference only. |

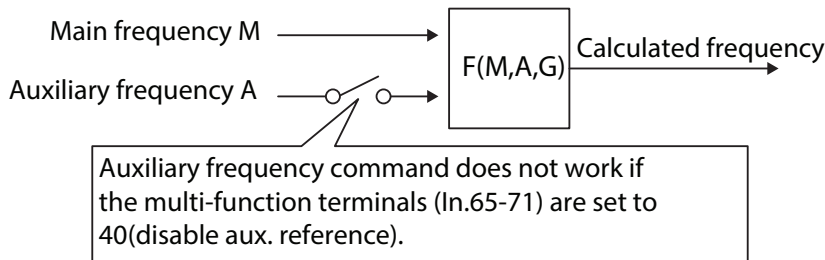

Auxiliary Reference Operation Ex #1

Keypad Frequency Setting is Main Frequency and V1 Analog Voltage is Auxiliary Frequency

- Main frequency: Keypad (operation frequency 30Hz)
- Maximum frequency setting (dr.20): 400Hz
- Auxiliary frequency setting (bA.01): V1 [Display by percentage(%) or auxiliary frequency (Hz) depending on the operation setting condition]
- Auxiliary reference gain setting (bA.03): 50%
- In.01–32: Factory default

Example: an input voltage of 6V is supplied to V1, and the frequency corresponding to 10V is 60Hz. The table below shows the auxiliary frequency A as 36Hz [= 60Hz X (6V/10V)] or 60% [= 100% X (6V/10V)].

| Setting* | Calculating final command frequency** |
|----------|--|
| 0 | $M[\text{Hz}] + (G[\%] * A[\text{Hz}])$ 30Hz(M) + (50%(G) x 36Hz(A)) = 48Hz |
| 1 | $M[\text{Hz}] * (G[\%] * A[\%])$ 30Hz(M) x (50%(G) x 60%(A)) = 9Hz |
| 2 | $M[\text{Hz}] / (G[\%] * A[\%])$ 30Hz(M) / (50%(G) x 60%(A)) = 100Hz |
| 3 | $M[\text{Hz}] + \{M[\text{Hz}] * (G[\%] * A[\%])\}$ 30Hz(M) + {30[Hz] x (50%(G) x 60%(A))} = 39Hz |
| 4 | $M[\text{Hz}] + G[\%] * 2 * (A[\%] - 50[\%]) [\text{Hz}]$ 30Hz(M) + 50%(G) x 2 x (60%(A) - 50%) x 60Hz = 36Hz |
| 5 | $M[\text{Hz}] * \{G[\%] * 2 * (A[\%] - 50[\%])\}$ 30Hz(M) x {50%(G) x 2 x (60%(A) - 50%)} = 3Hz |
| 6 | $M[\text{Hz}] / \{G[\%] * 2 * (A[\%] - 50[\%])\}$ 30Hz(M) / {50%(G) x 2 x (60% - 50%)} = 300Hz |
| 7 | $M[\text{Hz}] + M[\text{Hz}] * G[\%] * 2 * (A[\%] - 50[\%])$ 30Hz(M) + 30Hz(M) x 50%(G) x 2 x (60%(A) - 50%) = 33Hz |

*M: main frequency reference (Hz or rpm)/G: auxiliary reference gain (%)/A: auxiliary frequency reference (Hz or rpm) or gain (%).

**If the frequency setting is changed to rpm, it is converted to rpm instead of Hz.

Auxiliary Reference Operation Ex #2

Keypad Frequency Setting is Main Frequency and I2 Analog Voltage is Auxiliary Frequency

- Main frequency: Keypad (Operation frequency 30Hz)
- Maximum frequency setting (dr.20): 400Hz
- Auxiliary frequency setting (bA.01): I2 [Display by percentage(%) or auxiliary frequency(Hz) depending on the operation setting condition]
- Auxiliary reference gain setting (bA.03): 50%
- In.01–32: Factory default

Example: an input current of 10.4mA is applied to I2, with the frequency corresponding to 20mA of 60Hz. The table below shows auxiliary frequency A as 24Hz(=60[Hz] X {(10.4[mA]-4[mA])/(20[mA] - 4[mA])}) or 40%(=100[%] X {(10.4[mA] - 4[mA])/(20[mA] - 4[mA])}).

| Setting* | | Calculating final command frequency** |
|----------|--|---|
| 0 | $M[\text{Hz}] + (G[\%] * A[\text{Hz}])$ | $30\text{Hz}(M) + (50\%(G) \times 24\text{Hz}(A)) = 42\text{Hz}$ |
| 1 | $M[\text{Hz}] * (G[\%] * A[\%])$ | $30\text{Hz}(M) \times (50\%(G) \times 40\%(A)) = 6\text{Hz}$ |
| 2 | $M[\text{Hz}] / (G[\%] * A[\%])$ | $30\text{Hz}(M) / (50\%(G) \times 40\%(A)) = 150\text{Hz}$ |
| 3 | $M[\text{Hz}] + \{M[\text{Hz}] * (G[\%] * A[\%])\}$ | $30\text{Hz}(M) + \{30[\text{Hz}] \times (50\%(G) \times 40\%(A))\} = 36\text{Hz}$ |
| 4 | $M[\text{Hz}] + G[\%] * 2 * (A[\%] - 50[\%])[\text{Hz}]$ | $30\text{Hz}(M) + 50\%(G) \times 2 \times (40\%(A) - 50\%) \times 60\text{Hz} = 24\text{Hz}$ |
| 5 | $M[\text{Hz}] * \{G[\%] * 2 * (A[\%] - 50[\%])\}$ | $30\text{Hz}(M) \times \{50\%(G) \times 2 \times (40\%(A) - 50\%)\} = -3\text{Hz(Reverse)}$ |
| 6 | $M[\text{Hz}] / \{G[\%] * 2 * (A[\%] - 50[\%])\}$ | $30\text{Hz}(M) / \{50\%(G) \times 2 \times (60\% - 40\%)\} = -300\text{Hz(Reverse)}$ |
| 7 | $M[\text{Hz}] + M[\text{Hz}] * G[\%] * 2 * (A[\%] - 50[\%])$ | $30\text{Hz}(M) + 30\text{Hz}(M) \times 50\%(G) \times 2 \times (40\%(A) - 50\%) = 27\text{Hz}$ |

* M: main frequency reference (Hz or rpm)/G: auxiliary reference gain (%)/A: auxiliary frequency reference Hz or rpm) or gain (%).

**If the frequency setting is changed to rpm, it is converted to rpm instead of Hz.

Auxiliary Reference Operation Ex #3

V1 is Main Frequency and I2 is Auxiliary Frequency

- Main frequency: V1 (frequency command setting to 5V and is set to 30Hz)
- Maximum frequency setting (dr.20): 400Hz
- Auxiliary frequency (bA.01): I2[Display by percentage (%) or auxiliary frequency (Hz) depending on the operation setting condition]
- Auxiliary reference gain (bA.03): 50%
- In.01–32: Factory default

Example: an input current of 10.4mA is applied to I2, with the frequency corresponding to 20mA of 60Hz. The table below shows auxiliary frequency A as 24Hz(=60[Hz]x{(10.4[mA]-4[mA])/(20[mA]-

4[mA]}} or $40\% (= 100\% \times \{(10.4[mA] - 4[mA]) / (20[mA] - 4[mA])\}$.

| Setting* | | Calculating final command frequency** |
|----------|--|--|
| 0 | $M[\text{Hz}] + (G[\%] \times A[\text{Hz}])$ | $30\text{Hz}(M) + (50\%(G) \times 24\text{Hz}(A)) = 42\text{Hz}$ |
| 1 | $M[\text{Hz}] \times (G[\%] \times A[\%])$ | $30\text{Hz}(M) \times (50\%(G) \times 40\%(A)) = 6\text{Hz}$ |
| 2 | $M[\text{Hz}] / (G[\%] \times A[\%])$ | $30\text{Hz}(M) / (50\%(G) \times 40\%(A)) = 150\text{Hz}$ |
| 3 | $M[\text{Hz}] + \{M[\text{Hz}] \times (G[\%] \times A[\%])\}$ | $30\text{Hz}(M) + \{30[\text{Hz}] \times (50\%(G) \times 40\%(A))\} = 36\text{Hz}$ |
| 4 | $M[\text{Hz}] + G[\%] \times 2 \times (A[\%] - 50\%)[\text{Hz}]$ | $30\text{Hz}(M) + 50\%(G) \times 2 \times (40\%(A) - 50\%) \times 60\text{Hz} = 24\text{Hz}$ |
| 5 | $M[\text{Hz}] \times \{G[\%] \times 2 \times (A[\%] - 50\%)\}$ | $30\text{Hz}(M) \times \{50\%(G) \times 2 \times (40\%(A) - 50\%)\} = -3\text{Hz}(\text{Reverse})$ |
| 6 | $M[\text{Hz}] / \{G[\%] \times 2 \times (A[\%] - 50\%)\}$ | $30\text{Hz}(M) / \{50\%(G) \times 2 \times (60\% - 40\%)\} = -300\text{Hz}(\text{Reverse})$ |
| 7 | $M[\text{Hz}] + M[\text{Hz}] \times G[\%] \times 2 \times (A[\%] - 50\%)[\text{Hz}]$ | $30\text{Hz}(M) + 30\text{Hz}(M) \times 50\%(G) \times 2 \times (40\%(A) - 50\%) = 27\text{Hz}$ |

* M: main frequency reference (Hz or rpm)/G: auxiliary reference gain (%)/A: auxiliary frequency reference (Hz or rpm) or gain (%).

**If the frequency setting is changed to rpm, it is converted to rpm instead of Hz.

Note

When the maximum frequency value is high, output frequency deviation may result due to analog input variation and deviations in the calculations.

5.2 Jog operation

The jog operation allows for a temporary control of the inverter. You can enter a jog operation command using the multi-function terminals or by using the [ESC] key on the keypad.

The jog operation is the second highest priority operation, after the dwell operation. If a jog operation is requested while operating the multi-step, up-down, or 3-wire operation modes, the jog operation overrides all other operation modes.

5.2.1 Jog Operation 1-Forward Jog by Multi-function Terminal

The jog operation is available in either forward or reverse direction, using the keypad or multi-function terminal inputs. The table below lists parameter setting for a forward jog operation using the multi-function terminal inputs.

| Group | Code | Name | LCD Display | Parameter Setting | Setting Range | Unit |
|-------|------|---------------|---------------|-------------------|------------------------|------|
| dr | 11 | Jog frequency | JOG Frequency | 10.00 | 0.50-Maximum frequency | Hz |

| Group | Code | Name | LCD Display | Parameter Setting | Setting Range | Unit |
|-------|-------|---------------------------------|----------------------|-------------------|---------------|------|
| | 12 | Jog operation acceleration time | JOG Acc Time | 20.00 | 0.00-600.00 | sec |
| | 13 | Jog operation deceleration time | JOG Dec Time | 30.00 | 0.00-600.00 | sec |
| In | 65-71 | Px terminal configuration | Px Define(Px: P1-P7) | 6 JOG | - | - |

Forward Jog Description Details

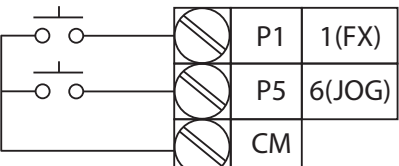
| Code | Description |
|---------------------|--|
| In.65-71 Px Define | Select the jog frequency from P1- P7 and then select 6. Jog from In.65-71.  <p>[Terminal settings for jog operation]</p> |
| dr.11 JOG Frequency | Set the operation frequency. |
| dr.12 JOG Acc Time | Set the acceleration speed. |
| dr.13 JOG Dec Time | Set the deceleration speed. |

If a signal is entered at the jog terminal while an FX operation command is on, the operation frequency changes to the jog frequency and the jog operation begins.

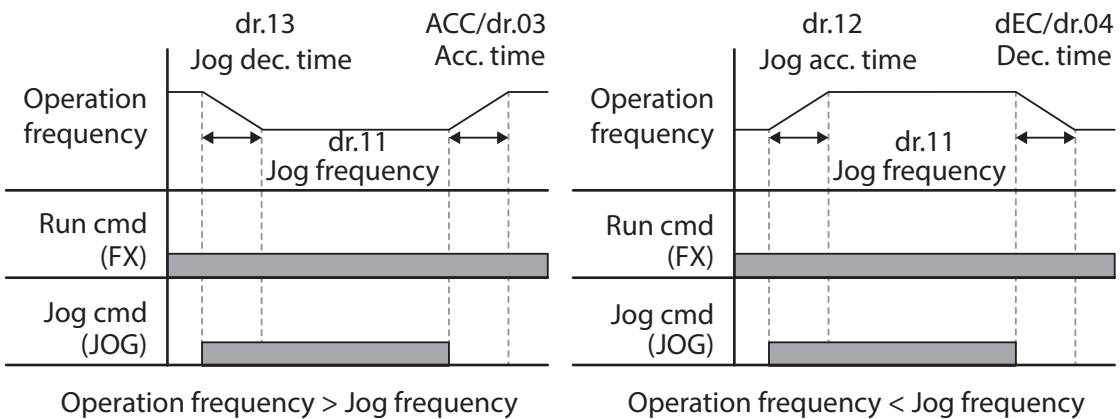

5.2.2 Jog Operation 2-Fwd/Rev Jog by Multi-function Terminal

For jog operation 1, an operation command must be entered to start operation, but while using jog operation 2, a terminal that is set for a forward or reverse jog also starts an operation. The priorities for frequency, Acc/Dec time and terminal block input during operation in relation to other operating modes (Dwell, 3-wire, up/down, etc.) are identical to jog operation 1. If a different operation command is entered during a jog operation, it is ignored and the operation maintains the jog frequency.

| Group | Code | Name | LCD Display | Parameter setting | Setting Range | Unit | |
|-------|-------|---------------------------------|----------------------|-------------------|------------------------|------|---|
| dr | 11 | Jog frequency | JOG Frequency | 10.00 | 0.50-Maximum frequency | Hz | |
| | 12 | Jog operation acceleration time | JOG Acc Time | 20.00 | 0.00-600.00 | sec | |
| | 13 | Operation deceleration time | JOG Dec Time | 30.00 | 0.00-600.00 | sec | |
| In | 65-71 | Px terminal configuration | Px Define(Px: P1-P7) | 46 | FWD JOG | - | - |
| | | | | 47 | REV JOG | | |

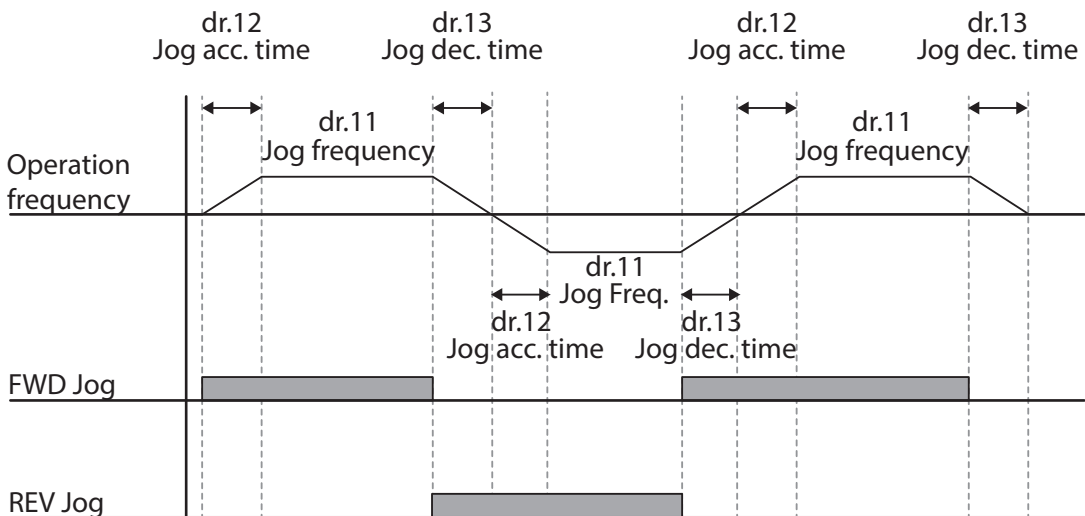

5.2.3 Jog Operation by Keypad

| Group | Code | Name | LCD Display | Parameter Setting | Setting Range | Unit |
|-------|------|---------------------|-------------|-------------------|---------------|------|
| Dr | 90 | [ESC] key functions | - | 1 | JOG Key | - |
| | 06 | Command source | Cmd Source* | 0 | Keypad | - |

* Displayed under DRV-06 on the LCD keypad.

Set dr.90 to 1(JOG Key) and set the drv code in the Operation group to 0(Keypad). When the [ESC] key is pressed, the SET display light flashes and the jog operation is ready to start. Pressing the [RUN] key starts the operation and the inverter accelerates or decelerates to the designated jog frequency. Releasing the [RUN] key stops the jog operation. Set the Acc/Dec time for the jog operation frequency at dr.12 and dr.13.

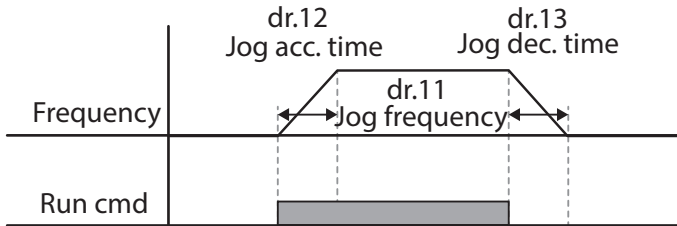

5.3 Up-down Operation

The Acc/Dec time can be controlled through input at the multi-function terminal block. Similar to a flowmeter, the up-down operation can be applied easily to a system that uses the upper-lower limit switch signals for Acc/Dec commands.

| Group | Code | Name | LCD Display | Parameter Setting | | Setting Range | Unit |
|-------|-------|----------------------------------|----------------------|-------------------|-----------|---------------|------|
| Ad | 65 | Up-down operation frequency save | U/D Save Mode | 1 | Yes | 0-1 | - |
| In | 65-71 | Px terminal configuration | Px Define(Px: P1-P7) | 17 | Up | - | - |
| | | | | 18 | Down | | |
| | | | | 20 | U/D Clear | | |

Up-down Operation Setting Details

| Code | Description |
|--------------------|--|
| In.65-71 Px Define | <p>Select two terminals for up-down operation and set them to 17 (Up) and 18 (Down), respectively. With the operation command input, acceleration begins when the Up terminal signal is on. Acceleration stops and constant speed operation begins when the signal is off.</p> <p>During operation, deceleration begins when the Down signal is on. Deceleration stops and constant speed operation begins when both Up and Down signals are entered at the same time.</p> |

| Code | Description |
|---------------------|---|
| | |
| Ad.65 U/D Save Mode | <p>During a constant speed operation, the operating frequency is saved automatically in the following conditions: the operation command (Fx or Rx) is off, a fault trip occurs, or the power is off.</p> <p>When the operation command is turned on again, or when the inverter regains the power source or resumes to a normal operation from a fault trip, it resumes operation at the saved frequency. To delete the saved frequency, use the multi-function terminal block. Set one of the multi-function terminals to 20 (U/D Clear) and apply signals to it during constant speed operation. The saved frequency and the up-down operation configuration will be deleted.</p> |

5.4 3-Wire Operation

The 3-wire operation latches the signal input (the signal stays on after the button is released), and is used when operating the inverter with a push button.

| Group | Code | Name | LCD Display | Parameter Setting | Setting Range | Unit |
|-----------|-------|---------------------------|----------------------|-------------------|---------------|------|
| Operation | drv | Command source | Cmd Source* | 1 | Fx/Rx - 1 | - |
| In | 65-71 | Px terminal configuration | Px Define(Px: P1-P5) | 14 | 3-Wire | - |

* Displayed under DRV-06 in an LCD keypad.

To enable the 3-wire operation, the following circuit sequence is necessary. The minimum input time (t) for 3-wire operation is 1ms, and the operation stops when both forward and reverse operation commands are entered at the same time.

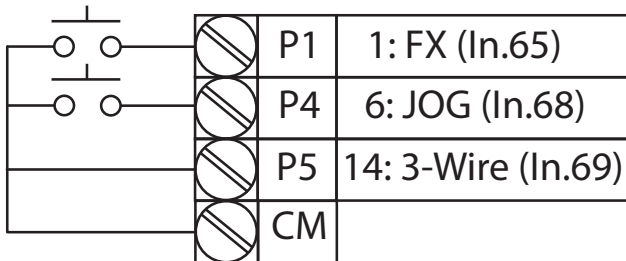

[Terminal connections for 3-wire operation]

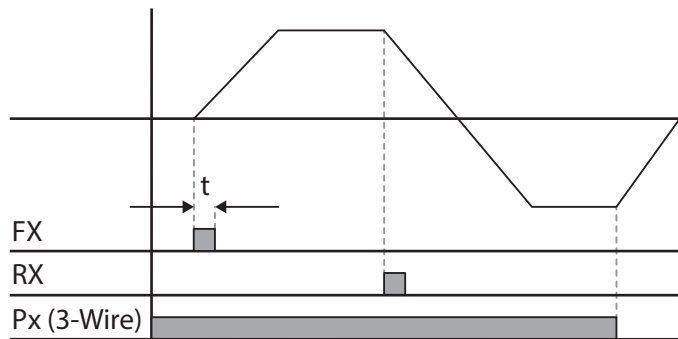

[3-wire operation]

5.5 Safe Operation Mode

When the multi-function terminals are configured to operate in safe mode, operation commands can be entered in the Safe operation mode only. Safe operation mode is used to safely and carefully control the inverter through the multi-function terminals.

| Group | Code | Name | LCD Display | Parameter Setting | Setting Range | Unit |
|-------|-------|----------------------------------|----------------------|-------------------|---------------|-----------|
| Ad | 70 | Safe operation selection | Run En Mode | 1 | DI Dependent | - |
| | 71 | Safe operation stop mode | Run Dis Stop | 0 | Free-Run | 0-2 |
| | 72 | Safe operation deceleration time | Q-Stop Time | 5.0 | | 0.0-600.0 |
| In | 65-69 | Px terminal configuration | Px Define(Px: P1-P5) | 13 | RUN Enable | - |

Safe Operation Mode Setting Details

| Code | Description | | |
|--------------------|---|--|--|
| In.65–69 Px Define | From the multi-function terminals, select a terminal to operate in safe operation mode and set it to 13 (RUN Enable). | | |
| Ad.70 Run En Mode | Setting | | |
| | 0 | Always Enable | Enables safe operation mode. |
| | 1 | DI Dependent | Recognizes the operation command from a multi-function input terminal. |
| Ad.71 Run Dis Stop | Set the operation of the inverter when the multi-function input terminal in safe operation mode is off. | | |
| | Setting | | |
| | 1 | Free-Run | Blocks the inverter output when the multi-function terminal is off. |
| | 2 | Q-Stop | The deceleration time (Q-Stop Time) used in safe operation mode. It stops after deceleration and then the operation can resume only when the operation command is entered again. The operation will not begin if only the multi-function terminal is on. |
| 3 | Q-Stop Resume | The inverter decelerates to the deceleration time (Q-Stop Time) in safe operation mode. It stops after deceleration. Then if the multi-function terminal is on, the operation resumes as soon as the operation command is entered again. | |
| Ad.72 Q-Stop Time | Sets the deceleration time when Ad.71 (Run Dis Stop) is set to 1 (Q-Stop) or 2 (Q-Stop Resume). | | |

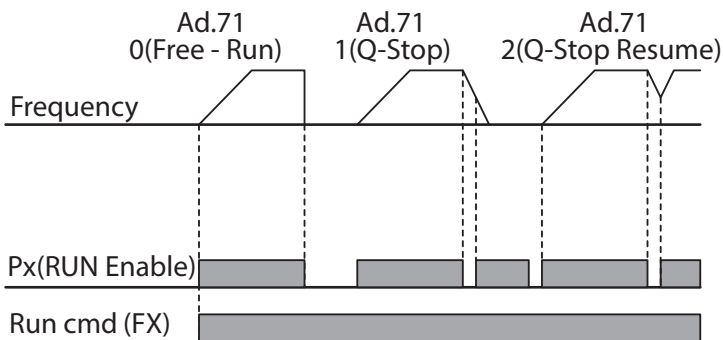

5.6 Dwell Operation

The dwell operation is used to maintain torque during the application and release of the brakes on lift-type loads. Inverter dwell operation is based on the Acc/Dec dwell frequency and the dwell time set by the user. The following points also affect dwell operation:

- **Acceleration Dwell Operation:** When an operation command runs, acceleration continues until the acceleration dwell frequency and constant speed is reached within the acceleration dwell operation time (Acc Dwell Time). After the Acc Dwell Time has passed, acceleration is carried out based on the acceleration time and the operation speed that was originally set.
- **Deceleration Dwell Operation:** When a stop command is run, deceleration continues until the deceleration dwell frequency and constant speed is reached within the deceleration dwell operation time (Dec Dwell Freq). After the set time has passed, deceleration is carried out based on the deceleration time that was originally set, then the operation stops.

When dr.09 (Control Mode) is set to 0 (V/F), the inverter can be used for operations with dwell frequency before opening the mechanical brake of lift-type loads, such as an elevator.

| Group | Code | Name | LCD Display | Parameter Setting | Setting Range | Unit |
|-------|------|-------------------------------------|----------------|-------------------|-------------------------------------|------|
| Ad | 20 | Dwell frequency during acceleration | Acc Dwell Freq | 5.00 | Start frequency – Maximum frequency | Hz |
| | 21 | Operation time during acceleration | Acc Dwell Time | 0.0 | 0.0–10.0 | s |
| | 22 | Dwell frequency during deceleration | Dec Dwell Freq | 5.00 | Start frequency – Maximum frequency | Hz |
| | 23 | Operation time during deceleration | Dec Dwell Time | 0.0 | 0.0-60.0 | s |

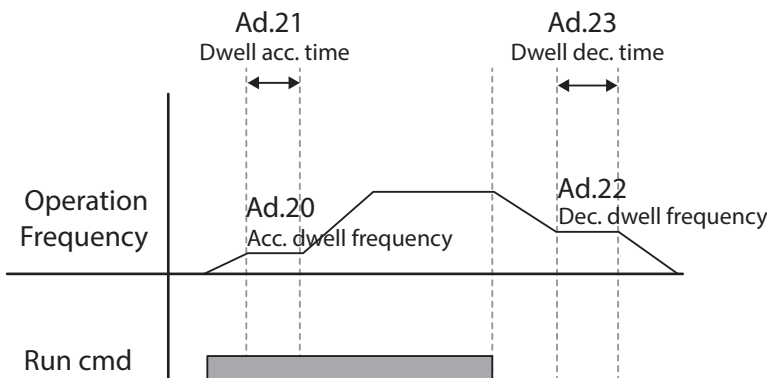

Note

Dwell operation does not work when:

- Dwell operation time is set to 0 sec or dwell frequency is set to 0 Hz.
- Re-acceleration is attempted from stop or during deceleration, as only the first acceleration dwell operation command is valid.

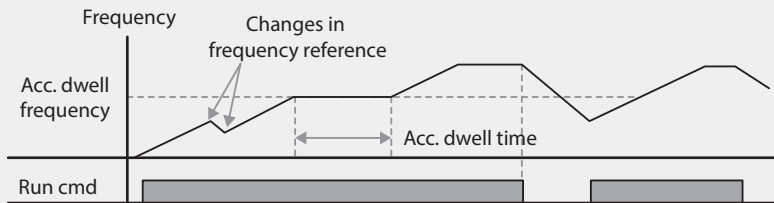

[Acceleration dwell operation]

Although deceleration dwell operation is carried out whenever stop commands are entered and the deceleration dwell frequency is passed through, it does not work during a deceleration by simple frequency change (which is not a deceleration due to a stop operation), or during external brake control applications.

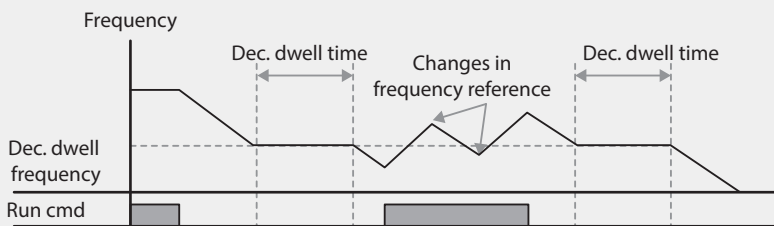

[Deceleration dwell operation]

⚠ Caution

When a dwell operation is carried out for a lift - type load before its mechanical brake is released, motors can be damaged or their lifecycle reduced due to overflow current in the motor.

5.7 Slip Compensation Operation

Slip refers to the variation between the setting frequency (synchronous speed) and motor rotation speed. As the load increases there can be variations between the setting frequency and motor rotation speed. Slip compensation is used for loads that require compensation of these speed variations.

| Group | Code | Name | LCD Display | Parameter Setting | Setting Range | Unit |
|-------|------|-----------------------|----------------|--------------------------|---------------|------|
| dr | 09 | Control mode | Control Mode | 2 Slip Compen | - | - |
| | 14 | Motor capacity | Motor Capacity | 2 0.75 kW (0.75kW based) | 0-15 | - |
| bA | 11 | Number of motor poles | Pole Number | 4 | 2-48 | - |
| | 12 | Rated slip speed | Rated Slip | 90 (0.75kW based) | 0-3000 | rpm |
| | 13 | Rated motor current | Rated Curr | 3.6 (0.75kW based) | 1.0-1000.0 | A |
| | 14 | Motor no-load current | Noload Curr | 1.6 (0.75kW based) | 0.5-1000.0 | A |
| | 16 | Motor efficiency | Efficiency | 72 (0.75kW based) | 70-100 | % |
| | 17 | Load inertia rate | Inertia Rate | 0 (0.75kW based) | 0-8 | - |

Slip Compensation Operation Setting Details

| Code | Description | | | | | | | | |
|----------------------|--|---------|----------|---|----------------------------------|---|------------------------|-----|----------------------------------|
| dr.09 Control Mode | Set dr.09 to 2 (Slip Compen) to carry out the slip compensation operation. | | | | | | | | |
| dr.14 Motor Capacity | Set the capacity of the motor connected to the inverter. | | | | | | | | |
| bA.11 Pole Number | Enter the number of poles from the motor rating plate. | | | | | | | | |
| bA.12 Rated Slip | Enter the number of rated rotations from the motor rating plate. | | | | | | | | |
| bA.13 Rated Curr | Enter the rated current from the motor rating plate. | | | | | | | | |
| bA.14 Noload Curr | Enter the measured current when the load on the motor axis is removed and when the motor is operated at the rated frequency. If no-load current is difficult to measure, enter a current equivalent to 30-50% of the rated motor current. | | | | | | | | |
| bA.16 Efficiency | Enter the efficiency from the motor rating place. | | | | | | | | |
| bA.17 Inertia Rate | Select load inertia based on motor inertia. <table border="1" style="margin-left: 20px;"> <thead> <tr> <th>Setting</th> <th>Function</th> </tr> </thead> <tbody> <tr> <td>0</td> <td>Less than 10 times motor inertia</td> </tr> <tr> <td>1</td> <td>10 times motor inertia</td> </tr> <tr> <td>2-8</td> <td>More than 10 times motor inertia</td> </tr> </tbody> </table> $f_s = f_r - \frac{Rpm \times P}{120}$ <p> f_s=Rated slip frequency f_r=Rated frequency rpm=Number of the rated motor rotations P=Number of motor poles </p> | Setting | Function | 0 | Less than 10 times motor inertia | 1 | 10 times motor inertia | 2-8 | More than 10 times motor inertia |
| Setting | Function | | | | | | | | |
| 0 | Less than 10 times motor inertia | | | | | | | | |
| 1 | 10 times motor inertia | | | | | | | | |
| 2-8 | More than 10 times motor inertia | | | | | | | | |

Motor Rotation

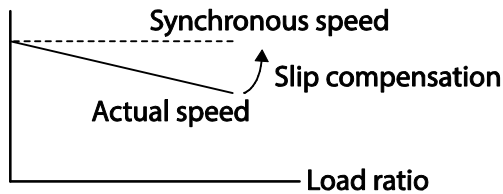

5.8 PID Control

Pid control is one of the most common auto-control methods. It uses a combination of proportional, integral, and differential (PID) control that provides more effective control for automated systems. The functions of PID control that can be applied to the inverter operation are as follows:

| Purpose | Function |
|---------------------|---|
| Speed control | Controls speed by using feedback about the existing speed level of the equipment or machinery to be controlled. Control maintains consistent speed or operates at the target speed. |
| Pressure control | Controls pressure by using feedback about the existing pressure level of the equipment or machinery to be controlled. Control maintains consistent pressure or operates at the target pressure. |
| Flow control | Controls flow by using feedback about the amount of existing flow in the equipment or machinery to be controlled. Control maintains consistent flow or operates at a target flow. |
| Temperature control | Controls temperature by using feedback about the existing temperature level of the equipment or machinery to be controlled. Control maintains a consistent temperature or operates at a target temperature. |

5.8.1 PID Basic Operation

PID operates by controlling the output frequency of the inverter, through automated system process control to maintain speed, pressure, flow, temperature and tension.

| Group | Code | Name | LCD Display | Parameter Setting | Setting Range | Unit |
|-------|------|--------------------------------|---------------|-------------------|---------------|------|
| AP | 01 | Application function selection | App Mode | 2 Proc PID | 0-2 | - |
| | 16 | PID output monitor | PID Output | - | - | - |
| | 17 | PID reference monitor | PID Ref Value | - | - | - |
| | 18 | PID feedback monitor | PID Fdb Value | - | - | - |

| Group | Code | Name | LCD Display | Parameter Setting | | Setting Range | Unit |
|-------|-------|---|-----------------------|-------------------|--------------|---------------------|------|
| | 19 | PID reference setting | PID Ref Set | 50.00 | | -100.00-100.00 | % |
| | 20 | PID reference source | PID Ref Source | 0 | Keypad | 0-11 | - |
| | 21 | PID feedback source | PID F/B Source | 0 | V1 | 0-10 | - |
| | 22 | PID controller proportional gain | PID P-Gain | 50.0 | | 0.0-1000.0 | % |
| | 23 | PID controller integral time | PID I-Time | 10.0 | | 0.0-200.0 | sec |
| | 24 | PID controller differential time | PID D-Time | 0 | | 0-1000 | msec |
| | 25 | PID controller feed-forward compensation gain | PID F-Gain | 0.0 | | 0-1000 | % |
| | 26 | Proportional gain scale | P Gain Scale | 100.0 | | 0.0-100.0 | % |
| | 27 | PID output filter | PID Out LPF | 0 | | 0-10000 | ms |
| | 29 | PID maximum frequency | PID Limit Hi | 60.00 | | -300.00-300.00 | Hz |
| | 30 | PID minimum frequency | PID Limit Lo | 0.5 | | -300.00-300.00 | Hz |
| | 31 | PID output reverse | PID Out Inv | 0 | No | 0-1 | - |
| | 32 | PID output scale | PID Out Scale | 100.0 | | 0.1-1000.0 | % |
| | 34 | PID controller motion frequency | Pre-PID Freq | 0.00 | | 0-Maximum frequency | Hz |
| | 35 | PID controller motion level | Pre-PID Exit | 0.0 | | 0.0-100.0 | % |
| | 36 | PID controller motion delay time | Pre-PID Delay | 600 | | 0-9999 | sec |
| | 37 | PID sleep mode delay time | PID Sleep DT | 60.0 | | 0-999.9 | sec |
| | 38 | PID sleep mode frequency | PID Sleep Freq | 0.00 | | 0-Maximum frequency | Hz |
| | 39 | PID wake-up level | PID WakeUp Lev | 35 | | 0-100 | % |
| | 40 | PID wake-up mode selection | PID WakeUp Mod | 0 | Below Level | 0-2 | - |
| | 42 | PID controller unit selection | PID Unit Sel | 0 | % | 0-12 | - |
| | 43 | PID unit gain | PID Unit Gain | 100.0 | | 0-300 | % |
| | 44 | PID unit scale | PID Unit Scale | 2 | x 1 | 0-4 | - |
| | 45 | PID 2 nd proportional gain | PID P2-Gain | 100.00 | | 0-1000 | % |
| In | 65-71 | Px terminal configuration | Px Define (Px: P1-P7) | 22 | I-Term Clear | - | - |
| | | | | 23 | PID Openloop | | |
| | | | | 24 | P Gain2 | | |

PID Basic Operation Setting Details

| Code | Description | | | | | | | | | | | | | | | | | | |
|--------------------------------------|---|---------|----------|---|--------|---|----|---|----|---|----|---|----------|---|----------|---|-------------|----|-------|
| AP.01 App Mode | Set the code to 2 (Proc PID) to select functions for the process PID. | | | | | | | | | | | | | | | | | | |
| AP.16 PID Output | Displays the existing output value of the PID controller. The unit, gain, and scale that were set at AP. 42-44 are applied on the display. | | | | | | | | | | | | | | | | | | |
| AP.17 PID Ref Value | Displays the existing reference value set for the PID controller. The unit, gain, and scale that were set at AP. 42-44 are applied on the display. | | | | | | | | | | | | | | | | | | |
| AP.18 PID Fdb Value | Displays the input value of the PID controller that is included in the latest feedback. The unit, gain, and scale that were set at AP. 42-44 are applied on the display. | | | | | | | | | | | | | | | | | | |
| AP.19 PID Ref Set | When AP.20 (PID control reference source) is set to 0 (Keypad), the reference value can be entered. If the reference source is set to any other value, the setting values for AP.19 are void. | | | | | | | | | | | | | | | | | | |
| AP.20 PID Ref Source | <p>Selects the reference input for the PID control. If the V1 terminal is set to PID feedback source (PID F/B Source), the V1 terminal cannot be set to the PID reference source (PID Ref Source). To set V1 as a reference source, change the feedback source.</p> <table border="1"> <thead> <tr> <th>Setting</th> <th>Function</th> </tr> </thead> <tbody> <tr> <td>0</td> <td>Keypad</td> </tr> <tr> <td>1</td> <td>V1</td> </tr> <tr> <td>3</td> <td>V2</td> </tr> <tr> <td>4</td> <td>I2</td> </tr> <tr> <td>5</td> <td>Int. 485</td> </tr> <tr> <td>7</td> <td>FieldBus</td> </tr> <tr> <td>9</td> <td>UserSeqLink</td> </tr> <tr> <td>11</td> <td>Pulse</td> </tr> </tbody> </table> <p>When using the keypad, the PID reference setting can be displayed at AP.17. When using the LDC keypad, the PID reference setting can be monitored from</p> | Setting | Function | 0 | Keypad | 1 | V1 | 3 | V2 | 4 | I2 | 5 | Int. 485 | 7 | FieldBus | 9 | UserSeqLink | 11 | Pulse |
| Setting | Function | | | | | | | | | | | | | | | | | | |
| 0 | Keypad | | | | | | | | | | | | | | | | | | |
| 1 | V1 | | | | | | | | | | | | | | | | | | |
| 3 | V2 | | | | | | | | | | | | | | | | | | |
| 4 | I2 | | | | | | | | | | | | | | | | | | |
| 5 | Int. 485 | | | | | | | | | | | | | | | | | | |
| 7 | FieldBus | | | | | | | | | | | | | | | | | | |
| 9 | UserSeqLink | | | | | | | | | | | | | | | | | | |
| 11 | Pulse | | | | | | | | | | | | | | | | | | |
| AP.21 PID F/B Source | <p>Selects feedback input for PID control. Items can be selected as reference input, except the keypad input (Keypad-1 and Keypad-2). Feedback cannot be set to an input item that is identical to the item selected as the reference. For example, when Ap.20 (Ref Source) is set to 1 (V1), for AP. 21 (PID F/B Source), an input other than the V1 terminal must be selected. When using the LCD keypad, the volume of feedback can be monitored using a code from the config mode (CNF) -06-08, by setting it to 18 (PID Fbk Value).</p> | | | | | | | | | | | | | | | | | | |
| AP.22 PID P-Gain, AP.26 P Gain Scale | <p>Sets the output ratio for differences (errors) between reference and feedback. If the Pgain is set to 50%, then 50% of the error is output. The setting range for Pgain is 0.0-1,000%. For ratios below 0.1%, use AP.26 (P Gain Scale).</p> | | | | | | | | | | | | | | | | | | |

| Code | Description | | | | | | | | | | | | | | | | | | | | |
|--|---|---------|----------|-------|--|---------|--|----------|--------|---------|--------|---|---------|---|-------|-------|--------|---------|---------|------------------------------------|---------|
| AP.23 PID I-Time | Sets the time to output accumulated errors. When the error is 100%, the time taken for 100% output is set. When the integral time (PID I-Time) is set to 1 second, 100% output occurs after 1 second of the error remaining at 100%. Differences in a normal state can be reduced by PID I Time. When the multi-function terminal block is set to 21(I-Term Clear) and is turned on, all of the accumulated errors are deleted. | | | | | | | | | | | | | | | | | | | | |
| AP.24 PID D-Time | Sets the output volume for the rate of change in errors. If the differential time (PID D-Time) is set to 1ms and the rate of change in errors per sec is 100%, output occurs at 1% per 10ms. | | | | | | | | | | | | | | | | | | | | |
| AP.25 PID F-Gain | Sets the ratio that adds the target to the PID output. Adjusting this value leads to a faster response. | | | | | | | | | | | | | | | | | | | | |
| AP.27 PID Out LPF | Used when the output of the PID controller changes too fast or the entire system is unstable, due to severe oscillation. In general, a lower value (default value=0) is used to speed up response time, but in some cases a higher value increases stability. The higher the value, the more stable the PID controller output is, but the slower the response time. | | | | | | | | | | | | | | | | | | | | |
| AP.29 PID Limit Hi, AP.30 PID Limit Lo | Limits the output of the controller. | | | | | | | | | | | | | | | | | | | | |
| AP.32 PID Out Scale | Adjusts the volume of the controller output. | | | | | | | | | | | | | | | | | | | | |
| AP.42 PID Unit Sel | Sets the unit of the control variable (available only on the LCD keypad). <table border="1" data-bbox="381 973 1236 1466"> <thead> <tr> <th>Setting</th> <th>Function</th> </tr> </thead> <tbody> <tr> <td>0 %</td> <td>Displays a percentage without a physical quantity given.</td> </tr> <tr> <td>1 Bar</td> <td rowspan="4">Various units of pressure can be selected.</td> </tr> <tr> <td>2 mBar</td> </tr> <tr> <td>3 Pa</td> </tr> <tr> <td>4 kPa</td> </tr> <tr> <td>5 Hz</td> <td>Displays the inverter output frequency or the motor rotation speed.</td> </tr> <tr> <td>6 rpm</td> <td rowspan="5">Displays in voltage/current/power/horsepower.</td> </tr> <tr> <td>7 V</td> </tr> <tr> <td>8 I</td> </tr> <tr> <td>9 kW</td> </tr> <tr> <td>10 HP</td> </tr> <tr> <td>11 °C</td> <td rowspan="2">Displays in Celsius or Fahrenheit.</td> </tr> <tr> <td>12 °F</td> </tr> </tbody> </table> | Setting | Function | 0 % | Displays a percentage without a physical quantity given. | 1 Bar | Various units of pressure can be selected. | 2 mBar | 3 Pa | 4 kPa | 5 Hz | Displays the inverter output frequency or the motor rotation speed. | 6 rpm | Displays in voltage/current/power/horsepower. | 7 V | 8 I | 9 kW | 10 HP | 11 °C | Displays in Celsius or Fahrenheit. | 12 °F |
| Setting | Function | | | | | | | | | | | | | | | | | | | | |
| 0 % | Displays a percentage without a physical quantity given. | | | | | | | | | | | | | | | | | | | | |
| 1 Bar | Various units of pressure can be selected. | | | | | | | | | | | | | | | | | | | | |
| 2 mBar | | | | | | | | | | | | | | | | | | | | | |
| 3 Pa | | | | | | | | | | | | | | | | | | | | | |
| 4 kPa | | | | | | | | | | | | | | | | | | | | | |
| 5 Hz | Displays the inverter output frequency or the motor rotation speed. | | | | | | | | | | | | | | | | | | | | |
| 6 rpm | Displays in voltage/current/power/horsepower. | | | | | | | | | | | | | | | | | | | | |
| 7 V | | | | | | | | | | | | | | | | | | | | | |
| 8 I | | | | | | | | | | | | | | | | | | | | | |
| 9 kW | | | | | | | | | | | | | | | | | | | | | |
| 10 HP | | | | | | | | | | | | | | | | | | | | | |
| 11 °C | Displays in Celsius or Fahrenheit. | | | | | | | | | | | | | | | | | | | | |
| 12 °F | | | | | | | | | | | | | | | | | | | | | |
| AP.43 PID Unit Gain, AP.44 PID Unit Scale | Adjusts the size to fit the unit selected at AP.41 PID Unit Sel. | | | | | | | | | | | | | | | | | | | | |
| AP.45 PID P2-Gain | The PID controller's gain can be adjusted using the multi-function terminal. When a terminal is selected from In.65-71 and set to 24 (P Gain2), and if the selected terminal is entered, the gain set in AP.22 and AP.23 can be switched to the gain set in AP.45. | | | | | | | | | | | | | | | | | | | | |

Note

When the PID switch operation (switching from PID operation to general operation) enters the multi-function input, [%] values are converted to [Hz] values. The normal PID output, PID OUT, is unipolar, and is limited by AP.29 (PID Limit Hi) and AP.30 (PID Limit Lo). A calculation of 100.0% is based on the dr.20 (Max Freq) parameter setting.

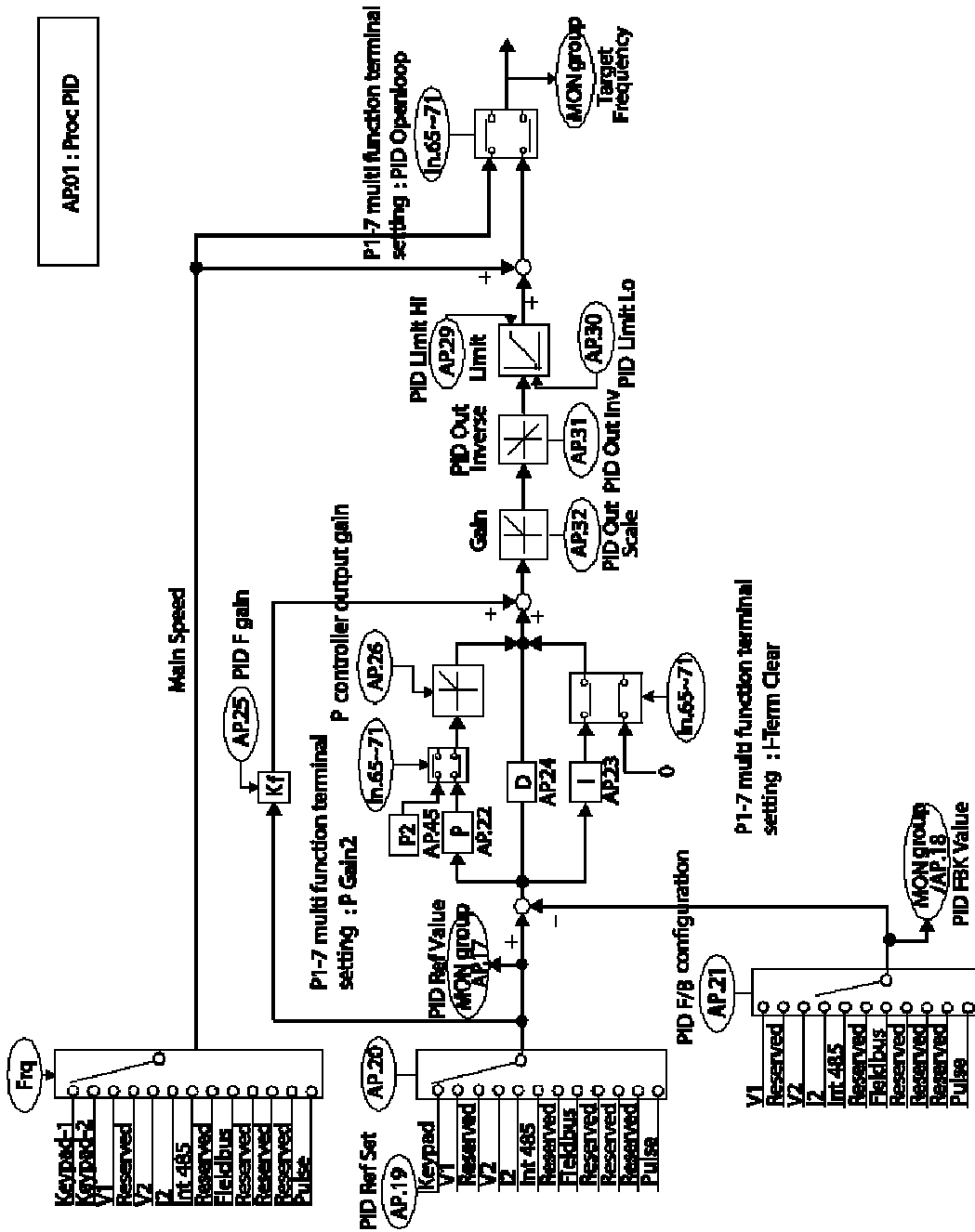

[PID control block diagram]

5.8.2 Pre-PID Operation

When an operation command is entered that does not include PID control, general acceleration occurs until the set frequency is reached. When the controlled variables increase to a particular point, the PID operation begins.

Pre-PID Operation Setting Details

| Code | Description |
|---|---|
| AP.34 Pre-PID Freq | When general acceleration is required, the frequency up to general acceleration is entered. If Pre-PID Freq is set to 30Hz, the general operation continues until the control variable (PID feedback variable) set at AP. 35 is exceeded. |
| AP.35 Pre-PID Exit, AP.36 Pre-PID Delay | When the feedback variable of the PID controller is higher than the value set at AP. 35, the PID control operation begins. However, when a value is set for AP.36 (Pre-PID Delay) and a feedback variable less than the value set at AP.35 is maintained for a set amount of time, the “pre-PID Fail” fault trip will occur and the output will be blocked. |

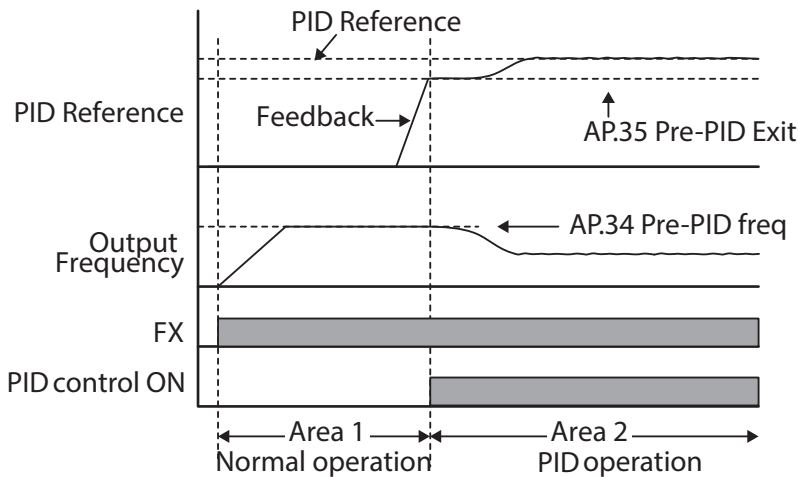

5.8.3 PID Operation Sleep Mode

If the operation continues at a frequency lower than the set condition for PID operation, the PID operation sleep mode starts. When PID operation sleep mode starts, the operation will stop until the feedback exceeds the parameter value set at AP.39 (PID WakeUp Lev).

PID Operation Sleep Mode Setting Details

| Code | Description |
|---|---|
| AP.37 PID Sleep DT, AP.38 PID Sleep Freq | If an operation frequency lower than the value set at AP.38 is maintained for the time set at AP.37, the operation stops and the PID operation sleep mode starts. |
| AP.39 PID WakeUp Lev, AP.40 PID WakeUp Mod | Starts the PID operation when in PID operation sleep mode. If AP. 40 is set to 0 (Below Level), the PID operation starts when the feedback variable is less than the value set as the AP. 39 parameter setting. If AP. 40 is set to 1 (Above Level), the operation starts when the feedback variable is higher than the value set at AP. 39. If AP. 40 is set to 2 (Beyond Level), the operation starts when the difference between the reference value and the feedback variable is greater than the value set at AP. 39. |

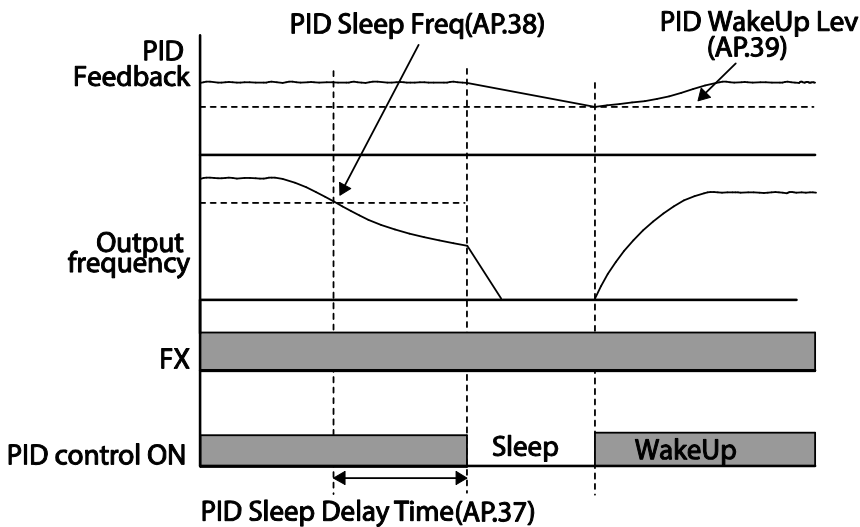

5.8.4 PID Switching (PID Openloop)

When one of the multi-function terminals (In. 65-71) is set to 23 (PID Openloop) and is turned on, the PID operation stops and is switched to general operation. When the terminal turns off, the PID operation starts again.

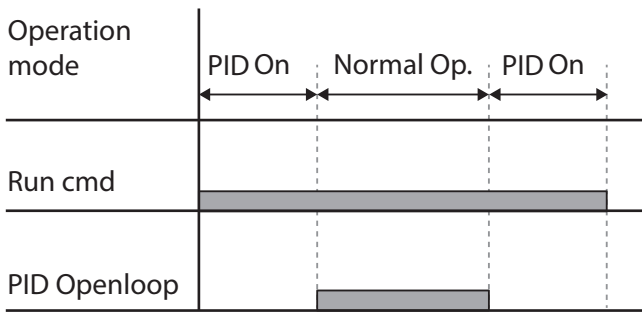

5.9 Auto Tuning

The motor parameters can be measured automatically and can be used for auto torque boost or sensorless vector control.

Example - Auto Tuning Based on 0.75kW, 200V Motor

| Group | Code | Name | LCD Display | Parameter Setting | Setting Range | Unit |
|-------|---------------------|-----------------------|----------------|-------------------|------------------------------|----------|
| dr | 14 | Motor capacity | Motor Capacity | 1 0.75 kW | 0-15 | - |
| bA | 11 | Motor pole number | Pole Number | 4 | 2-48 | - |
| | 12 | Rated slip speed | Rated Slip | 40 | 0-3000 | rpm |
| | 13 | Rated motor current | Rated Curr | 3.6 | 1.0-1000.0 | A |
| | 14 | Motor no-load current | Noload curr | 1.6 | 0.5-1000.0 | A |
| | 15 | Motor rated voltage | Rated Volt | 220 | 170-480 | V |
| | 16 | Motor efficiency | Efficiency | 72 | 70-100 | % |
| | 20 | Auto tuning | Auto Tuning | 0 None | - | - |
| | 21 | Stator resistance | Rs | 26.00 | Depends on the motor setting | Ω |
| | 22 | Leakage inductance | Lsigma | 179.4 | Depends on the motor setting | mH |
| | 23 | Stator inductance | Ls | 1544 | Depends on the motor setting | mH |
| 24 | Rotor time constant | Tr | 145 | 25-5000 | ms | |

Auto Tuning Default Parameter Setting

| Motor Capacity (kW) | Rated Current (A) | No-load Current (A) | Rated Slip Frequency(Hz) | Stator Resistance(Ω) | Leakage Inductance (mH) | |
|---------------------|-------------------|---------------------|--------------------------|-------------------------------|-------------------------|-------|
| 200V | 0.2 | 1.1 | 0.8 | 3.33 | 14.0 | 40.4 |
| | 0.4 | 2.4 | 1.4 | 3.33 | 6.70 | 26.9 |
| | 0.75 | 3.4 | 1.7 | 3.00 | 2.600 | 17.94 |
| | 1.5 | 6.4 | 2.6 | 2.67 | 1.170 | 9.29 |
| | 2.2 | 8.6 | 3.3 | 2.33 | 0.840 | 6.63 |
| | 3.7 | 13.8 | 5.0 | 2.33 | 0.500 | 4.48 |
| | 5.5 | 21.0 | 7.1 | 1.50 | 0.314 | 3.19 |
| | 7.5 | 28.2 | 9.3 | 1.33 | 0.169 | 2.844 |
| | 11 | 40.0 | 12.4 | 1.00 | 0.120 | 1.488 |
| | 15 | 53.6 | 15.5 | 1.00 | 0.084 | 1.118 |
| | 18.5 | 65.6 | 19.0 | 1.00 | 0.068 | 0.819 |
| | 22 | 76.8 | 21.5 | 1.00 | 0.056 | 0.948 |
| 400V | 0.2 | 0.7 | 0.5 | 3.33 | 28.00 | 121.2 |
| | 0.4 | 1.4 | 0.8 | 3.33 | 14.0 | 80.8 |
| | 0.75 | 2.0 | 1.0 | 3.00 | 7.81 | 53.9 |
| | 1.5 | 3.7 | 1.5 | 2.67 | 3.52 | 27.9 |
| | 2.2 | 5.0 | 1.9 | 2.33 | 2.520 | 19.95 |
| | 3.7 | 8.0 | 2.9 | 2.33 | 1.500 | 13.45 |
| | 5.5 | 12.1 | 4.1 | 1.50 | 0.940 | 9.62 |
| | 7.5 | 16.3 | 5.4 | 1.33 | 0.520 | 8.53 |
| | 11 | 23.2 | 7.2 | 1.00 | 0.360 | 4.48 |
| | 15 | 31.0 | 9.0 | 1.00 | 0.250 | 3.38 |
| | 18.5 | 38.0 | 11.0 | 1.00 | 0.168 | 2.457 |
| | 22 | 44.5 | 12.5 | 1.00 | 0.168 | 2.844 |

Auto Tuning Parameter Setting Details

| Code | Description | | | | | | |
|-------------------|--|----------|----------|---|---|---|--|
| bA.20 Auto Tuning | Select an auto tuning type and run it. Select one of the options and then press the [ENT] key to run the auto tuning. | | | | | | |
| | <table border="1"> <thead> <tr> <th>Setting</th> <th>Function</th> </tr> </thead> <tbody> <tr> <td>0</td> <td>None Auto tuning function is not enabled. Also, if you select one of the auto tuning options and run it, the parameter value will revert back to "0" when the auto tuning is complete.</td> </tr> <tr> <td>1</td> <td>All (rotating type) Measures all motor parameters, including stator resistance (Rs), stator inductance (Lsigma), no-load current (Noload Curr), rotor time constant (Tr), etc., while the motor is rotating. As the motor is rotating while the</td> </tr> </tbody> </table> | Setting | Function | 0 | None Auto tuning function is not enabled. Also, if you select one of the auto tuning options and run it, the parameter value will revert back to "0" when the auto tuning is complete. | 1 | All (rotating type) Measures all motor parameters, including stator resistance (Rs), stator inductance (Lsigma), no-load current (Noload Curr), rotor time constant (Tr), etc., while the motor is rotating. As the motor is rotating while the |
| | Setting | Function | | | | | |
| 0 | None Auto tuning function is not enabled. Also, if you select one of the auto tuning options and run it, the parameter value will revert back to "0" when the auto tuning is complete. | | | | | | |
| 1 | All (rotating type) Measures all motor parameters, including stator resistance (Rs), stator inductance (Lsigma), no-load current (Noload Curr), rotor time constant (Tr), etc., while the motor is rotating. As the motor is rotating while the | | | | | | |

| Code | Description | |
|--------------------------------------|---|---|
| | | parameters are being measured, if the load is connected to the motor spindle, the parameters may not be measured accurately. For accurate measurements, remove the load attached to the motor spindle. However, note that the rotor time constant (Tr) must be measured in a stopped position. |
| | 2 | All (static type) Measures all parameters while the motor is in the stopped position. Measures stator resistance (Rs), stator inductance (Lsigma), no-load current (Noload Curr), rotor time constant (Tr), etc., while the motor is in the stopped position. As the motor is not rotating while the parameters are measured, the measurements are not affected when the load is connected to the motor spindle. However, when measuring parameters, do not rotate the motor spindle on the load side. |
| | 3 | Rs+Lsigma (rotating type) Measures parameters while the motor is rotating. The measured motor parameters are used for auto torque boost or sensorless vector control. |
| | 6 | Tr (static type) Measures the rotor time constant (Tr) with the motor in the stopped position and Control Mode (dr.09) is set to IM Sensorless. |
| bA.14 Noload Curr, bA.21 Rs–bA.24 Tr | Displays motor parameters measured by auto tuning. For parameters that are not included in the auto tuning measurement list, the default setting will be displayed. | |

⚠ Caution

- Perform auto tuning ONLY after the motor has completely stopped running.
- Before you run auto tuning, check the motor pole number, rated slip, rated current, rated voltage and efficiency on the motor's rating plate and enter the data. The default parameter setting is used for values that are not entered.
- When measuring all parameters after selecting 2 (All - static type) at bA20: compared with rotation type auto tuning where parameters are measured while the motor is rotating, parameter values measured with static auto tuning may be less accurate. Inaccuracy of the measured parameters may degrade the performance of sensorless operation. Therefore, run static type auto tuning by selecting 2 (All) only when the motor cannot be rotated (when gearing and belts cannot be separated easily, or when the motor cannot be separated mechanically from the load).

5.10 Sensorless Vector Control

Sensorless vector control is an operation to carry out vector control without the rotation speed feedback from the motor but with an estimation of the motor rotation speed calculated by the inverter. Compared to V/F control, sensorless vector control can generate greater torque at a lower level of current.

| Group | Code | Name | LCD Display | Parameter Setting | Setting Range | Unit |
|-------|--------------------------------|---|-------------------------------|-------------------------------|---------------|------|
| dr | 09 | Control mode | Control Mode | 4 IM Sensorless | - | - |
| | 14 | Motor capacity | Motor Capacity | Depends on the motor capacity | 0-15 | - |
| | 18 | Base frequency | Base Freq | 60 | 30-400 | Hz |
| In | 11 | Motor pole number | Pole Number | 4 | 2-48 | - |
| | 12 | Rated slip speed | Rated Slip | Depends on the motor capacity | 0-3000 | Hz |
| | 13 | Rated motor current | Rated Curr | Depends on the motor capacity | 1-1000 | A |
| | 14 | Motor no-load current | Noload curr | Depends on the motor capacity | 0.5-1000 | A |
| | 15 | Rated motor voltage | Rated Volt | 220/380/440/480 | 170-480 | V |
| | 16 | Motor efficiency | Efficiency | Depends on the motor capacity | 70-100 | % |
| | 20 | Auto tuning | Auto Tuning | 1 All | - | - |
| Cn | 09 | Pre-Excite time | PreExTime | 1.0 | 0.0-60.0 | s |
| | 10 | Pre-Excite amount | Flux Force | 100.0 | 100.0-300.0 | % |
| | 20 | Sensorless second gain display setting | SL2 G View Sel | 1 Yes | 0-1 | - |
| | 21 | Sensorless speed controller proportional gain 1 | ASR-SL P Gain1 | Depends on the motor capacity | 0-5000 | % |
| | 22 | Sensorless speed controller integral gain 1 | ASR-SL I Gain1 | Depends on the motor capacity | 10-9999 | ms |
| | 23* | Sensorless speed controller proportional gain 2 | ASR-SL P Gain2 | Depends on the motor capacity | 1-1000 | % |
| | 24* | Sensorless speed controller integral gain 2 | ASR-SL I Gain2 | Depends on the motor capacity | 1-1000 | % |
| | 26* | Flux estimator proportional gain | Flux P Gain | Depends on the motor capacity | 10-200 | % |
| | 27* | Flux estimator integral gain | Flux I Gain | Depends on the motor capacity | 10-200 | % |
| | 28* | Speed estimator proportional gain | S-Est P Gain1 | Depends on the motor capacity | 0-32767 | - |
| 29* | Speed estimator integral gain1 | S-Est I Gain1 | Depends on the motor capacity | 100-1000 | - | |

Learning Advanced Features

| Group | Code | Name | LCD Display | Parameter Setting | Setting Range | Unit |
|-------|------|---|----------------|-------------------------------|---------------|------|
| | 30* | Speed estimator integral gain2 | S-Est I Gain2 | Depends on the motor capacity | 100-10000 | - |
| | 31* | Sensorless current controller proportional gain | ACR SL P Gain | 75 | 10-1000 | - |
| | 32* | Sensorless current controller integral gain | ACR SL I Gain | 120 | 10-1000 | - |
| | 52 | Torque controller output filter | Torque Out LPF | 0 | 0-2000 | ms |
| | 53 | Torque limit setting | Torque Lmt Src | 0 Keypad-1 | 0-12 | - |
| | 54 | Forward direction retrograde torque limit | FWD +Trq Lmt | 180.0 | 0.0-200.0 | % |
| | 55 | Forward direction regenerative torque limit | FWD -Trq Lmt | 180.0 | 0.0-200.0 | % |
| | 56 | Reverse direction retrograde torque limit | REV +Trq Lmt | 180.0 | 0.0-200.0 | % |
| | 57 | Reverse direction regenerative torque limit | REV -Trq Lmt | 180.0 | 0.0-200.0 | % |
| | 85* | Flux estimator proportional gain 1 | Flux P Gain1 | 370 | 100-700 | - |
| | 86* | Flux estimator proportional gain 2 | Flux P Gain2 | 0 | 0-100 | - |
| | 87* | Flux estimator proportional gain 3 | Flux P Gain3 | 100 | 0-500 | - |
| | 88* | Flux estimator integral gain 1 | Flux I Gain1 | 50 | 0-200 | - |
| | 89* | Flux estimator integral gain2 | Flux I Gain2 | 50 | 0-200 | - |
| | 90* | Flux estimator integral gain 3 | Flux I Gain3 | 50 | 0-200 | - |
| | 91* | Sensorless voltage compensation 1 | SL Volt Comp1 | 30 | 0-60 | - |
| | 92* | Sensorless voltage compensation 2 | SL Volt Comp2 | 20 | 0-60 | - |
| | 93* | Sensorless voltage compensation 3 | SL Volt Comp3 | 20 | 0-60 | - |
| | 94* | Sensorless field weakening start frequency | SL FW Freq | 95.0 | 80.0-110.0 | % |
| | 95* | Sensorless gain switching frequency | SL Fc Freq | 2.00 | 0.00-8.00 | Hz |

*Cn.23-32 and Cn.85-95 can be displayed only when Cn.20 is set to 1 (Yes).

⚠ Caution

For high-performance operation, the parameters of the motor connected to the inverter output must be measured. Use auto tuning (bA.20 Auto Tuning) to measure the parameters before you run sensorless vector operation. To run high-performance sensorless vector control, the inverter and the motor must have the same capacity. If the motor capacity is smaller than the inverter capacity by more than two levels, control may be inaccurate. In that case, change the control mode to V/F control. When operating with sensorless vector control, do not connect multiple motors to the inverter output.

5.10.1 Sensorless Vector Control Operation Setting

To run sensorless vector control operation, set dr.09 (Control Mode) to 4 (IM sensorless), select the capacity of the motor you will use at dr.14 (Motor Capacity), and select the appropriate codes to enter the rating plate information of the motor.

| Code | Input (Motor Rating Plate Information) |
|-------------------|---|
| drv.18 Base Freq | Base frequency |
| bA.11 Pole Number | Motor pole number |
| bA.12 Rated Slip | Rated slip |
| bA.13 Rated Curr | Rated current |
| bA.15 Rated Volt | Rated voltage |
| bA.16 Efficiency | Efficiency (when no information is on the rating plate, default values are used.) |

After setting each code, set bA.20 (Auto tuning) to 1 (All - rotation type) or 2 (All - static type) and run auto tuning. Because rotation type auto tuning is more accurate than static type auto tuning, select 1 (All - rotation type) and run auto tuning if you can rotate the motor.

Note**Excitation Current**

A motor can be operated only after magnetic flux is generated by current flowing through a coil. The power supply used to generate the magnetic flux is called the excitation current. The stator coil that is used with the inverter does not have a permanent magnetic flux, so the magnetic flux must be generated by supplying an excitation current to the coil before operating the motor.

Sensorless Vector Control Operation Setting Details

| Code | Description | |
|---|---|----------|
| Cn.20 SL2 G View Sel | Setting | Function |
| | 0 | No |
| | 1 | Yes |
| | <p>Does not display sensorless (II) vector control gain code.</p> <p>Allows the user to set various gains applied when the motor rotates faster than medium speed (approx. 1/2 of the base frequency) through sensorless (II) vector control.</p> <p>Codes available when setting to 1 (Yes): Cn.23 ASR-SL P Gain2/Cn.24 ASR-SL I Gain2/Cn.26 Flux P Gain/Cn.27 Flux I Gain Gain3/Cn.28 S-Est P Gain1/Cn.29 S-Est I Gain1/Cn.30 S-Est I Gain1/Cn.31 ACR SL P Gain/Cn.32 ACR SL I Gain</p> | |
| Cn.09 PreExTime | Sets pre-excitation time. Pre-excitation is used to start the operation after performing excitation up to the motor's rated flux. | |
| Cn.10 Flux Force | <p>Allows for the reduction of the pre-excitation time. The motor flux increases up to the rated flux with the time constant as shown in the following figure. To reduce the time taken to reach the rated flux, a higher motor flux base value than the rated flux must be provided. When the magnetic flux reaches the rated flux, the provided motor flux base value is reduced.</p> | |
| Cn.11 Hold Time | <p>Sets the zero-speed control time (hold time) in the stopped position. The output is blocked after zero-speed operation for a set period when the motor decelerates and is stopped by a stop command.</p> | |
| Cn.21 ASR-SL P Gain1, Cn.22 ASR-SL I Gain1 | Changes the speed PI controller gain during sensorless vector control. For a PI speed controller, P gain is a proportional gain for the speed deviation. If speed deviation becomes higher than the torque the output command | |

| Code | Description | | | | | | | | | | | | | | | | | | | | | | | | | |
|--|--|--|--|----------|---|----------|--|---|----------|--|---|----|---|---|----|---|----|---|---------|--|---|----------|---|---|-------------|--|
| | <p>increases accordingly. As the value increases, the faster the speed deviation decreases. The speed controller I gain is the integral gain for speed deviation. It is the time taken for the gain to reach the rated torque output command while a constant speed deviation continues. The lower the value becomes, the faster the speed deviation decreases.</p> | | | | | | | | | | | | | | | | | | | | | | | | | |
| <p>Cn.23 ASR-SL P Gain2, Cn.24 ASR-SL I Gain2</p> | <p>Appears only when 1 (Yes) is selected for Cn.20 (SL2 G view Sel). The speed controller gain can be increased to more than the medium speed for sensorless vector control. Cn.23 ASR-SL P Gain2 is set as a percentage of the low speed gain Cn.21 ASR-SL P Gain1 - if P Gain 2 is less than 100.0%, the responsiveness decreases. For example, if Cn.21 ASR-SL P Gain1 is 50.0% and Cn.23 ASR-SL P Gain2 is 50.0%, the actual middle speed or faster speed controller P gain is 25.0%.</p> <p>Cn.24 ASR-SL I Gain2 is also set as a percentage of the Cn.22 ASR-SL I Gain1. For I gain, the smaller the I gain 2 becomes, the slower the response time becomes. For example, if Cn.22 ASR-SL I Gain1 is 100ms and Cn.24 ASR-SL I Gain2 is 50.0%, the middle speed or faster speed controller I gain is 200 ms. The controller gain is set according to the default motor parameters and Acc/Dec time.</p> | | | | | | | | | | | | | | | | | | | | | | | | | |
| <p>Cn.26 Flux P Gain, Cn.27 Flux I Gain, Cn.85-87 Flux P Gain13, Cn.88-90 Flux I Gain1-3</p> | <p>Sensorless vector control requires the rotor flux estimator. For the adjustment of flux estimator gain, refer to 5.10.2 Sensorless Vector Control Operation Guide to on page 152.</p> | | | | | | | | | | | | | | | | | | | | | | | | | |
| <p>Cn.28 S-Est P Gain1, Cn.29 S-Est I Gain1, Cn.30 S-Est I Gain2</p> | <p>Speed estimator gain for sensorless vector control can be adjusted. To adjust speed estimator gain, refer 5.10.2 Sensorless Vector Control Operation Guide to on page 152.</p> | | | | | | | | | | | | | | | | | | | | | | | | | |
| <p>Cn.31 ACR SL P Gain, Cn.32 ACR SL I Gain</p> | <p>Adjusts the P and I gains of the sensorless current controller. For the adjustment of sensorless current controller gain, refer to 5.10.2 Sensorless Vector Control Operation Guide to on page 152.</p> | | | | | | | | | | | | | | | | | | | | | | | | | |
| <p>Cn.53 Torque Lmt Src</p> | <p>Select a type of torque limit setting, using the keypad, terminal block analog input (V1 and I2) or communication power. When setting torque limit, adjust the torque size by limiting the speed controller output. Set the retrograde and regenerative limits for forward and reverse operation.</p> <table border="1" data-bbox="400 1373 1234 1761"> <thead> <tr> <th data-bbox="400 1373 495 1406">Setting</th> <th data-bbox="495 1373 659 1406"></th> <th data-bbox="659 1373 1234 1406">Function</th> </tr> </thead> <tbody> <tr> <td data-bbox="400 1406 495 1439">0</td> <td data-bbox="495 1406 659 1439">KeyPad-1</td> <td data-bbox="659 1406 1234 1439">Sets the torque limit with the keypad.</td> </tr> <tr> <td data-bbox="400 1439 495 1472">1</td> <td data-bbox="495 1439 659 1472">KeyPad-2</td> <td data-bbox="659 1439 1234 1472"></td> </tr> <tr> <td data-bbox="400 1472 495 1505">2</td> <td data-bbox="495 1472 659 1505">V1</td> <td data-bbox="659 1472 1234 1505" rowspan="3">Sets the torque limit with the analog input terminal of the terminal block.</td> </tr> <tr> <td data-bbox="400 1505 495 1537">4</td> <td data-bbox="495 1505 659 1537">V2</td> </tr> <tr> <td data-bbox="400 1537 495 1570">5</td> <td data-bbox="495 1537 659 1570">I2</td> </tr> <tr> <td data-bbox="400 1570 495 1642">6</td> <td data-bbox="495 1570 659 1642">Int 485</td> <td data-bbox="659 1570 1234 1642">Sets the torque limit with the communication terminal of the terminal block.</td> </tr> <tr> <td data-bbox="400 1642 495 1713">8</td> <td data-bbox="495 1642 659 1713">FieldBus</td> <td data-bbox="659 1642 1234 1713">Sets the torque limit with the FieldBus communication option.</td> </tr> <tr> <td data-bbox="400 1713 495 1761">9</td> <td data-bbox="495 1713 659 1761">UserSeqLink</td> <td data-bbox="659 1713 1234 1761">This enters the torque reference by linking the common area with the user sequence output.</td> </tr> </tbody> </table> | Setting | | Function | 0 | KeyPad-1 | Sets the torque limit with the keypad. | 1 | KeyPad-2 | | 2 | V1 | Sets the torque limit with the analog input terminal of the terminal block. | 4 | V2 | 5 | I2 | 6 | Int 485 | Sets the torque limit with the communication terminal of the terminal block. | 8 | FieldBus | Sets the torque limit with the FieldBus communication option. | 9 | UserSeqLink | This enters the torque reference by linking the common area with the user sequence output. |
| Setting | | Function | | | | | | | | | | | | | | | | | | | | | | | | |
| 0 | KeyPad-1 | Sets the torque limit with the keypad. | | | | | | | | | | | | | | | | | | | | | | | | |
| 1 | KeyPad-2 | | | | | | | | | | | | | | | | | | | | | | | | | |
| 2 | V1 | Sets the torque limit with the analog input terminal of the terminal block. | | | | | | | | | | | | | | | | | | | | | | | | |
| 4 | V2 | | | | | | | | | | | | | | | | | | | | | | | | | |
| 5 | I2 | | | | | | | | | | | | | | | | | | | | | | | | | |
| 6 | Int 485 | Sets the torque limit with the communication terminal of the terminal block. | | | | | | | | | | | | | | | | | | | | | | | | |
| 8 | FieldBus | Sets the torque limit with the FieldBus communication option. | | | | | | | | | | | | | | | | | | | | | | | | |
| 9 | UserSeqLink | This enters the torque reference by linking the common area with the user sequence output. | | | | | | | | | | | | | | | | | | | | | | | | |

| Code | Description | | |
|-----------------------------|--|-------|---|
| | 12 | Pulse | Sets the torque limit with the pulse input of the terminal block. |
| | The torque limit can be set up to 200% of the rated motor torque. | | |
| Cn.54 FWD +Trq Lmt | Sets the torque limit for forward retrograde (motoring) operation. | | |
| Cn.55 FWD -Trq Lmt | Sets the torque limit for forward regenerative operation. | | |
| Cn.56 REV +Trq Lmt | Sets the torque limit for reverse retrograde (motoring) operation. | | |
| Cn.57 REV -Trq Lmt | Sets the torque limit for reverse regenerative operation. | | |
| In.02 Torque at 100% | Sets the maximum torque. For example, if In.02 is set to 200% and an input voltage (V1) is used, the torque limit is 200% when 10V is entered. However, when the V1 terminal is set up with the factory default setting and the torque limit setup uses a method other than the keypad, check the parameter settings in the monitor mode. In the Config Mode CNF.21-23 (only displayed when using LCD keypad), select 21 (Torque limit). | | |
| Cn.91-93 SL Volt Comp1-3 | Adjust output voltage compensation values for sensorless vector control. For output voltage compensation, refer to 5.10.2 Sensorless Vector Control Operation Guide to on page 152 . | | |
| Cn.52 Torque Out LPF | Sets the time constant for torque command by setting the torque controller output filter. | | |

⚠ Caution

Adjust the controller gain according to the load's characteristics. However, the motor can overheat or the system may become unstable depending on the controller gain settings.

Note

Speed controller gain can improve the speed control waveform while monitoring the changes in speed. If speed deviation does not decrease quickly, increase the speed controller P gain or decrease I gain (time in ms). However, if the P gain is increased too high or I gain is decreased too low, severe vibration may occur. If oscillation occurs in the speed waveform, try to increase I gain (ms) or reduce P gain to adjust the waveform.

5.10.2 Sensorless Vector Control Operation Guide

| Problem | Relevant function code | Troubleshooting |
|--|---|---|
| The amount of starting torque is insufficient. | bA.24 Tr Cn.09 PreExTime Cn.10 Flux Force Cn.31 ACR SL P Gain Cn.54-57 Trq Lmt Cn.93 SL Volt Comp3 | Set the value of Cn. 90 to be more than 3 times the value of bA.24 or increase the value of Cn.10 by increments of 50%. If the value of Cn.10 is high, an overcurrent trip at start can occur. In this case, reduce the value of Cn.31 by decrements of 10. |

| Problem | Relevant function code | Troubleshooting |
|---|---|--|
| | | Increase the value of Trg Lmt (Cn.54-57) by increments of 10%. Increase the value of Cn.93 by increments of 5. |
| The output frequency is higher than the base frequency during no-load operation at low speed (10Hz or lower). | Cn.91 SL Volt Comp1 | Decrease the value of Cn.91 by decrements of 5. |
| The motor hunts or the amount of torque is not sufficient while the load is increasing at low speed (10Hz or lower). | Cn.04 Carrier Freq Cn.21 ASR-SL P Gain1 Cn.22 ASR-SL I Gain1 Cn.93 SL Volt Comp3 | If the motor hunts at low speed, increase the value of Cn.22 by increments of 50m/s, and if hunting does not occur, increase the value of Cn.21 to find the optimal operating condition. |
| | | If the amount of torque is insufficient, increase the value of Cn.93 by increments of 5. |
| | | If the motor hunts or the amount of torque is insufficient in the 5-10Hz range, decrease the value of Cn.04 by increments of 1kHz (if Cn.04 is set to exceed 3kHz). |
| The motor hunts or overcurrent trip occurs in regenerative load at low speed (10 Hz or lower). | Cn.92 SL Volt Comp2 Cn.93 SL Volt Comp3 | Increase the value of Cn.92-93 by increments of 5 at the same time. |
| Over voltage trip occurs due to sudden acceleration/deceleration or sudden load fluctuation (with no brake resistor installed) at mid speed (30Hz or higher). | Cn.24 ASR-SL I Gain2 | Decrease the value of Cn.2 by decrements of 5%. |
| Over current trip occurs due to sudden load fluctuation at high speed (50 Hz or higher). | Cn.54-57 Trq Lmt Cn.94 SL FW Freq | Decrease the value of Cn.54-57 by decrements of 10% (if the parameter setting is 150% or higher). |
| | | Increase/decrease the value of Cn.94 by increments/decrements of 5% (set below 100%). |
| The motor hunts when the load increases from the base frequency or higher. | Cn.22 ASR-SL I Gain1 Cn.23 ASR-SL I Gain2 | Increase the value of Cn.22 by increments of 50m/s or decrease the value of Cn.24 by decrements of 5%. |
| The motor hunts as the load increases. | Cn.28 S-Est P Gain1 Cn.29 S-Est I Gain1 | At low speed (10Hz or lower), increase the value of Cn.29 by increments of 5. |
| | | At mid speed (30 Hz or higher), increase the value of Cn.28 by increments of 500. If the parameter setting is too extreme, over current trip may occur at low speed. |

| Problem | Relevant function code | Troubleshooting |
|----------------------------------|------------------------|--|
| The motor speed level decreases. | bA.20 Auto Tuning | Select 6. Tr (static type) from bA. 24 and run bA.24 Rotor time constant tuning. |

*Hunting: Symptom of irregular vibration of the equipment.

5.11 Kinetic Energy Buffering Operation

When the input power supply is disconnected, the inverter's DC link voltage decreases, and a low voltage trip occurs blocking the output. A kinetic energy buffering operation uses regenerative energy generated by the motor during the blackout to maintain the DC link voltage. This extends the time for a low voltage trip to occur, after an instantaneous power interruption.

| Group | Code | Name | LCD Display | Parameter Setting | | Setting Range | Unit |
|-------|------------------------------------|--------------------------------------|---------------|-------------------|--------------|---------------|------|
| Cn | 77 | Kinetic energy buffering selection | KEB Select | 0 | None | 0~2 | - |
| | | | | 1 | KEB-1 | | |
| | | | | 2 | KEB-2 | | |
| | 78 | Kinetic energy buffering start level | KEB Start Lev | 125.0 | | 110.0~200.0 | % |
| | 79 | Kinetic energy buffering stop level | KEB Stop Lev | 130.0 | | Cn-78~210.0 | % |
| | 80 | Energy buffering P gain | KEB P Gain | 1000 | | 0-20000 | |
| | 81 | Energy buffering I gain | KEB I Gain | 500 | | 1~20000 | |
| 82 | Energy buffering Slip gain | KEB Slip Gain | 30.0 | | 0~2000.0% | | |
| 83 | Energy buffering acceleration time | KEB Acc Time | 10.0 | | 0.0~600.0(s) | - | |
| In | 65~71 | Pn terminal function setting | Pn Define | 52 | KEB-1 Select | - | - |

Kinetic Energy Buffering Operation Setting Details

| Code | Description |
|------------------|--|
| Cn.77 KEB Select | Select the kinetic energy buffering operation when the input power is disconnected. If 1 or 2 is selected, it controls the inverter's output frequency and charges the DC link (inverter's DC part) with energy generated from the motor. Also, this function can be set using a terminal input. From the Pn terminal function settings, select KEB-1 Select, and then turn on the terminal block to run the KEB-1 function. (If KEB-1 Select is selected, KEB-1 or KEB-2 cannot be set in Cn-77.) |

| Code | | Description |
|------|---------|---|
| | Setting | Function |
| 0 | None | General deceleration is carried out until a low voltage trip occurs. |
| 1 | KEB-1 | When the input power is blocked, it charges the DC link with regenerated energy. When the input power is restored, it restores normal operation from the energy buffering operation to the frequency reference operation. KEB Acc Time in Cn-89 is applied as the operation frequency acceleration time when restoring to the normal operation. |
| 2 | KEB-2 | When the input power is blocked, it charges the DC link with regenerated energy. When the input power is restored, it changes from the energy buffering operation to the deceleration stop operation. The Dec Time in dr-04 is applied as the operation frequency deceleration time during the deceleration stop operation. |

[KEB-1]

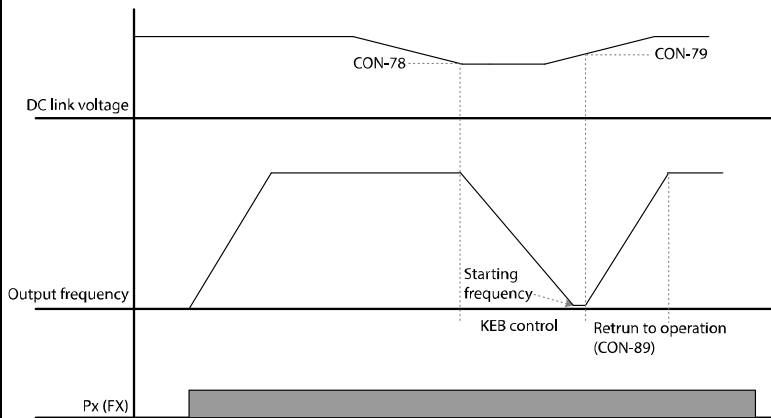

[KEB-2]

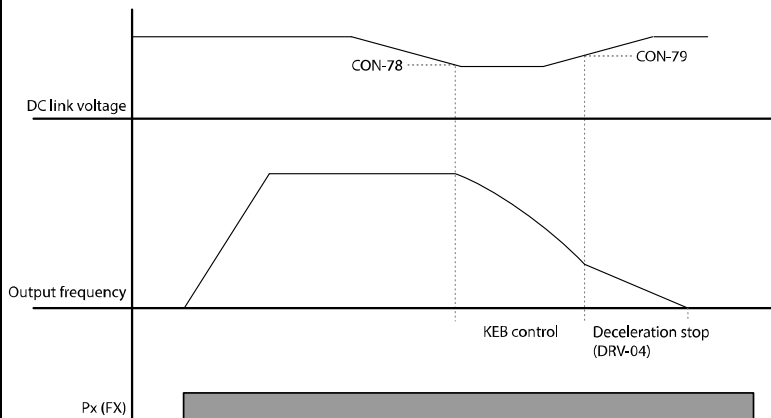

| Code | Description |
|--|---|
| Cn.78 KEB Start Lev, Cn.79 KEB Stop Lev | Sets the start and stop points of the kinetic energy buffering operation. The set values must be based on the low voltage trip level as 100% and the stop level (Cn. 79) must be set higher than the start level (Cn.78). |
| Cn.80 KEB P Gain | The controller P Gain is for maintaining the voltage of the DC power section during the kinetic energy buffering operation. Change the setting value when a low voltage trip occurs right after a power failure. |
| Cn.81 KEB I Gain | The controller I Gain is for maintaining the voltage of the DC power section during the kinetic energy buffering operation. Sets the gain value to maintain the frequency during the kinetic energy buffering operation until the inverter stops. |
| Cn.82 KEB Slip Gain | The slip gain is for preventing a low voltage trip due to load when the kinetic energy buffering operation start from blackout. |
| Cn.83 KEB Acc Time | Set the acceleration time of operation frequency when it restores normal operation from the kinetic energy buffering operation under the input power is restored. |

You select KEB-1 mode,

⚠ Caution

Depending on the duration of Instantaneous power interruptions and the amount of load inertia, a low voltage trip may occur even during a kinetic energy buffering operation. Motors may vibrate during kinetic energy buffering operation for some loads except variable torque load (for example, fan or pump loads).

5.12 Torque Control

When the motor output torque is greater than the load, the speed of motor becomes too fast. To prevent this, set the speed limit. (The torque control function cannot be used while the speed limit function is running.)

The torque control function controls the motor to maintain the preset torque value. The motor rotation speed maintains the speed constantly when the output torque and load torque of the motor keep a balance. Therefore, the motor rotation speed is decided by the load when controlling the torque.

Torque control setting option

| Group | Code | Name | LCD Display | Parameter Setting | Unit | |
|-------|------|----------------|----------------|-------------------|---------------|---|
| dr | 09 | Control mode | Control Mode | 4 | IM Sensorless | - |
| | 10 | Torque control | Torque Control | 1 | Yes | - |

Torque control setting option details

| Group | Code | Name | Parameter Setting | | Unit |
|-------|-------|----------------|-------------------|---------------|------|
| dr | 02 | Cmd Torque | - | 0.0 | % |
| | 08 | Trq Ref Src | 0 | Keypad-1 | - |
| | 09 | Control Mode | 4 | IM Sensorless | - |
| | 10 | Torque Control | 1 | Yes | - |
| | 22 | (+) Trq Gain | - | 50-150 | % |
| | 23 | (-) Trq Gain | - | 50-150 | % |
| bA | 20 | Auto Tuning | 1 | Yes | - |
| Cn | 62 | Speed LmtSrc | 0 | Keypad-1 | - |
| | 63 | FWD Speed Lmt | - | 60.00 | Hz |
| | 64 | REV Speed Lmt | - | 60.00 | Hz |
| | 65 | Speed Lmt Gain | - | 100 | % |
| In | 65-71 | Px Define | 35 | Speed/Torque | - |
| OU | 31-33 | Relay x or Q1 | 27 | Torque Dect | - |
| | 59 | TD Level | - | 100 | % |
| | 60 | TD Band | - | 5.0 | % |

Note

- To operate in torque control mode, basic operation conditions must be set. For more information, refer to *Sensorless* Vector Control Operation Guide to on page 152.
- The torque control cannot be used in a low speed regeneration area or low load conditions.
- If you change the rotation direction while operating, an over current trip or low speed reverse direction error will be generated.

Torque reference setting option

The torque reference can be set using the same method as the target frequency setting. If Torque Control Mode is selected, the target frequency is not used.

| Group | Code | Name | LCD Display | Parameter Setting | | Unit |
|-------|------|--------------------------|-------------|-------------------|----------|------|
| dr | 02 | Torque command | Cmd Torque | -180-180 | | % |
| | 08 | Torque reference setting | Trq Ref Src | 0 | Keypad-1 | - |
| | | | | 1 | Keypad-2 | |
| | | | | 2 | V1 | |
| | | | | 4 | V2 | |
| | | | | 5 | I2 | |
| | | | | 6 | Int 485 | |

| Group | Code | Name | LCD Display | Parameter Setting | | Unit |
|-------|----------------------------|--------------------------------|----------------|----------------------|----------------|------|
| | | | | 8 | FieldBus | |
| | | | | 9 | UserSeqLink | |
| | | | | 12 | Pulse | |
| Cn | 62 | Speed limit setting | Speed LmtSrc | 0 | Keypad-1 | - |
| | | | | 1 | Keypad-2 | |
| | | | | 2 | V1 | |
| | | | | 4 | V2 | |
| | | | | 5 | I2 | |
| | | | | 6 | Int 485 | |
| | | | | 7 | FieldBus | |
| | | | | 8 | UserSeqLink | |
| | 63 | Positive-direction speed limit | FWD Speed Lmt | 0-Maximum frequency | | Hz |
| | 64 | Negative-direction speed limit | REV Speed Lmt | 0- Maximum frequency | | Hz |
| 65 | Speed limit operation gain | Speed Lmt Gain | 100-5000 | | % | |
| In | 02 | Torque at maximum analog input | Torque at 100% | -12.00-12.00 | | mA |
| CNF* | 21 | Monitor mode display 1 | Monitor Line-1 | 1 | Speed | |
| | 22 | Monitor mode display 2 | Monitor Line-2 | 2 | Output Current | |
| | 23 | Monitor mode display 3 | Monitor Line-3 | 3 | Output Voltage | |

*Available on LCD keypad only.

Torque reference setting details

| Code | Description | | | | | | | | | | | | | | | | | |
|-------|--|-------------|-------------------|-------------|---|----------|---|----------|-------|----------|---|---------|---|----------|---|-------------|----|-------|
| dr-08 | Select an input method to use as the torque reference. | | | | | | | | | | | | | | | | | |
| | <table border="1"> <thead> <tr> <th>Parameter Setting</th> <th>Description</th> </tr> </thead> <tbody> <tr> <td>0</td> <td>Keypad-1</td> </tr> <tr> <td>1</td> <td>Keypad-2</td> </tr> <tr> <td>2,4,5</td> <td>V1,V2,I2</td> </tr> <tr> <td>6</td> <td>Int 485</td> </tr> <tr> <td>8</td> <td>FieldBus</td> </tr> <tr> <td>9</td> <td>UserSeqLink</td> </tr> <tr> <td>12</td> <td>Pulse</td> </tr> </tbody> </table> | | Parameter Setting | Description | 0 | Keypad-1 | 1 | Keypad-2 | 2,4,5 | V1,V2,I2 | 6 | Int 485 | 8 | FieldBus | 9 | UserSeqLink | 12 | Pulse |
| | Parameter Setting | Description | | | | | | | | | | | | | | | | |
| | 0 | Keypad-1 | | | | | | | | | | | | | | | | |
| | 1 | Keypad-2 | | | | | | | | | | | | | | | | |
| | 2,4,5 | V1,V2,I2 | | | | | | | | | | | | | | | | |
| | 6 | Int 485 | | | | | | | | | | | | | | | | |
| | 8 | FieldBus | | | | | | | | | | | | | | | | |
| | 9 | UserSeqLink | | | | | | | | | | | | | | | | |
| 12 | Pulse | | | | | | | | | | | | | | | | | |
| | Sets the torque reference with the keypad. | | | | | | | | | | | | | | | | | |
| | Sets the torque reference using the voltage or current input terminal of the terminal block. | | | | | | | | | | | | | | | | | |
| | Sets the torque reference with the communication terminal of the terminal block. | | | | | | | | | | | | | | | | | |
| | Input the torque reference using the inverter's FieldBus option. | | | | | | | | | | | | | | | | | |
| | Enters torque reference by linking common area with the user sequence output. | | | | | | | | | | | | | | | | | |
| | Input the torque reference using the pulse input on | | | | | | | | | | | | | | | | | |

| Code | Description |
|-----------|--|
| | the inverter's terminal block. |
| Cn-02 | The torque reference can be set up to 180% of the maximum rated motor torque. |
| In-02 | Sets the maximum torque. You can check the set maximum torque in Monitor (MON) mode. |
| CNF-21~23 | Select a parameter from the Config(CNF) mode and then select(19 Torque Ref). |

Speed limit details

| Code | Description | | | | | | | | | | | | | | |
|-----------|--|-------------------|-------------|---|----------|---|----------|-------|----------|---|---------|---|----------|---|-------------|
| Cn-62 | Select a method for setting the speed limit value. | | | | | | | | | | | | | | |
| | <table border="1"> <thead> <tr> <th>Parameter Setting</th> <th>Description</th> </tr> </thead> <tbody> <tr> <td>0</td> <td>Keypad-1</td> </tr> <tr> <td>1</td> <td>Keypad-2</td> </tr> <tr> <td>2,4,5</td> <td>V1,V2,I2</td> </tr> <tr> <td>6</td> <td>Int 485</td> </tr> <tr> <td>7</td> <td>FieldBus</td> </tr> <tr> <td>8</td> <td>UserSeqLink</td> </tr> </tbody> </table> | Parameter Setting | Description | 0 | Keypad-1 | 1 | Keypad-2 | 2,4,5 | V1,V2,I2 | 6 | Int 485 | 7 | FieldBus | 8 | UserSeqLink |
| | Parameter Setting | Description | | | | | | | | | | | | | |
| | 0 | Keypad-1 | | | | | | | | | | | | | |
| | 1 | Keypad-2 | | | | | | | | | | | | | |
| | 2,4,5 | V1,V2,I2 | | | | | | | | | | | | | |
| | 6 | Int 485 | | | | | | | | | | | | | |
| 7 | FieldBus | | | | | | | | | | | | | | |
| 8 | UserSeqLink | | | | | | | | | | | | | | |
| | Sets the speed limit value with the keypad. | | | | | | | | | | | | | | |
| | Sets the speed limit value using the same method as the frequency command. You can check the setting in Monitor (MON) mode. | | | | | | | | | | | | | | |
| Cn-63 | Sets the positive-direction speed limit value. | | | | | | | | | | | | | | |
| Cn-64 | Sets the negative-direction speed limit value. | | | | | | | | | | | | | | |
| Cn-65 | Sets the decrease rate of the torque reference when the motor speed exceeds the speed limit value. | | | | | | | | | | | | | | |
| CNF-21~23 | Select a parameter from the Config (CNF) mode and then select21 Torque Bias. | | | | | | | | | | | | | | |
| In 65-71 | Select a multi-functional input terminal to set as the (35 Speed/Torque). If you turn on the terminal while the operation is stopped, it operates in vector control (speed limit) mode. | | | | | | | | | | | | | | |

5.13 Energy Saving Operation

5.13.1 Manual Energy Saving Operation

If the inverter output current is lower than the current which is set at bA.14 (Noload Curr), the output voltage must be reduced as low as the level set at Ad.51 (Energy Save). The voltage before the energy saving operation starts will become the base value of the percentage. Manual energy saving operation will not be carried out during acceleration and deceleration.

| Group | Code | Name | LCD Display | Parameter Setting | | Setting Range | Unit |
|-------|------|-------------------------|-------------|-------------------|--------|---------------|------|
| Ad | 50 | Energy saving operation | E-Save Mode | 1 | Manual | - | - |
| | 51 | Energy saving amount | Energy Save | 30 | | 0-30 | % |

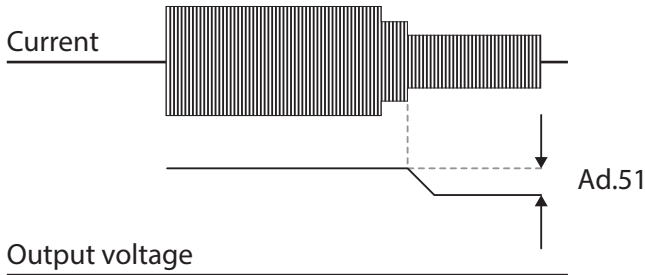

5.13.2 Automatic Energy Saving Operation

The amount of energy saving can be automatically calculated based on the rated motor current (bA.13) and the no-load current (bA.14). From the calculations, the output voltage can be adjusted.

| Group | Code | Name | LCD Display | Parameter Setting | | Setting Range | Unit |
|-------|------|-------------------------|-------------|-------------------|------|---------------|------|
| Ad | 50 | Energy saving operation | E-Save Mode | 2 | Auto | - | - |

⚠ Caution

If operation frequency is changed or acceleration and /deceleration is carried out by a stop command during the energy saving operation, the actual Acc/Dec time may take longer than the set Acc/Dec time due to the time required to return to the general operation from the energy saving operation.

5.14 Speed Search Operation

This operation is used to prevent fault trips that can occur while the inverter output voltage is disconnected and the motor is idling. Because this feature estimates the motor rotation speed based on the inverter output current, it does not give the exact speed.





| Group | Code | Name | LCD Display | Parameter Setting | | Setting Range | Unit |
|-------|------|----------------------------------|--------------|-------------------|----------------|---------------|------|
| Cn | 70 | Speed search mode selection | SS Mode | 0 | Flying Start-1 | - | - |
| | 71 | Speed search operation selection | Speed Search | 0000* | | - | bit |

| Group | Code | Name | LCD Display | Parameter Setting | Setting Range | Unit |
|-------|------|---------------------------------------|----------------|-------------------|---------------|------|
| | 72 | Speed search reference current | SS Sup-Current | - Below 75kW | 80-200 | % |
| | 73 | Speed search proportional gain | SS P-Gain | 100 | 0-9999 | - |
| | 74 | Speed search integral gain | SS I-Gain | 200 | 0-9999 | - |
| | 75 | Output block time before speed search | SS Block Time | 1.0 | 0-60 | sec |
| OU | 31 | Multi-function relay 1 item | Relay 1 | 19 Speed Search | - | - |
| | 33 | Multi-function output 1 item | Q1 Define | | | |

*Displayed as  on the Keypad.

Speed Search Operation Setting Details

| Code | Description | | | | | | |
|------------------|--|----------|----------|------------------|--|------------------|---|
| Cn.70 SS Mode | Select a speed search type. | | | | | | |
| | <table border="1"> <thead> <tr> <th>Setting</th> <th>Function</th> </tr> </thead> <tbody> <tr> <td>0 Flying Start-1</td> <td>The speed search is carried out as it controls the inverter output current during idling below the Cn.72 (SS Sup-Current) parameter setting. If the direction of the idling motor and the direction of operation command at restart are the same, a stable speed search function can be performed at about 10 Hz or lower. However, if the direction of the idling motor and the direction of operation command at restart are different, the speed search does not produce a satisfactory result because the direction of idling cannot be established.</td> </tr> <tr> <td>1 Flying Start-2</td> <td>The speed search is carried out as it PI controls the ripple current which is generated by the counter electromotive force during no-load rotation. Because this mode establishes the direction of the idling motor (forward/reverse), the speed search function is stable regardless of the direction of the idling motor and direction of operation command. However because the ripple current is used which is generated by the counter electromotive force at idle (the counter electromotive force is proportional to the idle speed), the idle frequency is not determined accurately and re-acceleration may start from zero speed when the speed search is performed for the</td> </tr> </tbody> </table> | Setting | Function | 0 Flying Start-1 | The speed search is carried out as it controls the inverter output current during idling below the Cn.72 (SS Sup-Current) parameter setting. If the direction of the idling motor and the direction of operation command at restart are the same, a stable speed search function can be performed at about 10 Hz or lower. However, if the direction of the idling motor and the direction of operation command at restart are different, the speed search does not produce a satisfactory result because the direction of idling cannot be established. | 1 Flying Start-2 | The speed search is carried out as it PI controls the ripple current which is generated by the counter electromotive force during no-load rotation. Because this mode establishes the direction of the idling motor (forward/reverse), the speed search function is stable regardless of the direction of the idling motor and direction of operation command. However because the ripple current is used which is generated by the counter electromotive force at idle (the counter electromotive force is proportional to the idle speed), the idle frequency is not determined accurately and re-acceleration may start from zero speed when the speed search is performed for the |
| | Setting | Function | | | | | |
| 0 Flying Start-1 | The speed search is carried out as it controls the inverter output current during idling below the Cn.72 (SS Sup-Current) parameter setting. If the direction of the idling motor and the direction of operation command at restart are the same, a stable speed search function can be performed at about 10 Hz or lower. However, if the direction of the idling motor and the direction of operation command at restart are different, the speed search does not produce a satisfactory result because the direction of idling cannot be established. | | | | | | |
| 1 Flying Start-2 | The speed search is carried out as it PI controls the ripple current which is generated by the counter electromotive force during no-load rotation. Because this mode establishes the direction of the idling motor (forward/reverse), the speed search function is stable regardless of the direction of the idling motor and direction of operation command. However because the ripple current is used which is generated by the counter electromotive force at idle (the counter electromotive force is proportional to the idle speed), the idle frequency is not determined accurately and re-acceleration may start from zero speed when the speed search is performed for the | | | | | | |

| Code | Description | | | | |
|---|---|---|---|------------------------|--|
| | | | idling motor at low speed (about 10 - 15 Hz, though it depends on motor characteristics). | | |
| Cn.71 Speed Search | Speed search can be selected from the following 4 options. If the top display segment is on it is enabled (On), and if the bottom segment is on it is disabled (Off). | | | | |
| | Item | Bit Setting On Status | Bit setting Off Status | | |
| | Keypad |  |  | | |
| | LCD keypad |  |  | | |
| | Type and Functions of Speed Search Setting | | | | |
| | Setting | | | Function | |
| | bit4 | bit3 | bit2 | bit1 | |
| | | | | ✓ | Speed search for general acceleration |
| | | | ✓ | | Initialization after a fault trip |
| | | ✓ | | | Restart after instantaneous power interruption |
| ✓ | | | | Starting with power-on | |
| <ul style="list-style-type: none"> • Speed search for general acceleration: If bit 1 is set to 1 and the inverter operation command runs, acceleration starts with speed search operation. When the motor is rotating under load, a fault trip may occur if the operation command is run for the inverter to provide output voltage. The speed search function prevents such fault trip from occurring. • Initialization after a fault trip: If Bit 2 is set to 1 and Pr.08 (RST Restart) is set to 1 (Yes), the speed search operation automatically accelerates the motor to the operation frequency used before the fault trip, when the [Reset] key is pressed (or the terminal block is initialized) after a fault trip. • Automatic restart after reset of a fault trip: If bit 3 is set to 1, and if a low voltage trip occurs due to a power interruption but the power is restored before the internal power shuts down, the speed search operation accelerates the motor back to its frequency reference before the low voltage trip. <p>If an instantaneous power interruption occurs and the input power is disconnected, the inverter generates a low voltage trip and blocks the output. When the input power returns, the operation frequency before the low voltage trip and the voltage is increased by the inverter's inner PI control.</p> | | | | | |

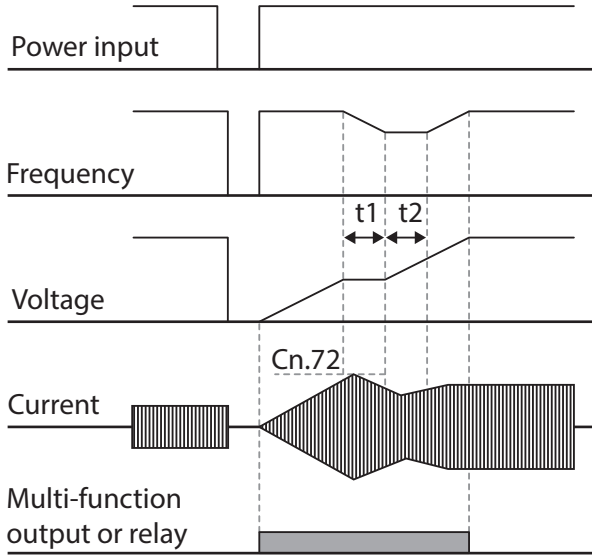
| Code | Description |
|--|---|
| | <p>If the current increases above the value set at Cn.72, the voltage stops increasing and the frequency decreases (t1 zone). If the current decreases below the value set at Cn.27, the voltage increases again and the frequency stops decelerating (t2 zone). When the normal frequency and voltage are resumed, the speed search operation accelerates the motor back to its frequency reference before the fault trip.</p>  <ul style="list-style-type: none"> • Starting with power-on: Set bit 4 to 1 and Ad.10 (Power-on Run) to 1 (Yes). If inverter input power is supplied while the inverter operation command is on, the speed search operation will accelerate the motor up to the frequency reference. |
| Cn.72 SS Sup-Current | The amount of current flow is controlled during speed search operation based on the motor's rated current. If Cn.70 (SS mode) is set to 1 (Flying Start-2), this code is not visible. |
| Cn.73 SS P/I-Gain, Cn.75 SS Block Time | The P/I gain of the speed search controller can be adjusted. If Cn.70 (SS Mode) is set to 1 (Flying Start-2), different factory defaults based on motor capacity are used and defined in dr.14 (Motor Capacity). |

Note

- If operated within the rated output, the S100 series inverter is designed to withstand instantaneous power interruptions within 15 ms and maintain normal operation. Based on the rated heavy load current, safe operation during an instantaneous power interruption is guaranteed for 200V and 400V inverters (whose rated input voltages are 200-230 VAC and 380-460 VAC respectively).

- The DC voltage inside the inverter may vary depending on the output load. If the power interruption time is longer than 15 ms, a low voltage trip may occur.

⚠ Caution

When operating in sensorless II mode while the starting load is in free-run, the speed search function (for general acceleration) must be set for smooth operation. If the speed search function is not set, an overcurrent trip or overload trip may occur.

5.15 Auto Restart Settings

When inverter operation stops due to a fault and a fault trip is activated, the inverter automatically restarts based on the parameter settings.

| Group | Code | Name | LCD Display | Parameter Setting | | Setting Range | Unit |
|-------|------|--|----------------|-------------------|----|---------------|------|
| Pr | 08 | Select start at trip reset | RST Restart | 0 | No | 0-1 | - |
| | 09 | Auto restart count | Retry Number | 0 | | 0-10 | - |
| | 10 | Auto restart delay time | Retry Delay | 1.0 | | 0.0-60.0 | s |
| Cn | 71 | Select speed search operation | Speed Search | - | | 0000*-1111 | bit |
| | 72 | Speed search startup current | SS Sup-Current | 150 | | 80-200 | % |
| | 73 | Speed search proportional gain | SS P-Gain | 100 | | 0-9999 | |
| | 74 | Speed search integral gain | SS I-Gain | 200 | | 0-9999 | |
| | 75 | Output block time before speed search. | SS Block Time | 1.0 | | 0.0-60.0 | s |

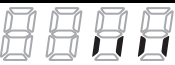
*Displayed as  on the keypad.

Auto Restart Setting Details

| Code | Description |
|--|---|
| Pr.08 RST Restart, Pr.09 Retry Number, Pr.10 Retry Delay | <p>Only operates when Pr.08 (RST Restart) is set to 1(Yes). The number of attempts to try the auto restart is set at Pr.09 (Auto Restart Count).</p> <p>If a fault trip occurs during operation, the inverter automatically restarts after the set time programmed at Pr.10 (Retry Delay). At each restart, the inverter counts the number of tries and subtracts it from the number set at Pr.09 until the retry number count reaches 0.</p> <p>After an auto restart, if a fault trip does not occur within 60 sec, it will increase the restart count number. The maximum count number is limited by the</p> |

| Code | Description |
|------|--|
| | number set at Pr.09 (Auto Restart Count). If the inverter stops due to low voltage, emergency stop (Bx), inverter overheating, or hardware diagnosis, an auto restart is not activated. At auto restart, the acceleration options are identical to those of speed search operation. Codes Cn.72-75 can be set based on the load. Information about the speed search function can be found at 5.14 Speed Search Operation on page 160. |

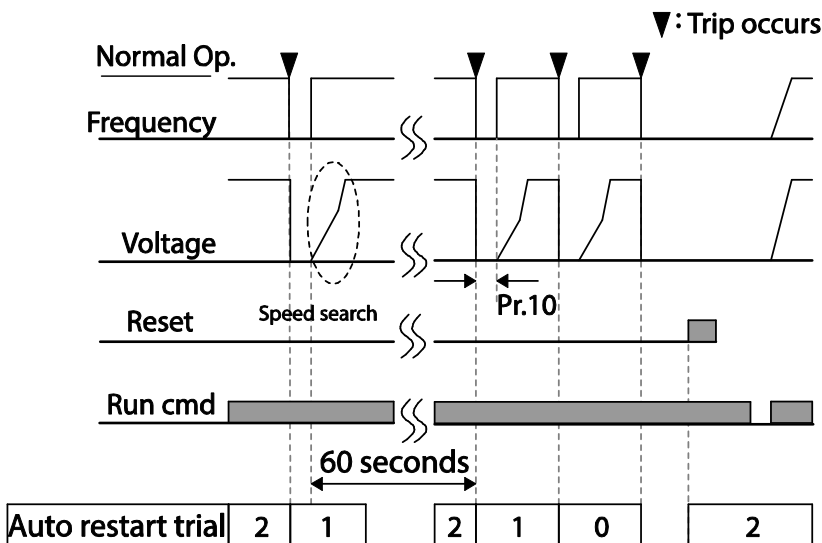

[Example of auto restart with a setting of 2]

⚠ Caution

If the auto restart number is set, be careful when the inverter resets from a fault trip. The motor may automatically start to rotate.

5.16 Operational Noise Settings (carrier frequency settings)

| Group | Code | Name | LCD Display | Parameter Setting | Setting Range | Unit |
|-------|------|-------------------|--------------|-------------------|---------------|------|
| Cn | 04 | Carrier Frequency | Carrier Freq | 3.0 | 1.0-15.0 | kHz |
| | 05 | Switching Mode | PWM* Mode | 0 Normal PWM | 0-1 | - |

* PWM: Pulse width modulation

Operational Noise Setting Details

| Code | Description | | | | | | | | | | | | | | | | | | | |
|--------------------|--|------------|-------------------|--|--------|-------|-----------------|------------|-------------|---|---|-----------------|---|---|------------------|---|---|-----------------|---|---|
| Cn.04 Carrier Freq | Adjust motor operational noise by changing carrier frequency settings. Power transistors (IGBT) in the inverter generate and supply high frequency switching voltage to the motor. The switching speed in this process refers to the carrier frequency. If the carrier frequency is set high, it reduces operational noise from the motor, and if the carrier frequency is set low, it increases operational noise from the motor. | | | | | | | | | | | | | | | | | | | |
| Cn.05 PWM Mode | <p>The heat loss and leakage current from the inverter can be reduced by changing the load rate option at Cn.05 (PWM Mode). Selecting 1 (LowLeakage PWM) reduces heat loss and leakage current, compared to when 0 (Normal PWM) is selected. However, it increases the motor noise. Low leakage PWM uses 2 phase PWM modulation mode, which helps minimize degradation and reduces switching loss by approximately 30%.</p> <table border="1"> <thead> <tr> <th rowspan="3">Item</th> <th colspan="2">Carrier frequency</th> </tr> <tr> <th>1.0kHz</th> <th>15kHz</th> </tr> <tr> <th>Low Leakage PWM</th> <th>Normal PWM</th> </tr> </thead> <tbody> <tr> <td>Motor noise</td> <td>↑</td> <td>↓</td> </tr> <tr> <td>Heat generation</td> <td>↓</td> <td>↑</td> </tr> <tr> <td>Noise generation</td> <td>↓</td> <td>↑</td> </tr> <tr> <td>Leakage current</td> <td>↓</td> <td>↑</td> </tr> </tbody> </table> | Item | Carrier frequency | | 1.0kHz | 15kHz | Low Leakage PWM | Normal PWM | Motor noise | ↑ | ↓ | Heat generation | ↓ | ↑ | Noise generation | ↓ | ↑ | Leakage current | ↓ | ↑ |
| Item | Carrier frequency | | | | | | | | | | | | | | | | | | | |
| | 1.0kHz | | 15kHz | | | | | | | | | | | | | | | | | |
| | Low Leakage PWM | Normal PWM | | | | | | | | | | | | | | | | | | |
| Motor noise | ↑ | ↓ | | | | | | | | | | | | | | | | | | |
| Heat generation | ↓ | ↑ | | | | | | | | | | | | | | | | | | |
| Noise generation | ↓ | ↑ | | | | | | | | | | | | | | | | | | |
| Leakage current | ↓ | ↑ | | | | | | | | | | | | | | | | | | |

Note

Carrier Frequency at Factory Default Settings (0.4-22kW)

- Normal load: 2kHz (Max 5kHz)
- Heavy load: 3kHz (Max 15kHz)

S100 Series Inverter Derating Standard

- S100 inverter is designed to respond to two types of load rates. Heavy load (heavy duty) and normal load (normal duty). The overload rate represents an acceptable load amount that exceeds rated load, and is expressed in a ratio based on the rated load and the duration. The overload capacity on the S100 series inverter is 150%/1min for heavy loads, and 120%/1min for normal loads.
- The current rating differs from the load rating, as it also has an ambient temperature limit. For derating specifications, refer to [11.8 Continuous Rated Current Derating](#) on page 360.
- Current rating for ambient temperature at normal load operation.

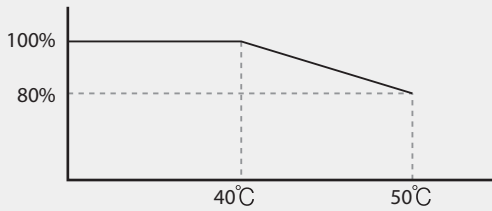

[Ambient temperature versus current rating at normal load]

- Guaranteed carrier frequency for current rating by load.

| Inverter capacity | Normal load | Heavy load |
|-------------------|-------------|------------|
| 0.4–22kW | 2kHz | 6kHz |

5.17 2nd Motor Operation

The 2nd motor operation is used when a single inverter switch operates two motors. Using the 2nd motor operation, a parameter for the 2nd motor is set. The 2nd motor is operated when a multi-function terminal input defined as a 2nd motor function is turned on.

| Group | Code | Name | LCD Display | Parameter Setting | | Setting Range | Unit |
|-------|--------|---------------------------|----------------------|-------------------|-----------|---------------|------|
| In | 65- 71 | Px terminal configuration | Px Define(Px: P1–P7) | 26 | 2nd Motor | - | - |

2nd Motor Operation Setting Details

| Code | Description |
|--------------------|---|
| In.65–71 Px Define | Set one of the the multi-function input terminals (P1–P5) to 26 (2 nd Motor) to display M2 (2 nd motor group) group. An input signal to a multi-function terminal set to 2 nd motor will operate the motor according to the code settings listed below. However, if the inverter is in operation, input signals to the multi-function terminals will not read as a 2 nd motor parameter. Pr.50 (Stall Prevent) must be set first, before M2.28 (M2-Stall Lev) settings can be used. Also, Pr.40 (ETH Trip Sel) must be set first, before M2.29 (M2-ETH 1min) and M2.30 (M2.ETH Cont) settings. |

Parameter Setting at Multi-function Terminal Input on a 2nd Motor

| Code | Description | Code | Description |
|-----------------|----------------------|------------------|--------------------|
| M2.04 Acc Time | Acceleration time | M2.16 Inertia Rt | Load inertia rate |
| M2.05 Dec Time | Deceleration time | M2.17 Rs | Stator resistance |
| M2.06 Capacity | Motor capacity | M2.18 Lsigma | Leakage inductance |
| M2.07 Base Freq | Motor base frequency | M2.19 Ls | Stator inductance |

| Code | Description | Code | Description |
|-------------------|---------------------|-----------------|---|
| M2.08 Ctrl Mode | Control mode | M2.20 Tr | Rotor time constant |
| M2.10 Pole Num | Pole number | M2.25 V/F Patt | V/F pattern |
| M2.11 Rate Slip | Rated slip | M2.26 Fwd Boost | Forward torque boost |
| M2.12 Rated Curr | Rated current | M2.27 Rev Boost | Reverse torque boost |
| M2.13 Noload Curr | No-load current | M2.28 Stall Lev | Stall prevention level |
| M2.14 Rated Volt | Motor rated voltage | M2.29 ETH 1min | Motor heat protection 1min rating |
| M2.15 Efficiency | Motor efficiency | M2.30 ETH Cont | Motor heat protection continuous rating |

Example - 2nd Motor Operation

Use the 2nd motor operation when switching operation between a 7.5kW motor and a secondary 3.7kW motor connected to terminal P3. Refer to the following settings.

| Group | Code | Name | LCD Display | Parameter Setting | Setting Range | Unit |
|-------|------|---------------------------|--------------|-------------------|---------------|------|
| In | 67 | Terminal P3 configuration | P3 Define | 26 | 2nd Motor | - |
| M2 | 06 | Motor capacity | M2-Capacity | - | 3.7kW | - |
| | 08 | Control mode | M2-Ctrl Mode | 0 | V/F | - |

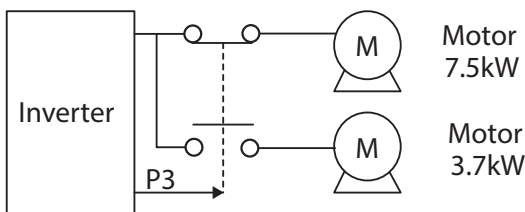

5.18 Supply Power Transition

Supply power transition is used to switch the power source for the motor connected to the inverter from the inverter output power to the main supply power source (commercial power source), or vice versa.

| Group | Code | Name | LCD Display | Parameter Setting | Setting Range | Unit |
|-------|-------|------------------------------|----------------------|-------------------|---------------|------|
| In | 65-71 | Px terminal configuration | Px Define(Px: P1-P7) | 16 | Exchange | - |
| OU | 31 | Multi-function relay1 items | Relay1 | 17 | Inverter Line | - |
| | 33 | Multi-function output1 items | Q1 Define | 18 | Comm Line | - |

Supply Power Transition Setting Details

| Code | Description |
|---------------------------------------|---|
| In.65-71 Px Define | When the motor power source changes from inverter output to main supply power, select a terminal to use and set the code value to 16 (Exchange). Power will be switched when the selected terminal is on. To reverse the transition, switch off the terminal. |
| OU.31 Realy 1 Define, OU.33 Q1 Define | <p>Set multi-function relay or multi-function output to 17 (Inverter Line) or 18 (COMM line). Relay operation sequence is as follows.</p> |

5.19 Cooling Fan Control

This function turns the inverter’s heat-sink cooling fan on and off. It is used in situations where the load stops and starts frequently, or noise free environment is required. The correct use of cooling fan control can extend the cooling fan’s life.

| Group | Code | Name | LCD Display | Parameter Setting | Setting Range | Unit |
|-------|------|---------------------|-------------|-------------------|---------------|------|
| Ad | 64 | Cooling fan control | FAN Control | 0 During Run | 0-2 | - |

Cooling Fan Control Detail Settings

| Code | Description | | |
|-------------------|--------------|---|--|
| Ad.64 Fan Control | Settings | | |
| | Description | | |
| | 0 | During Run | Cooling fan runs when the power is supplied to the inverter and the operation command is on. The cooling fan stops when the power is supplied to the inverter and the operation command is off. When the inverter heat sink temperature is higher than its set value, the cooling fan operates automatically regardless of its operation status. |
| | 1 | Always On | Cooling fan runs constantly if the power is supplied to the inverter. |
| 2 | Temp Control | With power connected and the run operation command on, if the setting is in Temp Control, the cooling fan will not operate unless the temperature in the heat sink reaches the set temperature. | |

Note

Despite setting Ad.64 to 0(During Run), if the heat sink temperature reaches a set level by current input harmonic wave or noise, the cooling fan may run as a protection function.

5.20 Input Power Frequency and Voltage Settings

Select the frequency for inverter input power. If the frequency changes from 60Hz to 50Hz, all other frequency (or RPM) settings including the maximum frequency, base frequency etc., will change to 50Hz. Likewise, changing the input power frequency setting from 50Hz to 60Hz will change all related function item settings from 50Hz to 60Hz.

| Group | Code | Name | LCD Display | Parameter Setting | | Setting Range | Unit |
|-------|------|-----------------------|--------------|-------------------|------|---------------|------|
| bA | 10 | Input power frequency | 60/50 Hz Sel | 0 | 60Hz | 0-1 | - |

Set Inverter input power voltage at bA.19. Low voltage fault trip level changes automatically to the set voltage standard.

| Group | Code | Name | LCD Display | Parameter Setting | | Setting Range | Unit |
|-------|------|---------------------|---------------|-------------------|-----|---------------|------|
| bA | 19 | Input power voltage | AC Input Volt | 220V | 220 | 170-240 | V |
| | | | | 400V | 380 | 320-480 | |

5.21 Read, Write, and Save Parameters

Use read, write and save function parameters on the inverter to copy parameters from the inverter to the keypad or from the keypad to the inverter.

| Group | Code | Name | LCD Display | Parameter Setting | | Setting Range | Unit |
|-------|------|-----------------|-----------------|-------------------|-----|---------------|------|
| CNF* | 46 | Parameter read | Parameter Read | 1 | Yes | - | - |
| | 47 | Parameter write | Parameter Write | 1 | Yes | - | - |
| | 48 | Parameter save | Parameter Save | 1 | Yes | - | - |

*Available on LCD keypad only.

Read, Write, and Save Parameter Setting Details

| Code | Description |
|------------------------|---|
| CNF-46 Parameter Read | Copies saved parameters from the inverter to the keypad. Saved parameters on the keypad will be deleted and replaced with copied parameters. |
| CNF-47 Parameter Write | Copies saved parameters from the keypad to the inverter. Saved parameters on the inverter will be deleted and replaced with copied parameters. If an error occurs during parameter writing, previous saved data will be used. If there is no saved data on the Keypad, 'EEP Rom Empty' message will be displayed. |
| CNF-48 Parameter Save | As parameters set during communication transmission are saved to RAM, the setting values will be lost if the power goes off and on. When setting parameters during communication transmission, select 1 (Yes) from CNF-48 code to save the set parameter. |

5.22 Parameter Initialization

User changes to parameters can be initialized (reset) to factory default settings on all or selected groups. However, during a fault trip situation or operation, parameters cannot be initialized.

| Group | Code | Name | LCD Display | Parameter Setting | | Setting Range | Unit |
|-------|------|--------------------------|----------------|-------------------|----|---------------|------|
| dl* | 93 | Parameter initialization | - | 0 | No | 0-16 | |
| CNF** | 40 | Parameter initialization | Parameter Init | 0 | No | 0-16 | |

* For keypad

** For LCD keypad

Parameter Initialization Setting Details

| Code | | Description | | | |
|---------------------------------|---------------------------|-----------------------|-------------|--|--|
| dr.93, CNF-40 Parameter Init | Setting | | LCD Display | Function | |
| | 0 | No | No | - | |
| | 1 | Initialize all groups | All Grp | Initialize all data. Select 1(All Grp) and press [PROG/ENT] key to start initialization. On completion, 0(No) will be displayed. | |
| | 2 | Initialize dr group | DRV Grp | Initialize data by groups. Select initialize group and press [PROG/ENT] key to start initialization. On completion, 0(No) will be displayed. | |
| | 3 | Initialize bA group | BAS Grp | | |
| | 4 | Initialize Ad group | ADV Grp | | |
| | 5 | Initialize Cn group | CON Grp | | |
| | 6 | Initialize In group | IN Grp | | |
| | 7 | Initialize OU group | OUT Grp | | |
| | 8 | Initialize CM group | COM Grp | | |
| | 9 | Initialize AP group | APP Grp | | |
| | 12 | Initialize Pr group | PRT Grp | | |
| | 13 | Initialize M2 group | M2 Grp | | |
| 16 | Initialize OperationGroup | SPS Grp | | | |

5.23 Parameter View Lock

Use parameter view lock to hide parameters after registering and entering a user password.

| Group | Code | Name | LCD Display | Parameter Setting | Setting Range | Unit |
|-------|------|------------------------------|---------------|-------------------|---------------|------|
| CNF* | 50 | Parameter view lock | View Lock Set | Unlocked | 0-9999 | |
| | 51 | Parameter view lock password | View Lock Pw | Password | 0-9999 | |

* Available on LCD keypad only.

Parameter View Lock Setting Details

| Code | Description |
|---------------------|--|
| CNF-51 View Lock Pw | Register a password to allow access to parameter view lock. Follow the steps below to register a password. |

| Code | Description | |
|----------------------|---|---|
| | No | Procedure |
| | 1 | [PROG/ENT] key on CNF-51 code will show the previous password input window. If registration is made for the first time, enter 0. It is the factory default. |
| | 2 | If a password had been set, enter the saved password. |
| | 3 | If the entered password matches the saved password, a new window prompting the user to enter a new password will be displayed (the process will not progress to the next stage until the user enters a valid password). |
| | 4 | Register a new password. |
| | 5 | After registration, code CNF-51 will be displayed. |
| CNF-50 View Lock Set | To enable parameter view lock, enter a registered password. [Locked] sign will be displayed on the screen to indicate that parameter view lock is enabled. To disable parameter view lock, re-enter the password. The [locked] sign will disappear. | |

5.24 Parameter Lock

Use parameter lock to prevent unauthorized modification of parameter settings. To enable parameter lock, register and enter a user password first.

| Group | Code | Name | LCD Display | Parameter Setting | Setting Range | Unit |
|-------|------|-------------------------|--------------|-------------------|---------------|------|
| dr | 94 | Password registration | - | - | 0-9999 | - |
| | 95 | Parameter lock password | - | - | 0-9999 | - |
| CNF* | 52 | Parameter lock | Key Lock Set | Unlocked | 0-9999 | - |
| | 53 | Parameter lock password | Key Lock PW | Password | 0-9999 | - |

*Available on LCD keypad only.

Parameter Lock Setting Details

| Code | Description | |
|--------------------|--|---|
| CNF-53 Key Lock Pw | Register a password to prohibit parameter modifications. Follow the procedures below to register a password. | |
| | No | Procedures |
| | 1 | Press the [PROG/ENT] key on CNF-53 code and the saved password input window will be displayed. If password registration is being made for the first time, enter 0. It is the factory default. |
| | 2 | If a saved password has been set, enter the saved password. |

| Code | Description | |
|---------------------|---|--|
| | 3 | If the entered password matches the saved password, then a new window to enter a new password will be displayed. (The process will not move to next stage until the user enters a valid password). |
| | 4 | Register a new password. |
| | 5 | After registration, Code CNF-51 will be displayed. |
| CNF-52 Key Lock Set | To enable parameter lock, enter the registered password. [Locked] sign will be displayed on the screen to indicate that prohibition is enabled. Once enabled, Pressing the [PROG/ENT] key on function code will not allow the display edit mode to run. To disable parameter modification prohibition, re-enter the password. The [Locked] sign will disappear. | |

⚠ Caution

If parameter view lock and parameter lock functions are enabled, no inverter operation related function changes can be made. It is very important that you memorize the password.

5.25 Changed Parameter Display

This feature displays all the parameters that are different from the factory defaults. Use this feature to track changed parameters.

| Group | Code | Name | LCD Display | Parameter Setting | Setting Range | Unit |
|-------|------|---------------------------|--------------|-------------------|---------------|------|
| CNF* | 41 | Changed parameter display | Changed Para | 0 View All | - | - |

* Available on LCD keypad only.

Changed Parameter Display Setting Details

| Code | Description | | |
|---------------------|-------------|--------------|---------------------------------|
| CNF-41 Changed Para | Setting | Function | |
| | 0 | View All | Display all parameters |
| | 1 | View Changed | Display changed parameters only |





5.26 User Group

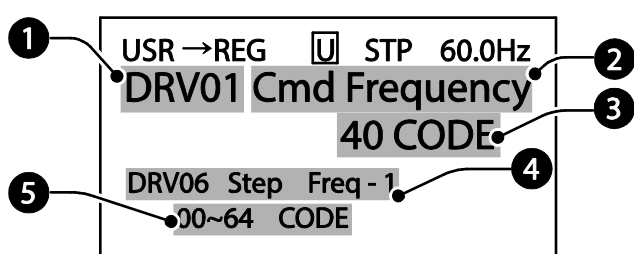

Create a user defined group and register user-selected parameters from the existing function groups. The user group can carry up to a maximum of 64 parameter registrations.

| Group | Code | Name | LCD Display | Parameter Setting | Setting Range | Unit |
|-------|------|----------------------------------|----------------|-------------------|----------------|------|
| CNF* | 42 | Multi-function key settings | Multi Key Sel | 3 | UserGrp SelKey | - |
| | 45 | Delete all user registered codes | UserGrp AllDel | 0 | No | - |

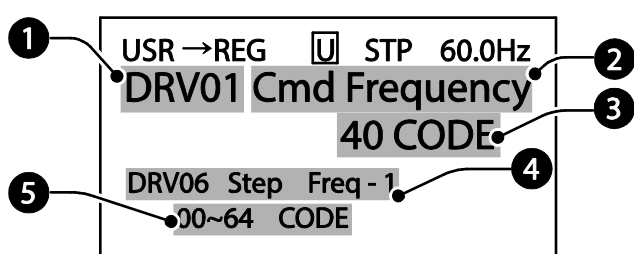
* Available on LCD keypad only.

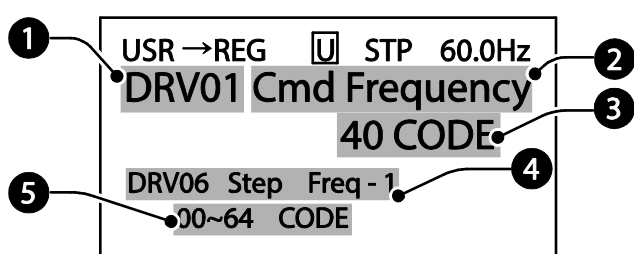
User Group Setting Details

| Code | Description | | | | | | | | | | |
|----------------------|--|---|-----------|---|---|---|---|---|--|---|--|
| CNF-42 Multi-Key Sel | <p>Select 3(UserGrp SelKey) from the multi-function key setting options. If user group parameters are not registered, setting the multi-function key to the user group select key (UserGrp SelKey) will not display user group (USR Grp) item on the Keypad.</p> <p>Follow the procedures below to register parameters to a user group.</p> <table border="1"> <thead> <tr> <th>No</th> <th>Procedure</th> </tr> </thead> <tbody> <tr> <td>1</td> <td>Set CNF- 42 to 3(UserGrp SelKey). A  icon will be displayed at the top of the LCD display.</td> </tr> <tr> <td>2</td> <td>In the parameter mode (PAR Mode), move to the parameter you need to register and press the [MULTI] key. For example, if the [MULTI] key is pressed in the frequency reference in DRV 01 (Cmd Frequency), the screen below will be displayed. <div style="text-align: center;">  </div> <ul style="list-style-type: none"> ① Group name and code number of the parameter ② Name of the parameter ③ Code number to be used in the user group. Pressing the [PROG/ENT] key on the code number (40 Code) will register DRV-01 as code 40 in the user group. ④ Existing parameter registered as the user group code 40 ⑤ Setting range of the user group code. Entering 0 cancels the settings. </td> </tr> <tr> <td>3</td> <td>Set a code number (③) to use to register the parameter in the user group. Select code number and press [PROG/ENT] key.</td> </tr> <tr> <td>4</td> <td>Changing the value in ③ will also change the value in ④. If no</td> </tr> </tbody> </table> | No | Procedure | 1 | Set CNF- 42 to 3(UserGrp SelKey). A  icon will be displayed at the top of the LCD display. | 2 | In the parameter mode (PAR Mode), move to the parameter you need to register and press the [MULTI] key. For example, if the [MULTI] key is pressed in the frequency reference in DRV 01 (Cmd Frequency), the screen below will be displayed. <div style="text-align: center;">  </div> <ul style="list-style-type: none"> ① Group name and code number of the parameter ② Name of the parameter ③ Code number to be used in the user group. Pressing the [PROG/ENT] key on the code number (40 Code) will register DRV-01 as code 40 in the user group. ④ Existing parameter registered as the user group code 40 ⑤ Setting range of the user group code. Entering 0 cancels the settings. | 3 | Set a code number (③) to use to register the parameter in the user group. Select code number and press [PROG/ENT] key. | 4 | Changing the value in ③ will also change the value in ④. If no |
| | No | Procedure | | | | | | | | | |
| | 1 | Set CNF- 42 to 3(UserGrp SelKey). A  icon will be displayed at the top of the LCD display. | | | | | | | | | |
| | 2 | In the parameter mode (PAR Mode), move to the parameter you need to register and press the [MULTI] key. For example, if the [MULTI] key is pressed in the frequency reference in DRV 01 (Cmd Frequency), the screen below will be displayed. <div style="text-align: center;">  </div> <ul style="list-style-type: none"> ① Group name and code number of the parameter ② Name of the parameter ③ Code number to be used in the user group. Pressing the [PROG/ENT] key on the code number (40 Code) will register DRV-01 as code 40 in the user group. ④ Existing parameter registered as the user group code 40 ⑤ Setting range of the user group code. Entering 0 cancels the settings. | | | | | | | | | |
| | 3 | Set a code number (③) to use to register the parameter in the user group. Select code number and press [PROG/ENT] key. | | | | | | | | | |
| 4 | Changing the value in ③ will also change the value in ④. If no | | | | | | | | | | |

| Code | Description | | | | | | | | | | | | |
|-----------------------|---|-----|----------|---|---|---|--|---|------------------------|---|--|---|---------------------|
| | code is registered, 'Empty Code' will be displayed. Entering 0 cancels the settings. | | | | | | | | | | | | |
| 5 | The registered parameters are listed in the user group in U&M mode. You can register one parameter multiple times if necessary. For example, a parameter can be registered as code 2, code 11, and more in the user group. | | | | | | | | | | | | |
| | Follow the procedures below to delete parameters in the user group. | | | | | | | | | | | | |
| | <table border="1"> <thead> <tr> <th>No.</th> <th>Settings</th> </tr> </thead> <tbody> <tr> <td>1</td> <td>Set CNF- 42 to 3(UserGrp SelKey). A  icon will be displayed at the top of the LCD display.</td> </tr> <tr> <td>2</td> <td>In the USR group in U&M mode, move the cursor to the code that is to be deleted.</td> </tr> <tr> <td>3</td> <td>Press the [MULTI] key.</td> </tr> <tr> <td>4</td> <td>Move to YES on the deletion confirmation screen, and press the [PROG/ENT] key.</td> </tr> <tr> <td>5</td> <td>Deletion completed.</td> </tr> </tbody> </table> | No. | Settings | 1 | Set CNF- 42 to 3(UserGrp SelKey). A  icon will be displayed at the top of the LCD display. | 2 | In the USR group in U&M mode, move the cursor to the code that is to be deleted. | 3 | Press the [MULTI] key. | 4 | Move to YES on the deletion confirmation screen, and press the [PROG/ENT] key. | 5 | Deletion completed. |
| No. | Settings | | | | | | | | | | | | |
| 1 | Set CNF- 42 to 3(UserGrp SelKey). A  icon will be displayed at the top of the LCD display. | | | | | | | | | | | | |
| 2 | In the USR group in U&M mode, move the cursor to the code that is to be deleted. | | | | | | | | | | | | |
| 3 | Press the [MULTI] key. | | | | | | | | | | | | |
| 4 | Move to YES on the deletion confirmation screen, and press the [PROG/ENT] key. | | | | | | | | | | | | |
| 5 | Deletion completed. | | | | | | | | | | | | |
| CNF-25 UserGrp AllDel | Set to 1(Yes) to delete all registered parameters in the user group. | | | | | | | | | | | | |

5.27 Easy Start On

Run Easy Start On to easily setup the basic motor parameters required to operate a motor in a batch. Set CNF-61(Easy Start On) to 1(Yes) to activate the feature, initialize all parameters by setting CNF-40 (Parameter Init) to 1 (All Grp), and restart the inverter to activate Easy Start On.

| Group | Code | Name | LCD Display | Parameter Setting | Setting Range | Unit |
|-------|------|-------------------------------|---------------|-------------------|---------------|------|
| CNF* | 61 | Parameter easy start settings | Easy Start On | 1 | Yes | - |

*Available on LCD keypad only.

Easy Start On Setting Details

| Code | Description | | | | | | | | |
|----------------------|---|----|------------|---|---------------------------------------|---|--|---|--|
| | Follow the procedures listed below to set parameter easy start. | | | | | | | | |
| | <table border="1"> <thead> <tr> <th>No</th> <th>Procedures</th> </tr> </thead> <tbody> <tr> <td>1</td> <td>Set CNF-61 (Easy Start On) to 1(Yes).</td> </tr> <tr> <td>2</td> <td>Select 1(All Grp) in CNF-40 (Parameter Init) to initialize all parameters in the inverter.</td> </tr> <tr> <td>3</td> <td>Restarting the inverter will activate the Easy Start On. Set the values in the following screens on the LCD keypad. To escape from the Easy Start On, press the [ESC] key.</td> </tr> </tbody> </table> | No | Procedures | 1 | Set CNF-61 (Easy Start On) to 1(Yes). | 2 | Select 1(All Grp) in CNF-40 (Parameter Init) to initialize all parameters in the inverter. | 3 | Restarting the inverter will activate the Easy Start On. Set the values in the following screens on the LCD keypad. To escape from the Easy Start On, press the [ESC] key. |
| No | Procedures | | | | | | | | |
| 1 | Set CNF-61 (Easy Start On) to 1(Yes). | | | | | | | | |
| 2 | Select 1(All Grp) in CNF-40 (Parameter Init) to initialize all parameters in the inverter. | | | | | | | | |
| 3 | Restarting the inverter will activate the Easy Start On. Set the values in the following screens on the LCD keypad. To escape from the Easy Start On, press the [ESC] key. | | | | | | | | |
| CNF-61 Easy Start On | | | | | | | | | |

| Code | Description |
|------|---|
| | <ul style="list-style-type: none"> • Start Easy Set: Select Yes. • DRV-14 Motor Capacity: Set motor capacity. • BAS-11 Pole Number: Set motor pole number. • BAS-15 Rated Volt: Set motor rated voltage. • BAS-10 60/50Hz Sel: Set motor rated frequency. • BAS-19 AC Input Volt: Set input voltage. • DRV-06 Cmd Source: Set command source. • DRV-01 Cmd Frequency: Set operation frequency. <p>When the settings are completed, the minimum parameter setting on the motor has been made. The LCD keypad will return to a monitoring display. Now the motor can be operated with the command source set at DRV-06.</p> |

5.28 Config(CNF) Mode

The config mode parameters are used to configure the LCD keypad related features.

| Group | Code | Name | LCD Display | Parameter Setting | Setting Range | Unit |
|-------|-------|--|----------------|-------------------|---------------|------|
| CNF* | 2 | LCD brightness/contrast adjustment | LCD Contrast | - | - | |
| | 10 | Inverter S/W version | Inv S/W Ver | x.xx | - | |
| | 11 | Keypad S/W version | Keypad S/W Ver | x.xx | - | - |
| | 12 | Keypad title version | KPD Title Ver | x.xx | - | - |
| | 30-32 | Power slot type | Option-x Type | None | - | - |
| | 44 | Erase trip history | Erase All Trip | No | - | - |
| | 60 | Add title update | Add Title Up | No | - | - |
| | 62 | Initialize accumulated electric energy | WH Count Reset | No | - | - |

* Available on the LCD keypad only.

Config Mode Parameter Setting Details

| Code | Description |
|--|---|
| CNF-2 LCD contrast | Adjusts LCD brightness/contrast on the LCD keypad. |
| CNF-10 Inv S/W Ver, CNF-11 Keypad S/W Ver | Check OS version in the inverter and on the LCD keypad. |

| Code | Description |
|-------------------------|--|
| CNF-12 KPD title Ver | Checks title version on the LCD keypad. |
| CNF-30–32 Option-x type | Checks type of powerboard installed in 1-3 power slot. |
| CNF-44 Erase all trip | Deletes stored trip history. |
| CNF-60 Add Title Up | When inverter SW version is updated and more code is added, CNF-60 settings will add, display, and operate the added codes. Set CNF-60 to 1 (Yes) and disconnect the LCD keypad from the inverter. Reconnecting the LCD keypad to the inverter updates titles. |
| CNF-62 WH Count Reset | Initialize accumulated electric energy consumption count. |

5.29 Timer Settings

Set a multi-function input terminal to a timer and On/Off control the multi-function output and relay according to the timer settings.

| Group | Code | Name | LCD Display | Parameter Setting | | Setting Range | Unit |
|-------|-------|---------------------------|----------------------|-------------------|-----------|---------------|------|
| In | 65–71 | Px terminal configuration | Px Define(Px: P1–P7) | 38 | Timer In | - | - |
| OU | 31 | Multi-function relay1 | Relay 1 | 28 | Timer Out | - | - |
| | 33 | Multi-function output1 | Q1 Define | | | | |
| | 55 | Timer on delay | Timer on delay | 3.00 | | 0.00–100 | sec |
| | 56 | Timer off delay | Timer off delay | 1.00 | | 0.00–100 | sec |

Timer Setting Details

| Code | Description |
|---|--|
| In.65-71 Px Define | Choose one of the multi-function input terminals and change it to a timer terminal by setting it to 38 (Timer In). |
| OU.31 Relay1, OU.33 Q1 Define | Set multi-function output terminal or relay to be used as a timer to 28 (Timer out). |
| OU.55 TimerOn Delay, OU.56 TimerOff Delay | Input a signal (On) to the timer terminal to operate a timer output (Timer out) after the time set at OU.55 has passed. When the multi-function input terminal is off, multi-function output or relay turns off after the time set at OU.56. |

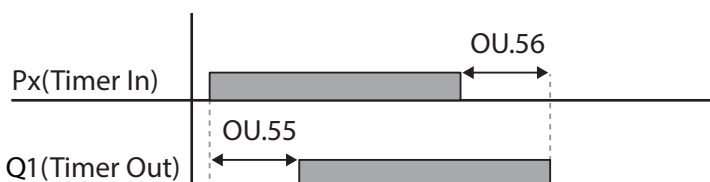

5.30 Brake Control

Brake control is used to control the On/Off operation of electronic brake load system.

| Group | Code | Name | LCD Display | Parameter Setting | | Setting Range | Unit |
|-------|------|------------------------------|---------------|-------------------|-------------|---------------------|------|
| dr | 09 | Control mode | Control Mode | 0 | V/F | - | - |
| Ad | 41 | Brake open current | BR Rls Curr | 50.0 | | 0.0–180% | % |
| | 42 | Brake open delay time | BR Rls Dly | 1.00 | | 0.0–10.0 | sec |
| | 44 | Brake open forward frequency | BR Rls Fwd Fr | 1.00 | | 0–Maximum frequency | Hz |
| | 45 | Brake open reverse frequency | BR Rls Rev Fr | 1.00 | | 0–Maximum frequency | Hz |
| | 46 | Brake close delay time | BR Eng Dly | 1.00 | | 0.00–10.00 | sec |
| | 47 | Brake close frequency | BR Eng Fr | 2.00 | | 0–Maximum frequency | Hz |
| OU | 31 | Multi-function relay1 item | Relay 1 | 35 | BR Control: | - | - |
| | 33 | Multi-function output1 item | Q1 Define | | | | |

When brake control is activated, DC braking (Ad.12) at inverter start and dwell operation (Ad.20-23) do not operate.

- **Brake release sequence:** During motor stop state, if an operation command is entered, the inverter accelerates up to brake release frequency (Ad.44- 45) in forward or in reverse direction. After reaching brake release frequency, if motor current reaches brake release current (BR Rls Curr), the output relay or multi function output terminal for brake control sends a release signal. Once the signal has been sent, acceleration will begin after maintaining frequency for brake release delay time (BR Rls Dly).
- **Brake engage sequence:** If a stop command is sent during operation, the motor decelerates. Once the output frequency reaches brake engage frequency (BR Eng Fr), the motor stops deceleration and sends out a brake engage signal to a preset output terminal. Frequency is maintained for the brake engage delay time (BR Eng Dly) and will become 0 afterwards. If DC braking time (Ad.15) and DC braking resistance (Ad.16) are set, inverter output is blocked after DC braking. For DC braking, refer to [4.17.2 Stop After DC Braking](#) on page [101](#).

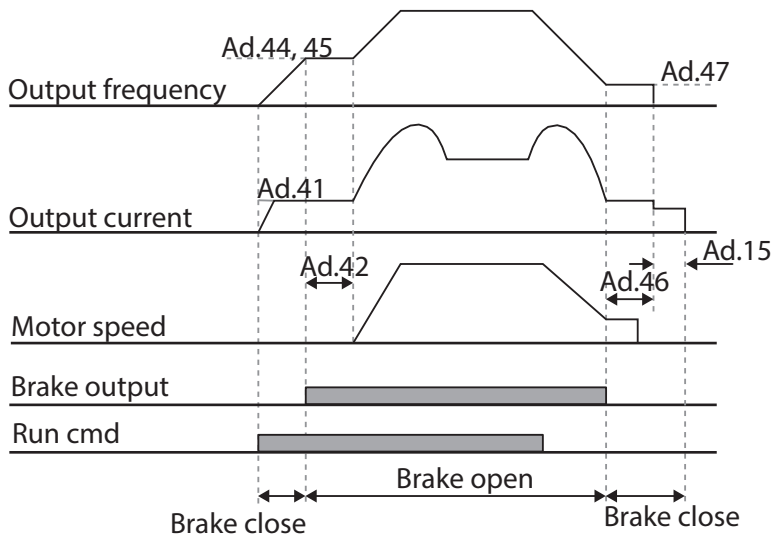

5.31 Multi-Function Output On/Off Control

Set reference values (on/off level) for analog input and control output relay or multi-function output terminal on/off status accordingly.

| Group | Code | Name | LCD Display | Parameter Setting | Setting Range | Unit |
|-------|------|-------------------------------------|-----------------|-------------------|------------------------------------|------|
| Ad | 66 | Output terminal on/off control mode | On/Off Ctrl Src | 1 V1 | - | - |
| | 67 | Output terminal on level | On-C Level | 90.00 | Output terminal off level- 100.00% | % |
| | 68 | Output terminal off level | Off-C Level | 10.00 | 0.00-Output terminal on level | % |
| OU | 31 | Multi-function relay1 item | Relay 1 | 34 On/Off | - | - |
| | 33 | Multi-function output1 item | Q1 Define | | | |

Multi-function Output On/Off Control Setting Details

| Code | Description |
|--------------------------------------|--|
| Ad.66 On/Off Ctrl Src | Select analog input On/Off control. |
| Ad.67 On-C Level , Ad.68 Off-C Level | Set On/Off level at the output terminal. |

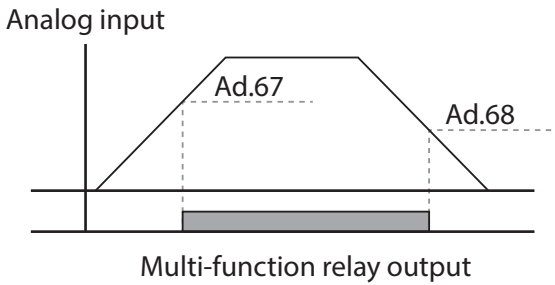

5.32 Press Regeneration Prevention

Press regeneration prevention is used during press operations to prevent braking during the regeneration process. If motor regeneration occurs during a press operation, motor operation speed automatically goes up to avoid the regeneration zone.

| Group | Code | Name | LCD Display | Parameter Setting | | Setting Range | Unit |
|-------|--------------------------------------|--|----------------|-------------------|------------|----------------|------|
| Ad | 74 | Select press regeneration prevention for press | RegenAvd Sel | 0 | No | 0-1 | - |
| | 75 | Press regeneration prevention operation voltage level | RegenAvd Level | 350V | | 200V: 300-400V | V |
| | | | | 700V | | 400V: 600-800V | |
| | 76 | Press regeneration prevention compensation frequency limit | CompFreq Limit | 1.00(Hz) | | 0.00- 10.00Hz | Hz |
| | 77 | Press regeneration prevention P gain | RegenAvd Pgain | 50.0(%) | | 0.0- 100.0% | % |
| 78 | Press regeneration prevention I gain | RegenAvd Igain | 500(ms) | | 20-30000ms | ms | |

Press Regeneration Prevention Setting Details

| Code | Description |
|----------------------|--|
| Ad.74 RegenAvd Sel | Frequent regeneration voltage from a press load during constant speed motor operation may force excessive work on the brake unit which may damage or shorten the brake life. To prevent this situation, select Ad.74 (RegenAvd Sel) to control DC link voltage and disable the brake unit operation. |
| Ad.75 RegenAvd Level | Set brake operation prevention level voltage when the DC link voltage goes up due to regeneration. |

| Code | Description |
|---|---|
| Ad.76 CompFreq Limit | Set alternative frequency width that can replace actual operation frequency during regeneration prevention. |
| Ad.77 RegenAvd Pgain, Ad.78 RegenAvd Igain | To prevent regeneration zone, set P gain/I gain in the DC link voltage suppress PI controller. |

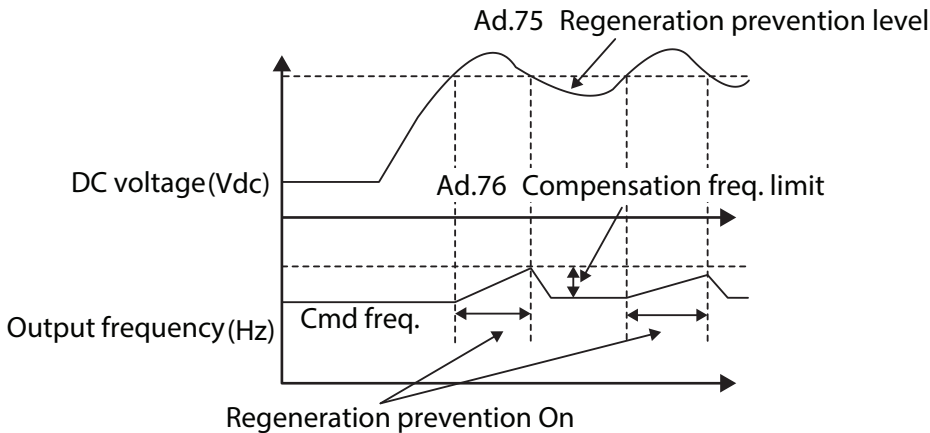

Note

Press regeneration prevention does not operate during accelerations or decelerations, but it only operates during constant speed motor operation. When regeneration prevention is activated, output frequency may change within the range set at Ad.76 (CompFreq Limit).

5.33 Analog Output

An analog output terminal provides output of 0-10V voltage, 4-20mA current, or 0-32kHz pulse.

5.33.1 Voltage and Current Analog Output

An output size can be adjusted by selecting an output option at AO(Analog Output) terminal. Set the analog voltage/current output terminal setting switch (SW3) to change the output type (voltage/current).

| Group | Code | Name | LCD Display | Parameter Setting | Setting Range | Unit | |
|-------|------|---------------------|-------------|-------------------|---------------|----------------|---|
| OU | 01 | Analog output1 | AO1 Mode | 0 | Frequency | 0-15 | - |
| | 02 | Analog output1 gain | AO1 Gain | 100.0 | | -1000.0-1000.0 | % |
| | 03 | Analog output1 bias | AO1 Bias | 0.0 | | -100.0-100.0 | % |

| Group | Code | Name | LCD Display | Parameter Setting | Setting Range | Unit |
|-------|------|-------------------------|-------------|-------------------|---------------|------|
| | 04 | Analog output1 filter | AO1 Filter | 5 | 0-10000 | ms |
| | 05 | Analog constant output1 | AO1 Const % | 0.0 | 0.0-100.0 | % |
| | 06 | Analog output1 monitor | AO1 Monitor | 0.0 | 0.0-1000.0 | % |

Voltage and Current Analog Output Setting Details

| Code | Description | | | | | | | | | | | | | | | | | | | | | | |
|----------------|--|--|----------|---|--|---|--|---|--|---|---|---|--|---|--|---|---|---|---|---|---|---|--|
| OU.01 AO1 Mode | Select a constant value for output. The following example for output voltage setting. | | | | | | | | | | | | | | | | | | | | | | |
| | <table border="1"> <thead> <tr> <th>Setting</th> <th>Function</th> </tr> </thead> <tbody> <tr> <td>0</td> <td>Frequency Outputs operation frequency as a standard. 10V output is made from the frequency set at dr.20(Max Freq)</td> </tr> <tr> <td>1</td> <td>Output Current 10V output is made from 200% of inverter rated current (heavy load).</td> </tr> <tr> <td>2</td> <td>Output Voltage Sets the outputs based on the inverter output voltage. 10V output is made from a set voltage in bA.15 (Rated V). If 0V is set in bA.15, 200V/400V models output 10V based on the actual input voltages (240V and 480V respectively).</td> </tr> <tr> <td>3</td> <td>DC Link Volt Outputs inverter DC link voltage as a standard. Outputs 10V when the DC link voltage is 410Vdc for 200V models, and 820Vdc for 400V models.</td> </tr> <tr> <td>4</td> <td>Torque Outputs the generated torque as a standard. Outputs 10V at 250% of motor rated torque.</td> </tr> <tr> <td>5</td> <td>Ouput Power Monitors output wattage. 200% of rated output is the maximum display voltage (10V).</td> </tr> <tr> <td>6</td> <td>Idse Outputs the maximum voltage at 200% of no load current.</td> </tr> <tr> <td>7</td> <td>Iqse Outputs the maximum voltage at 250% of rated torque current $= \sqrt{\text{rated curre}^2 - \text{no load current}^2}$ </td> </tr> <tr> <td>8</td> <td>Target Freq Outputs set frequency as a standard. Outputs 10V at the maximum frequency (dr.20).</td> </tr> <tr> <td>9</td> <td>Ramp Freq Outputs frequency calculated with Acc/Dec function as a standard. May vary with actual output frequency. Outputs 10V.</td> </tr> </tbody> </table> | Setting | Function | 0 | Frequency Outputs operation frequency as a standard. 10V output is made from the frequency set at dr.20(Max Freq) | 1 | Output Current 10V output is made from 200% of inverter rated current (heavy load). | 2 | Output Voltage Sets the outputs based on the inverter output voltage. 10V output is made from a set voltage in bA.15 (Rated V). If 0V is set in bA.15, 200V/400V models output 10V based on the actual input voltages (240V and 480V respectively). | 3 | DC Link Volt Outputs inverter DC link voltage as a standard. Outputs 10V when the DC link voltage is 410Vdc for 200V models, and 820Vdc for 400V models. | 4 | Torque Outputs the generated torque as a standard. Outputs 10V at 250% of motor rated torque. | 5 | Ouput Power Monitors output wattage. 200% of rated output is the maximum display voltage (10V). | 6 | Idse Outputs the maximum voltage at 200% of no load current. | 7 | Iqse Outputs the maximum voltage at 250% of rated torque current $= \sqrt{\text{rated curre}^2 - \text{no load current}^2}$ | 8 | Target Freq Outputs set frequency as a standard. Outputs 10V at the maximum frequency (dr.20). | 9 | Ramp Freq Outputs frequency calculated with Acc/Dec function as a standard. May vary with actual output frequency. Outputs 10V. |
| | Setting | Function | | | | | | | | | | | | | | | | | | | | | |
| | 0 | Frequency Outputs operation frequency as a standard. 10V output is made from the frequency set at dr.20(Max Freq) | | | | | | | | | | | | | | | | | | | | | |
| | 1 | Output Current 10V output is made from 200% of inverter rated current (heavy load). | | | | | | | | | | | | | | | | | | | | | |
| | 2 | Output Voltage Sets the outputs based on the inverter output voltage. 10V output is made from a set voltage in bA.15 (Rated V). If 0V is set in bA.15, 200V/400V models output 10V based on the actual input voltages (240V and 480V respectively). | | | | | | | | | | | | | | | | | | | | | |
| | 3 | DC Link Volt Outputs inverter DC link voltage as a standard. Outputs 10V when the DC link voltage is 410Vdc for 200V models, and 820Vdc for 400V models. | | | | | | | | | | | | | | | | | | | | | |
| | 4 | Torque Outputs the generated torque as a standard. Outputs 10V at 250% of motor rated torque. | | | | | | | | | | | | | | | | | | | | | |
| | 5 | Ouput Power Monitors output wattage. 200% of rated output is the maximum display voltage (10V). | | | | | | | | | | | | | | | | | | | | | |
| | 6 | Idse Outputs the maximum voltage at 200% of no load current. | | | | | | | | | | | | | | | | | | | | | |
| 7 | Iqse Outputs the maximum voltage at 250% of rated torque current $= \sqrt{\text{rated curre}^2 - \text{no load current}^2}$ | | | | | | | | | | | | | | | | | | | | | | |
| 8 | Target Freq Outputs set frequency as a standard. Outputs 10V at the maximum frequency (dr.20). | | | | | | | | | | | | | | | | | | | | | | |
| 9 | Ramp Freq Outputs frequency calculated with Acc/Dec function as a standard. May vary with actual output frequency. Outputs 10V. | | | | | | | | | | | | | | | | | | | | | | |

| Code | Description | | | | | | | | | | | | | | | |
|-----------------------------------|---|--|--------------|--|----|---------------|--|--------------------------|------------|--|-------------------------|----------|--|-------|--|--|
| | <table border="1"> <tr> <td>12</td> <td>PID RefValue</td> <td>Outputs command value of a PID controller as a standard. Outputs approximately 6.6V at 100%.</td> </tr> <tr> <td>13</td> <td>PID Fdk Value</td> <td>Outputs feedback volume of a PID controller as a standard. Outputs approximately 6.6V at 100%.</td> </tr> <tr> <td>14</td> <td>PID Output</td> <td>Outputs output value of a PID controller as a standard. Outputs approximately 10V at 100%.</td> </tr> <tr> <td>15</td> <td>Constant</td> <td>Outputs OU.05 (AO1 Const %) value as a standard.</td> </tr> </table> | 12 | PID RefValue | Outputs command value of a PID controller as a standard. Outputs approximately 6.6V at 100%. | 13 | PID Fdk Value | Outputs feedback volume of a PID controller as a standard. Outputs approximately 6.6V at 100%. | 14 | PID Output | Outputs output value of a PID controller as a standard. Outputs approximately 10V at 100%. | 15 | Constant | Outputs OU.05 (AO1 Const %) value as a standard. | | | |
| 12 | PID RefValue | Outputs command value of a PID controller as a standard. Outputs approximately 6.6V at 100%. | | | | | | | | | | | | | | |
| 13 | PID Fdk Value | Outputs feedback volume of a PID controller as a standard. Outputs approximately 6.6V at 100%. | | | | | | | | | | | | | | |
| 14 | PID Output | Outputs output value of a PID controller as a standard. Outputs approximately 10V at 100%. | | | | | | | | | | | | | | |
| 15 | Constant | Outputs OU.05 (AO1 Const %) value as a standard. | | | | | | | | | | | | | | |
| OU.02 AO1 Gain, OU.03 AO1 Bias | <p>Adjusts output value and offset. If frequency is selected as an output item, it will operate as shown below.</p> $AO1 = \frac{Frequency}{MaxFreq} \times AO1\ Gain + AO1\ Bias$ <p>The graph below illustrates the analog voltage output (AO1) changes depend on OU.02 (AO1 Gain) and OU.03 (AO1 Bias) values. Y-axis is analog output voltage (0-10V), and X-axis is % value of the output item.</p> <p>Example, if the maximum frequency set at dr.20 (Max Freq) is 60Hz and the present output frequency is 30Hz, then the x-axis value on the next graph is 50%.</p> <table border="1"> <thead> <tr> <th colspan="2"></th> <th colspan="2">OU.02 AO1 Gain</th> </tr> <tr> <th colspan="2"></th> <th>100.0% (Factory default)</th> <th>80.0%</th> </tr> </thead> <tbody> <tr> <th rowspan="2">OU.03 AO1 Bias</th> <th>0.0% Factory default</th> <td> </td> <td> </td> </tr> <tr> <th>20.0%</th> <td> </td> <td> </td> </tr> </tbody> </table> | | | OU.02 AO1 Gain | | | | 100.0% (Factory default) | 80.0% | OU.03 AO1 Bias | 0.0% Factory default | | | 20.0% | | |
| | | OU.02 AO1 Gain | | | | | | | | | | | | | | |
| | | 100.0% (Factory default) | 80.0% | | | | | | | | | | | | | |
| OU.03 AO1 Bias | 0.0% Factory default | | | | | | | | | | | | | | | |
| | 20.0% | | | | | | | | | | | | | | | |
| OU.04 AO1 Filter | Set filter time constant on analog output. | | | | | | | | | | | | | | | |
| OU.05 AO1 Const % | If analog output at OU.01 (AO1 Mode) is set to 15(Constant), the analog voltage output is dependent on the set parameter values (0-100%). | | | | | | | | | | | | | | | |
| OU.06 AO1 Monitor | Monitors analog output value. Displays the maximum output voltage as a percentage (%) with 10V as the standard. | | | | | | | | | | | | | | | |

5.33.2 Analog Pulse Output

Output item selection and pulse size adjustment can be made for the TO (Pulse Output) terminal.

| Group | Code | Name | LCD Display | Parameter Setting | Setting Range | Unit |
|-------|------|-------------------------------|-------------|-------------------|----------------|------|
| OU | 33 | Multi-function output 1 | Q1 define | 39 TO | 0-38 | - |
| | 61 | Pulse output setting | TO Mode | 0 Frequency | 0-15 | - |
| | 62 | Pulse output gain | TO Gain | 100.0 | -1000.0-1000.0 | % |
| | 63 | Pulse output bias | TO Bias | 0.0 | -100.0-100.0 | % |
| | 64 | Pulse output filter | TO Filter | 5 | 0-10000 | ms |
| | 65 | Pulse output constant output2 | TO Const % | 0.0 | 0.0-100.0 | % |
| | 66 | Pulse output monitor | TO Monitor | 0.0 | 0.0-1000.0 | % |

Analog Pulse Output Setting Details

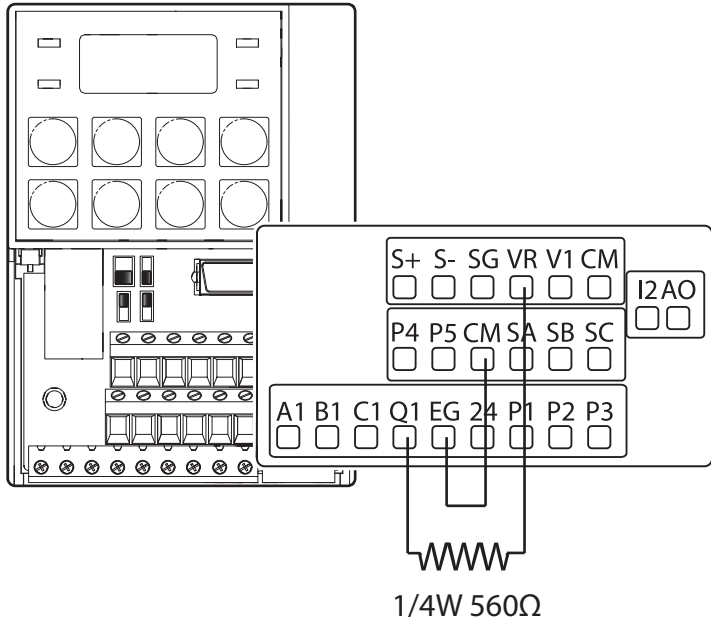
| Code | Description |
|-----------------|--|
| OU.33 Q1 Define | <p>In case of Standard I/O, pulse output TO and multi-function output Q1 share the same terminal. Set OU.33 to 32kHz pulse output and follow the instructions below to make wiring connections that configure the open collector output circuit.</p> <ol style="list-style-type: none"> 1. Connect a 1/4W, 560Ω resistor between VR and Q1 terminals. 2. Connect EG and CM terminals. <p>When wiring the resistor, a resistance of 560Ω or less is recommended to stably provide 32kHz pulse output.</p>  <p>The diagram shows a terminal block with terminals labeled S+, S-, SG, VR, V1, CM, P4, P5, CM, SA, SB, SC, A1, B1, C1, Q1, EG, 24, P1, P2, P3. A resistor is connected between VR and Q1. EG and CM are also connected.</p> <p>When connecting to a pulse between the S100 inverters, please connect pulse output(Q1-EG) to pulse input(TI-CM) directly without resistor and wire.</p> |

| Code | Description | | | | | | | | | | | | | | | |
|---------------------------------|--|-------------------------|---------------|---------------|--|--|--|-------------------------|-------|---------------|-------------------------|--|--|-------|--|--|
| OU.62 TO Gain, OU.63 TO Bias | <p>Adjusts output value and offset. If frequency is selected as an output, it will operate as shown below.</p> $TO = \frac{Frequency}{MaxFreq} \times TO\ Gain + TO\ Bias$ <p>The following graph illustrates that the pulse output (TO) changes depend on OU.62 (TO Gain) and OU.63 (TO Bias) values. The Y-axis is an analog output current(0-32kHz), and X-axis is % value on output item.</p> <p>For example, if the maximum frequency set with dr.20 (Max Freq) is 60Hz and present output frequency is 30Hz, then the x-axis value on the next graph is 50%.</p> <div style="text-align: center;"> <table border="1" data-bbox="358 710 1085 1244"> <thead> <tr> <th colspan="2"></th> <th colspan="2">OU.62 TO Gain</th> </tr> <tr> <th colspan="2"></th> <th>100.0%(Factory default)</th> <th>80.0%</th> </tr> </thead> <tbody> <tr> <th rowspan="2">OU.63 TO Bias</th> <th>0.0% Factory default</th> <td data-bbox="436 788 797 1020"> </td> <td data-bbox="797 788 1081 1020"> </td> </tr> <tr> <th>20.0%</th> <td data-bbox="436 1020 797 1244"> </td> <td data-bbox="797 1020 1081 1244"> </td> </tr> </tbody> </table> </div> | | | OU.62 TO Gain | | | | 100.0%(Factory default) | 80.0% | OU.63 TO Bias | 0.0% Factory default | | | 20.0% | | |
| | | | OU.62 TO Gain | | | | | | | | | | | | | |
| | | 100.0%(Factory default) | 80.0% | | | | | | | | | | | | | |
| OU.63 TO Bias | 0.0% Factory default | | | | | | | | | | | | | | | |
| | 20.0% | | | | | | | | | | | | | | | |
| OU.64 TO Filter | Sets filter time constant on analog output. | | | | | | | | | | | | | | | |
| OU.65 TO Const % | If analog output item is set to constant, the analog pulse output is dependent on the set parameter values. | | | | | | | | | | | | | | | |
| OU.66 TO Monitor | Monitors analog output value. Displays the maximum output pulse (32kHz) as a percentage (%) of the standard. | | | | | | | | | | | | | | | |

Note

OU.08 AO2 Gain and OU.09 AO2 Bias Tuning Mode on 4-20mA output

- 1 Set OU.07 (AO2 Mode) to constant, and set OU.11 (AO2 Const %) to 0.0 %.
- 2 Set OU.09 (AO2 Bias) to 20.0% and then check current output. 4mA output should be displayed.
- 3 If the value is less than 4mA, gradually increase OU.09 (AO2 Bias) until 4mA is measured. If the

value is more than 4mA, gradually decrease OU.09 (AO2 Bias) until 4mA is measured.

4 Set OU.11 AO2 Const % to 100.0%

Set OU.08 (AO2 Gain) to 80.0% and measure current output at 20mA. If the value is less than 20mA, gradually increase OU.08 (AO2 Gain) until 20mA is measured. If the value is more than 20mA, gradually decrease OU.08 (AO2 Gain) until 20mA is measured.

The functions for each code are identical to the descriptions for the 0-10V voltage outputs with an output range 4-20mA.

5.34 Digital Output

5.34.1 Multi-function Output Terminal and Relay Settings

| Group | Code | Name | LCD Display | Parameter Setting | Setting Range | Unit |
|-------|-------|--------------------------------|---------------|-------------------|------------------------|------|
| OU | 30 | Fault output item | Trip Out Mode | 010* | - | bit |
| | 31 | Multi-function relay1 setting | Relay 1 | 29 Trip | - | - |
| | 33 | Multi-function output1 setting | Q1 Define | 14 Run | - | - |
| | 41 | Multi-function output monitor | DO Status | - | 00- 11 | bit |
| | 57 | Detection frequency | FDT Frequency | 30.00 | 0.00-Maximum frequency | Hz |
| | 58 | Detection frequency band | FDT Band | 10.00 | | |
| In | 65-71 | Px terminal configuration | Px Define | 16 Exchange | - | - |

*Displayed as  on the keypad.

Multi-function Output Terminal and Relay Setting Details

| Code | Description | | | | |
|-----------------|---|----------|----------|----------|-------------------|
| OU.31 Relay1 | Set relay (Relay 1) output options. | | | | |
| OU.33 Q1 Define | Select output options for multi-function output terminal (Q1). Q1 is open collector TR output. | | | | |
| OU.41 DO Status | Set output terminal and relay functions according to OU.57 FDT (Frequency), OU.58 (FDT Band) settings and fault trip conditions. | | | | |
| | <table border="1"> <thead> <tr> <th>Setting</th> <th>Function</th> </tr> </thead> <tbody> <tr> <td>0 None</td> <td>No output signal.</td> </tr> </tbody> </table> | Setting | Function | 0 None | No output signal. |
| | Setting | Function | | | |
| 0 None | No output signal. | | | | |
| | | | | | |

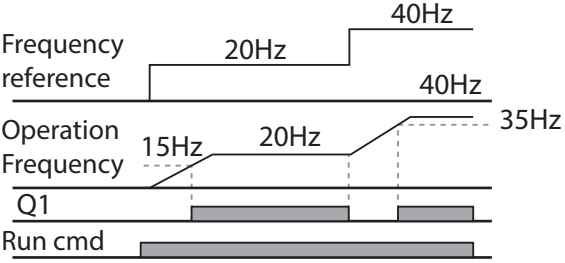
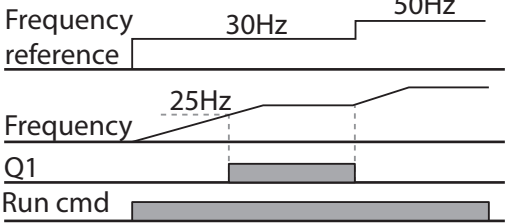
| Code | Description | |
|------|-------------|--|
| 1 | FDT-1 | <p>Detects inverter output frequency reaching the user set frequency. Outputs a signal when the absolute value (set frequency-output frequency) < detected frequency width/2.</p> <p>When detected frequency width is 10Hz, FDT-1 output is as shown in the graph below.</p>  |
| 2 | FDT-2 | <p>Outputs a signal when the user set frequency and detected frequency (FDT Frequency) are equal, and fulfills FDT-1 condition at the same time.</p> <p>[Absolute value (set frequency-detected frequency) < detected frequency width/2]&[FDT-1]</p> <p>Detected frequency width is 10Hz. When the detected frequency is set to 30Hz, FDT-2 output is as shown in the graph below.</p>  |
| 3 | FDT-3 | <p>Outputs a signal when the Absolute value (output frequency-operation frequency) < detected frequency width/2.</p> <p>Detected frequency width is 10Hz. When detected frequency is set to 30Hz, FDT-3 output is as shown in the graph below.</p> |

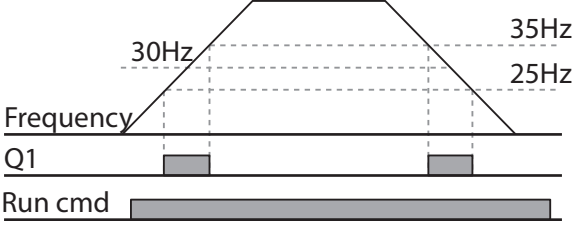
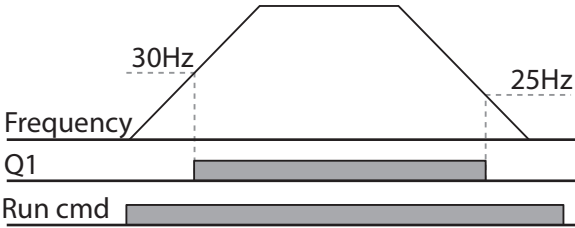
| Code | Description | |
|------|--------------|--|
| | |  |
| 4 | FDT-4 | <p>Output signal can be separately set for acceleration and deceleration conditions.</p> <ul style="list-style-type: none"> • In acceleration: Operation frequency \geq Detected frequency • In deceleration: Operation frequency $>$ (Detected frequency - Detected frequency width / 2) <p>Detected frequency width is 10Hz. When detected frequency is set to 30Hz, FDT-4 output is as shown in the graph below.</p>  |
| 5 | Overload | Outputs a signal at motor overload. |
| 6 | IOL | Outputs a signal when a fault is triggered from a protective function operation by inverter overload inverse proportion. |
| 7 | Underload | Outputs a signal at load fault warning. |
| 8 | Fan Warning | Outputs a signal at fan fault warning. |
| 9 | Stall | Outputs a signal when a motor is overloaded and stalled. |
| 10 | Over voltage | Outputs a signal when the inverter DC link voltage rises above the protective operation voltage. |
| 11 | Low Voltage | Outputs a signal when the inverter DC link voltage drops below the low voltage protective level. |
| 12 | Over Heat | Outputs signal when the inverter overheats. |
| 13 | Lost command | <p>Outputs a signal when there is a loss of analog input terminal and RS-485 communication command at the terminal block.</p> <p>Outputs a signal when communication power and expansion an I/O power card is installed, and also</p> |

| Code | Description | |
|------|----------------|--|
| | | outputs a signal when losing analog input and communication power commands. |
| 14 | RUN | <p>Outputs a signal when operation command is entered and the inverter outputs voltage. No signal output during DC braking.</p> <p>The diagram shows three signals over time. The top signal is 'Frequency', which is a trapezoidal wave. The middle signal is 'Q1', which is a pulse that starts when the frequency begins to rise and ends when the frequency returns to zero. The bottom signal is 'Run cmd', which is a pulse that starts when the frequency begins to rise and ends before the frequency returns to zero.</p> |
| 15 | Stop | Outputs a signal at operation command off, and when there is no inverter output voltage. |
| 16 | Steady | Outputs a signal in steady operation. |
| 17 | Inverter line | Outputs a signal while the motor is driven by the inverter line. |
| 18 | Comm line | Outputs a signal while the motor is driven by a commercial power source. For details, refer to 5.18 Supply Power Transition on page 168 . |
| 19 | Speed search | Outputs a signal during inverter speed search operation. For details, refer to 5.14 Speed Search Operation on page 160 . |
| 22 | Ready | Outputs signal when the inverter is in stand by operation and ready to receive an external operation command. |
| 28 | Timer Out | A timer function to operate terminal output after a certain time by using multi-function terminal block input. For more details, refer to 5.29 Timer Settings on page 178 . |
| 29 | Trip | Outputs a signal after a fault trip Refer to 5.31 Multi-Function Output On/Off Control on page 180 . |
| 31 | DB Warn %ED | Refer to 6.2.5 Dynamic Braking (DB) Resistor Configuration on page 208 . |
| 34 | On/Off Control | Outputs a signal using an analog input value as a standard. Refer to 5.31 Multi-Function Output On/Off Control on page 180 . |
| 35 | BR Control | Outputs a brake release signal. Refer to 5.30 Brake Control on page 179 . |













| Code | Description | |
|------|---------------|---|
| 40 | KEB Operating | This outputs when the energy buffering operation is started because of low voltage of the inverter's DC power section due to a power failure on the input power. (This outputs in the energy buffering state before the input power restoration regardless of KEB-1 and KEB-2 mode settings.) |

5.34.2 Fault Trip Output using Multi-Function Output Terminal and Relay

The inverter can output fault trip state using multi-function output terminal (Q1) and relay (Relay 1).

| Group | Code | Name | LCD Display | Parameter Setting | Setting Range | Unit |
|-------|------|-----------------------------|----------------|-------------------|---------------|------|
| OU | 30 | Fault trip output mode | Trip Out Mode | 010 | - | bit |
| | 31 | Multi-function relay1 | Relay 1 | 29 | Trip | - |
| | 33 | Multi-function output1 | Q1 Define | 14 | Run | - |
| | 53 | Fault trip output on delay | TripOut OnDly | 0.00 | 0.00–100.00 | sec |
| | 54 | Fault trip output off delay | TripOut OffDly | 0.00 | 0.00–100.00 | sec |

Fault Trip Output by Multi-function Output Terminal and Relay - Setting Details

| Code | Description | | | | | | | | | | | | | | | | | | | |
|---|---|---|---|----------|--------|---|---|------------|---|---|---|---|--|---|--|--|---|--|--|--|
| OU.30 Trip Out Mode | Fault trip relay operates based on the fault trip output settings. | | | | | | | | | | | | | | | | | | | |
| | <table border="1"> <thead> <tr> <th>Item</th> <th>bit on</th> <th>bit off</th> </tr> </thead> <tbody> <tr> <td>Keypad</td> <td></td> <td></td> </tr> <tr> <td>LCD keypad</td> <td></td> <td></td> </tr> </tbody> </table> | Item | bit on | bit off | Keypad |  |  | LCD keypad |  |  | | | | | | | | | | |
| | Item | bit on | bit off | | | | | | | | | | | | | | | | | |
| | Keypad |  |  | | | | | | | | | | | | | | | | | |
| | LCD keypad |  |  | | | | | | | | | | | | | | | | | |
| Select fault trip output terminal/relay and select 29(Trip Mode) at codes OU. 31, 33. When a fault trip occurs in the inverter, the relevant terminal and relay will operate. Depending on the fault trip type, terminal and relay operation can be configured as shown in the table below. | | | | | | | | | | | | | | | | | | | | |
| <table border="1"> <thead> <tr> <th colspan="3">Setting</th> <th>Function</th> </tr> <tr> <th>bit3</th> <th>bit2</th> <th>bit1</th> <th></th> </tr> </thead> <tbody> <tr> <td></td> <td></td> <td>✓</td> <td>Operates when low voltage fault trips occur</td> </tr> <tr> <td></td> <td>✓</td> <td></td> <td>Operates when fault trips other than low voltage occur</td> </tr> <tr> <td>✓</td> <td></td> <td></td> <td>Operates when auto restart fails (Pr. 08-09)</td> </tr> </tbody> </table> | Setting | | | Function | bit3 | bit2 | bit1 | | | | ✓ | Operates when low voltage fault trips occur | | ✓ | | Operates when fault trips other than low voltage occur | ✓ | | | Operates when auto restart fails (Pr. 08-09) |
| Setting | | | Function | | | | | | | | | | | | | | | | | |
| bit3 | bit2 | bit1 | | | | | | | | | | | | | | | | | | |
| | | ✓ | Operates when low voltage fault trips occur | | | | | | | | | | | | | | | | | |
| | ✓ | | Operates when fault trips other than low voltage occur | | | | | | | | | | | | | | | | | |
| ✓ | | | Operates when auto restart fails (Pr. 08-09) | | | | | | | | | | | | | | | | | |

| Code | Description |
|---|---|
| OU.31 Relay1 | Set relay output (Relay 1). |
| OU.33 Q1 Define | Select output for multi-function output terminal (Q1). Q1 is open collector TR output. |
| OU.53 TripOut On Dly, OU.54 TripOut OffDly | If a fault trip occurs, trip relay or multi-function output operates after the time delay set in OU.53. Terminal is off with the input initialized after the time delay set in OU.53. |

















5.34.3 Multi-function Output Terminal Delay Time Settings

Set on-delay and off-delay times separately to control the output terminal and relay operation times. The delay time set at codes OU.50-51 applies to multi-function output terminal (Q1) and relay (Relay 1), except when the multi-function output function is in fault trip mode.

| Group | Code | Name | LCD Display | Parameter Setting | Setting Range | Unit |
|-------|------|---------------------------------------|--------------|-------------------|---------------|------|
| OU | 50 | Multi-function output On delay | DO On Delay | 0.00 | 0.00-100.00 | s |
| | 51 | Multi-function output Off delay | DO Off Delay | 0.00 | 0.00-100.00 | s |
| | 52 | Select multi-function output terminal | DO NC/NO Sel | 00* | 00-11 | bit |

* Displayed as  on keypad.

Output Terminal Delay Time Setting Details

| Code | Description | | | | | | | | | |
|--------------------|---|---|---|---------|--------|---|---|------------|---|---|
| OU.52 DO NC/NO Sel | Select terminal type for relay and multi-function output terminal. An additional three terminal type selection bits at the terminal block will be added when an expansion I/O is added. By setting the relevant bit to 0, it will operate A terminal (Normally Open), and setting it to 1 will operate B terminal (Normally Closed). Shown below in the table are Relay 1 and Q1 settings starting from the right bit. | | | | | | | | | |
| | <table border="1"> <thead> <tr> <th>Item</th> <th>bit on</th> <th>bit off</th> </tr> </thead> <tbody> <tr> <td>Keypad</td> <td></td> <td></td> </tr> <tr> <td>LCD keypad</td> <td></td> <td></td> </tr> </tbody> </table> | Item | bit on | bit off | Keypad |  |  | LCD keypad |  |  |
| | Item | bit on | bit off | | | | | | | |
| | Keypad |  |  | | | | | | | |
| LCD keypad |  |  | | | | | | | | |
| Item | bit on | bit off | | | | | | | | |
| Keypad |  |  | | | | | | | | |
| LCD keypad |  |  | | | | | | | | |

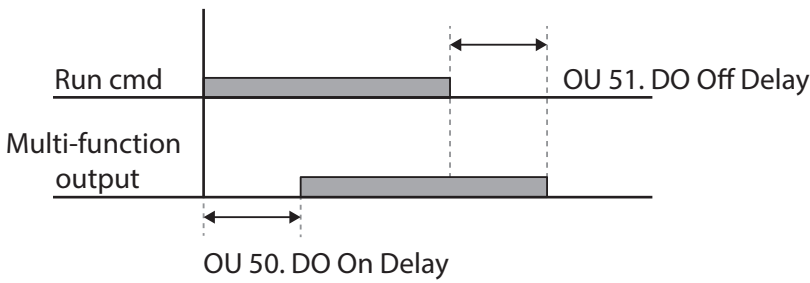

5.35 Keypad Language Settings

Select the language to be displayed on the LCD keypad. Keypad S/W Ver 1.04 and above provides language selections.

| Group | Code | Name | LCD Display | Parameter Setting | | Setting Range | Unit |
|-------|------|------------------------|--------------|-------------------|---------|---------------|------|
| CNF* | 01 | Select keypad language | Language Sel | 0 | English | - | - |
| | | | | 1 | Korean | | |

* Available on LCD keypad only.

5.36 Operation State Monitor

The inverter's operation condition can be monitored using the LCD keypad. If the monitoring option is selected in config (CNF) mode, a maximum of four items can be monitored simultaneously. Monitoring mode displays three different items on the LCD keypad, but only one item can be displayed in the status window at a time.

| Group | Code | Name | LCD Display | Parameter Setting | | Setting Range | Unit |
|-------|------|---------------------------------------|----------------|-------------------|----------------|---------------|------|
| CNF* | 20 | Display item condition display window | Anytime Para | 0 | Frequency | - | - |
| | 21 | Monitor mode display 1 | Monitor Line-1 | 0 | Frequency | - | Hz |
| | 22 | Monitor mode display 2 | Monitor Line-2 | 2 | Output Current | - | A |
| | 23 | Monitor mode display 3 | Monitor Line-3 | 3 | Output Voltage | - | V |
| | 24 | Monitor mode initialize | Mon Mode Init | 0 | No | - | - |

*Available on LCD keypad only.

Operation State Monitor Setting Details

| Code | Description |
|---------------------|---|
| CNF-20 AnyTime Para | Select items to display on the top-right side of the LCD keypad screen. Choose the parameter settings based on the information to be displayed. Codes CNF-20-23 share the same setting options as listed in the table |

| Code | | Description |
|------|----------------|---|
| | | below. |
| | Setting | Function |
| 0 | Frequency | On stop, displays the set frequency. During operation, displays the actual output frequency (Hz). |
| 1 | Speed | On stop, displays the set speed (rpm). During operation, displays the actual operating speed (rpm). |
| 2 | Output Current | Displays output current. |
| 3 | Output Voltage | Displays output voltage. |
| 4 | Output Power | Displays output power. |
| 5 | WHour Counter | Displays inverter power consumption. |
| 6 | DCLink Voltage | Displays DC link voltage within the inverter. |
| 7 | DI Status | Displays input terminal status of the terminal block. Starting from the right, displays P1-P8. |
| 8 | DO Status | Displays output terminal status of the terminal block. Starting from the right, Relay1, Relay2, and Q1. |
| 9 | V1 Monitor[V] | Displays the input voltage value at terminal V1 (V). |
| 10 | V1 Monitor[%] | Displays input voltage terminal V1 value as a percentage. If -10V, 0V, +10V is measured, -100%, 0%, 100% will be displayed. |
| 13 | V2 Monitor[V] | Displays input voltage terminal V2 value (V). |
| 14 | V2 Monitor[%] | Displays input voltage terminal V2 value as a percentage. |
| 15 | I2 Monitor[mA] | Displays input current terminal I2 value (A). |
| 16 | I2 Monitor[%] | Displays input current terminal I2 value as a percentage. |
| 17 | PID Output | Displays output of PID controller. |
| 18 | PID Ref Value | Displays reference value of PID controller. |
| 19 | PID Fdb Value | Displays feedback volume of PID controller. |
| 20 | Torque | If the torque reference command mode (DRV-08) is set to a value other than keypad (0 or 1), the torque reference value is displayed. |
| 21 | Torque Limit | If torque limit setting (Cn.53) is set to a value other than keypad (0 or 1), the torque limit value is displayed. |
| 23 | Spd Limit | If the speed limit setting (Cn.62) on torque control mode is set to a value other than keypad (0 or 1), the speed limit setting is displayed. |

| Code | Description |
|--------------------------|--|
| | 24 Load Speed Displays the speed of a load in the desired scale and unit. Displays the speed of a load that ADV-61 (Load Spd Gain) and ADV-62 (Load Spd Scale) are applied as rpm or mpm set at ADV-63 (Load Spd Unit). |
| CNF-21–23 Monitor Line-x | Select the items to be displayed in monitor mode. Monitor mode is the first displayed mode when the inverter is powered on. A total of three items, from monitor line-1 to monitor line- 3, can be displayed simultaneously. |
| CNF-24 Mon Mode Init | Selecting 1(Yes) initializes CNF-20-23. |

Load Speed Display Setting

| Group | Code | Name | LCD Display | Parameter Setting | Setting Range | Unit |
|---------|--------|----------------------------|----------------|-------------------|---------------|------|
| ADV(M2) | 61(40) | Rotation count speed gain | Load Spd Gain | - 100.0 | 1~6000.0[%] | - |
| | 62(41) | Rotation count speed scale | Load Spd Scale | 0 x 1 | 0~4 | Hz |
| | 63(42) | Rotation count speed unit | Load Spd Unit | 2 rpm | 0~1 | A |

Load Speed Display Setting Detail

| Code | Description |
|---------------------------------|---|
| ADV-61(M2-40) Load Spd Gain | If monitoring item 24 Load Speed is selected and if the motor spindle and the load are connected with belt, the actual number of revolutions can be displayed by calculating the pulley ratio. |
| ADV-62(M2-41) Load Spd Scale | Selects the decimal places that monitoring item 24 Load Speed displays (from x1–x0.0001). |
| ADV-63(M2-42) Load Spd Unit | Selects the unit of monitoring item 24 Load Speed. Selects between RPM (Revolution Per Minute) and MPM (Meter Per Minute) for the unit. For example, if line speed is 300 [mpm] at 800 [rpm], set ADV61 (Load Spd Gain) to "37.5%" to display the line speed. Also, set ADV62 (Load Sped Scale) to "X 0.1" to display the value to the first decimal point. And set ADV63 (Load Spd Unit) to mpm. Now, the monitoring item 24 Load Speed is displayed on the keypad display as 300.0 mpm instead of 800 rpm. |

Note

Inverter power consumption

Values are calculated using voltage and current. Electric power is calculated every second and the results are accumulated. Setting CNF-62 (WH Count Reset) value to 1 (Yes) will reset cumulated electric energy consumption. Power consumption is displayed as shown below:

- Less than 1,000 kW: Units are in kW, displayed in 999.9 kW format.
- 1–99 MW: Units are in MW, displayed in 99.99 MWh format.
- 100–999 MW: Units are in MW, displayed in 999.9 MWh format.
- More than 1,000 MW: Units are in MW, displayed in 9,999 MWh format and can be displayed up to 65,535 MW. (Values exceeding 65,535MW will reset the value to 0, and units will return to kW. It will be displayed in 999.9 kW format).

5.37 Operation Time Monitor

Monitors inverter and fan operation time.

| Group | Code | Name | LCD Display | Parameter Setting | | Setting Range | Unit |
|-------|------|---|----------------|-------------------|----|---------------|------|
| CNF* | 70 | Inverter operation accumulated time | On-time | 0/00/00 00:00 | | - | min |
| | 71 | Inverter operation accumulated time | Run-time | 0/00/00 00:00 | | - | min |
| | 72 | Inverter operation accumulated time initialization | Time Reset | 0 | No | 0–1 | - |
| | 74 | Cooling fan operation accumulated time | Fan time | 0/00/00 00:00 | | - | min |
| | 75 | Cooling fan operation accumulated time initialization | Fan Time Reset | 0 | No | 0–1 | - |

*Available on LCD keypad only.

Operation Time Monitor Setting Details

| Code | Description |
|-----------------------|---|
| CNF-70 On-time | Displays accumulated power supply time. Information is displayed in [YY/MM/DD Hr: Min (0/00/00 00: 00)] format. |
| CNF-71 Run-time | Displays accumulated time of voltage output by operation command input. Information is displayed in [YY/MM/DD Hr: Min (0/00/00 00: 00)] format. |
| CNF-72 Time Reset | Setting 1(Yes) will delete power supply accumulated time (On-time) and operation accumulated time (Run-time) and is displayed as 0/00/00 00:00 format. |
| CNF-74 Fan time | Displays accumulated time of inverter cooling fan operation. Information will be displayed in [YY/MM/DD Hr: Min (0/00/00 00: 00)] format. |
| CNF-75 Fan Time Reset | Setting 1(Yes) will delete cooling fan operation accumulated time(on-time) and operation accumulated time (Run-time) and will display it in 0/00/00 00:00 format. |

6 Learning Protection Features

Protection features provided by the S100 series inverter are categorized into two types: protection from overheating damage to the motor, and protection against the inverter malfunction.

6.1 Motor Protection

6.1.1 Electronic Thermal Motor Overheating Prevention (ETH)

ETH is a protective function that uses the output current of the inverter without a separate temperature sensor, to predict a rise in motor temperature to protect the motor based on its heat characteristics.

| Group | Code | Name | LCD Display | Parameter Setting | | Setting range | Unit |
|-------|------|--|---------------|-------------------|-----------|---------------|------|
| Pr | 40 | Electronic thermal prevention fault trip selection | ETH Trip Sel | 0 | None | 0-2 | - |
| | 41 | Motor cooling fan type | Motor Cooling | 0 | Self-cool | - | - |
| | 42 | Electronic thermal one minute rating | ETH 1min | 150 | | 120-200 | % |
| | 43 | Electronic thermal prevention continuous rating | ETH Cont | 120 | | 50-150 | % |

Electronic Thermal (ETH) Prevention Function Setting Details

| Code | Description | | | | | | | | |
|---------------------|--|------------------------------------|----------|---------------|--|--------------|--|---------|---|
| Pr.40 ETH Trip Sel | ETH can be selected to provide motor thermal protection. The LCD screen displays "E-Thermal." | | | | | | | | |
| | <table border="1"> <thead> <tr> <th>Setting</th> <th>Function</th> </tr> </thead> <tbody> <tr> <td>0 None</td> <td>The ETH function is not activated.</td> </tr> <tr> <td>1 Free-Run</td> <td>The inverter output is blocked. The motor coasts to a halt (free-run).</td> </tr> <tr> <td>2 Dec</td> <td>The inverter decelerates the motor to a stop.</td> </tr> </tbody> </table> | Setting | Function | 0 None | The ETH function is not activated. | 1 Free-Run | The inverter output is blocked. The motor coasts to a halt (free-run). | 2 Dec | The inverter decelerates the motor to a stop. |
| | Setting | Function | | | | | | | |
| | 0 None | The ETH function is not activated. | | | | | | | |
| 1 Free-Run | The inverter output is blocked. The motor coasts to a halt (free-run). | | | | | | | | |
| 2 Dec | The inverter decelerates the motor to a stop. | | | | | | | | |
| Pr.41 Motor Cooling | Select the drive mode of the cooling fan, attached to the motor. | | | | | | | | |
| | <table border="1"> <thead> <tr> <th>Setting</th> <th>Function</th> </tr> </thead> <tbody> <tr> <td>0 Self-cool</td> <td>As the cooling fan is connected to the motor axis, the</td> </tr> </tbody> </table> | Setting | Function | 0 Self-cool | As the cooling fan is connected to the motor axis, the | | | | |
| Setting | Function | | | | | | | | |
| 0 Self-cool | As the cooling fan is connected to the motor axis, the | | | | | | | | |

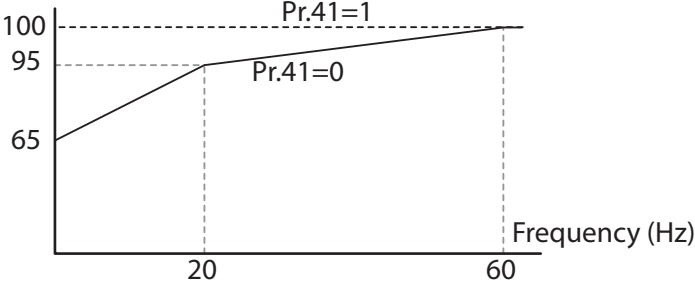
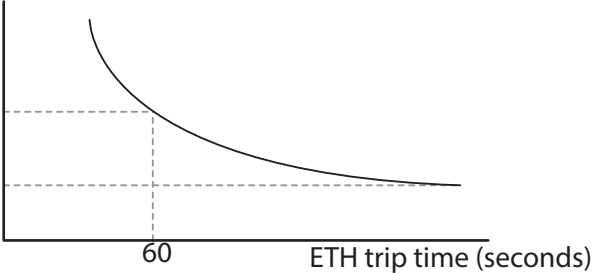
| Code | Description | |
|-----------------|---|--|
| | | cooling effect varies, based on motor speed. Most universal induction motors have this design. |
| | 1 Forced-cool | Additional power is supplied to operate the cooling fan. This provides extended operation at low speeds. Motors designed for inverters typically have this design. |
| Pr.42 ETH 1 min | The amount of input current that can be continuously supplied to the motor for 1 minute, based on the motor-rated current (bA.13). | |
| Pr.43 ETH Cont | Sets the amount of current with the ETH function activated. The range below details the set values that can be used during continuous operation without the protection function. | |
| | <p data-bbox="389 1070 600 1107">Continuous rated current (%)</p>  <p data-bbox="412 542 463 691">100 95 65</p> <p data-bbox="691 542 779 625">Pr.41=1 Pr.41=0</p> <p data-bbox="920 761 1105 788">Frequency (Hz)</p> <p data-bbox="595 799 628 823">20</p> <p data-bbox="897 799 930 823">60</p> | |
| | <p data-bbox="412 1070 509 1097">Current</p>  <p data-bbox="389 1199 454 1226">Pr.42</p> <p data-bbox="389 1271 454 1298">Pr.43</p> <p data-bbox="600 1342 633 1365">60</p> <p data-bbox="769 1342 1053 1369">ETH trip time (seconds)</p> | |

6.1.2 Overload Early Warning and Trip

A warning or fault 'trip' (cutoff) occurs when the motor reaches an overload state, based on the motor's rated current. The amount of current for warnings and trips can be set separately.

| Group | Code | Name | LCD Display | Parameter Setting | | Setting range | Unit |
|-------|------|------------------------------|----------------|-------------------|------------|---------------|------|
| Pr | 04 | Load level setting | Load Duty | 1 | Heavy Duty | - | - |
| | 17 | Overload warning selection | OL Warn Select | 1 | Yes | 0-1 | - |
| | 18 | Overload warning level | OL Warn Level | 150 | | 30-180 | % |
| | 19 | Overload warning time | OL Warn Time | 10.0 | | 0-30 | s |
| | 20 | Motion at overload trip | OL Trip Select | 1 | Free-Run | - | - |
| | 21 | Overload trip level | OL Trip Level | 180 | | 30-200 | % |
| | 22 | Overload trip time | OL Trip Time | 60.0 | | 0-60.0 | s |
| OU | 31 | Multi-function relay 1 item | Relay 1 | 5 | Over Load | - | - |
| | 33 | Multi-function output 1 item | Q1 Define | | | | |

Overload Early Warning and Trip Setting Details

| Coden | Description | | | | | | | | |
|---|---|--|----------|---|--|---|--|---|---|
| Pr.04 Load Duty | Select the load level. | | | | | | | | |
| | <table border="1"> <thead> <tr> <th>Setting</th> <th>Function</th> </tr> </thead> <tbody> <tr> <td>0</td> <td>Normal Duty Used in underloads, like fans and pumps (overload tolerance: 120% of rated underload current for 1 minute).</td> </tr> <tr> <td>1</td> <td>Heavy Duty Used in heavy loads, like hoists, cranes, and parking devices (overload tolerance: 150% of rated heavy load current for 1 minute).</td> </tr> </tbody> </table> | Setting | Function | 0 | Normal Duty Used in underloads, like fans and pumps (overload tolerance: 120% of rated underload current for 1 minute). | 1 | Heavy Duty Used in heavy loads, like hoists, cranes, and parking devices (overload tolerance: 150% of rated heavy load current for 1 minute). | | |
| | Setting | Function | | | | | | | |
| 0 | Normal Duty Used in underloads, like fans and pumps (overload tolerance: 120% of rated underload current for 1 minute). | | | | | | | | |
| 1 | Heavy Duty Used in heavy loads, like hoists, cranes, and parking devices (overload tolerance: 150% of rated heavy load current for 1 minute). | | | | | | | | |
| | | | | | | | | | |
| Pr.17 OL Warn Select | If the overload reaches the warning level, the terminal block multi-function output terminal and relay are used to output a warning signal. If 1 (Yes) is selected, it will operate. If 0 (No) is selected, it will not operate. | | | | | | | | |
| Pr.18 OL Warn Level, Pr.19 OL Warn Time | When the input current to the motor is greater than the overload warning level (OL Warn Level) and continues at that level during the overload warning time (OL Warn Time), the multi-function output (Relay 1, Q1) sends a warning signal. When Over Load is selected at OU.31 and 33, the multi-function output terminal or relay outputs a signal. The the signal output does not block the inverter output. | | | | | | | | |
| Pr.20 OL Trip Select | Select the inverter protective action in the event of an overload fault trip. | | | | | | | | |
| | <table border="1"> <thead> <tr> <th>Setting</th> <th>Function</th> </tr> </thead> <tbody> <tr> <td>0</td> <td>None No protective action is taken.</td> </tr> <tr> <td>1</td> <td>Free-Run In the event of an overload fault, inverter output is blocked and the motor will free-run due to inertia.</td> </tr> <tr> <td>3</td> <td>Dec If a fault trip occurs, the motor decelerates and stops.</td> </tr> </tbody> </table> | Setting | Function | 0 | None No protective action is taken. | 1 | Free-Run In the event of an overload fault, inverter output is blocked and the motor will free-run due to inertia. | 3 | Dec If a fault trip occurs, the motor decelerates and stops. |
| | Setting | Function | | | | | | | |
| | 0 | None No protective action is taken. | | | | | | | |
| 1 | Free-Run In the event of an overload fault, inverter output is blocked and the motor will free-run due to inertia. | | | | | | | | |
| 3 | Dec If a fault trip occurs, the motor decelerates and stops. | | | | | | | | |
| | | | | | | | | | |
| | | | | | | | | | |
| Pr.21 OL Trip Level, Pr.22 OL Trip Time | When the current supplied to the motor is greater than the preset value at the overload trip level (OL Trip Level) and continues to be supplied during the overload trip time (OL Trip Time), the inverter output is either blocked according to the preset mode from Pr. 17 or slows to a stop after deceleration. | | | | | | | | |

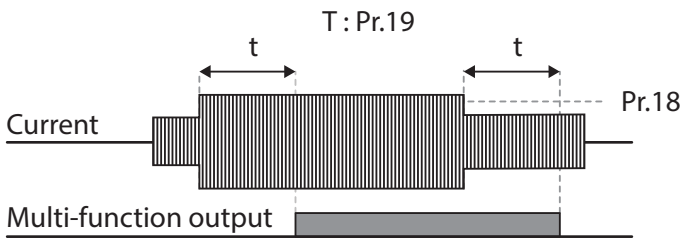

Note

Overload warnings warn of an overload before an overload fault trip occurs. The overload warning signal may not work in an overload fault trip situation, if the overload warn level (OL Warn Level) and the overload warn time (OL Warn Time) are set higher than the overload trip level (OL Trip Level) and overload trip time (OL Trip Time).

6.1.3 Stall Prevention and Flux Braking

The stall prevention function is a protective function that prevents motor stall caused by overloads. If a motor stall occurs due to an overload, the inverter operation frequency is adjusted automatically. When stall is caused by overload, high currents are induced in the motor may cause motor overheat or damage the motor and interrupt operation of the motor-driven devices.

To protect the motor from overload faults, the inverter output frequency is adjusted automatically, based on the size of load.

| Group | Code | Name | LCD Display | Parameter Setting | Setting range | Unit |
|-------|------|-----------------------------------|---------------|-------------------|--------------------------------|------|
| Pr | 50 | Stall prevention and flux braking | Stall Prevent | 0000* | - | bit |
| | 51 | Stall frequency 1 | Stall Freq 1 | 60.00 | Start frequency–Stall Freq 1 | Hz |
| | 52 | Stall level 1 | Stall Level 1 | 180 | 30-250 | % |
| | 53 | Stall frequency 2 | Stall Freq 2 | 60.00 | Stall Freq 1–Stall Freq 3 | Hz |
| | 54 | Stall level 2 | Stall Level 2 | 180 | 30-250 | % |
| | 55 | Stall frequency 3 | Stall Freq 3 | 60.00 | Stall Freq 2–Stall Freq 4 | Hz |
| | 56 | Stall level 3 | Stall Level 3 | 180 | 30-250 | % |
| | 57 | Stall frequency 4 | Stall Freq 4 | 60.00 | Stall Freq 3–Maximum frequency | Hz |
| | 58 | Stall level 4 | Stall Level 4 | 180 | 30-250 | % |

| Group | Code | Name | LCD Display | Parameter Setting | Setting range | Unit |
|-------|------|------------------------------|-------------|-------------------|---------------|------|
| OU | 31 | Multi-function relay 1 item | Relay 1 | 9 | Stall | - |
| | 33 | Multi-function output 1 item | Q1 Define | | | |

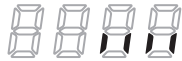

* The value is displayed on the keypad as .

Stall Prevention Function and Flux Braking Setting Details

| Code | Description | | | | | | | | | | | | | | | | | | | | | | | | | | | | |
|---|--|--|------------------|--|--------------------------------------|--|-------|--|--|-------|-------|--|--|---|--------------------------------------|--|--|---|--|--|--|---|--|--|--------------------------------------|---|--|--|--|
| Pr.50 Stall Prevent | Stall prevention can be configured for acceleration, deceleration, or while operating a motor at constant speed. When the top LCD segment is on, the corresponding bit is set. When the bottom LCD segment is on, the corresponding bit is off. | | | | | | | | | | | | | | | | | | | | | | | | | | | | |
| | <table border="1"> <thead> <tr> <th>Item</th> <th>Bit Status (On)</th> <th>Bit Status (Off)</th> </tr> </thead> <tbody> <tr> <td>Keypad</td> <td></td> <td></td> </tr> <tr> <td>LCD keypad</td> <td></td> <td></td> </tr> </tbody> </table> | Item | Bit Status (On) | Bit Status (Off) | Keypad | | | LCD keypad | | | | | | | | | | | | | | | | | | | | | |
| | Item | Bit Status (On) | Bit Status (Off) | | | | | | | | | | | | | | | | | | | | | | | | | | |
| | Keypad | | | | | | | | | | | | | | | | | | | | | | | | | | | | |
| | LCD keypad | | | | | | | | | | | | | | | | | | | | | | | | | | | | |
| | <table border="1"> <thead> <tr> <th colspan="4">Setting</th> <th rowspan="2">Function</th> </tr> <tr> <th>Bit 4</th> <th>Bit 3</th> <th>Bit 2</th> <th>Bit 1</th> </tr> </thead> <tbody> <tr> <td></td> <td></td> <td></td> <td>✓</td> <td>Stall protection during acceleration</td> </tr> <tr> <td></td> <td></td> <td>✓</td> <td></td> <td>Stall protection while operating at a constant speed</td> </tr> <tr> <td></td> <td>✓</td> <td></td> <td></td> <td>Stall protection during deceleration</td> </tr> <tr> <td>✓</td> <td></td> <td></td> <td></td> <td>Flux braking during deceleration</td> </tr> </tbody> </table> | Setting | | | | Function | Bit 4 | Bit 3 | Bit 2 | Bit 1 | | | | ✓ | Stall protection during acceleration | | | ✓ | | Stall protection while operating at a constant speed | | ✓ | | | Stall protection during deceleration | ✓ | | | |
| Setting | | | | Function | | | | | | | | | | | | | | | | | | | | | | | | | |
| Bit 4 | Bit 3 | Bit 2 | Bit 1 | | | | | | | | | | | | | | | | | | | | | | | | | | |
| | | | ✓ | Stall protection during acceleration | | | | | | | | | | | | | | | | | | | | | | | | | |
| | | ✓ | | Stall protection while operating at a constant speed | | | | | | | | | | | | | | | | | | | | | | | | | |
| | ✓ | | | Stall protection during deceleration | | | | | | | | | | | | | | | | | | | | | | | | | |
| ✓ | | | | Flux braking during deceleration | | | | | | | | | | | | | | | | | | | | | | | | | |
| <table border="1"> <thead> <tr> <th colspan="2">Setting</th> <th>Function</th> </tr> </thead> <tbody> <tr> <td>0001</td> <td>Stall protection during acceleration</td> <td>If inverter output current exceeds the preset stall level (Pr. 52, 54, 56, 58) during acceleration, the motor stops accelerating and starts decelerating. If current level stays above the stall level, the motor decelerates to the start frequency (dr.19). If the current level causes deceleration below the preset level while operating the stall protection function, the motor resumes acceleration.</td> </tr> <tr> <td>0010</td> <td>Stall protection while operating at constant speed</td> <td>Similar to stall protection function during acceleration, the output frequency automatically decelerates when the current level exceeds the preset stall level while operating at constant speed. When the load current decelerates below the preset level, it resumes acceleration.</td> </tr> <tr> <td>0100</td> <td>Stall</td> <td>The inverter decelerates and keeps the DC link voltage</td> </tr> </tbody> </table> | Setting | | Function | 0001 | Stall protection during acceleration | If inverter output current exceeds the preset stall level (Pr. 52, 54, 56, 58) during acceleration, the motor stops accelerating and starts decelerating. If current level stays above the stall level, the motor decelerates to the start frequency (dr.19). If the current level causes deceleration below the preset level while operating the stall protection function, the motor resumes acceleration. | 0010 | Stall protection while operating at constant speed | Similar to stall protection function during acceleration, the output frequency automatically decelerates when the current level exceeds the preset stall level while operating at constant speed. When the load current decelerates below the preset level, it resumes acceleration. | 0100 | Stall | The inverter decelerates and keeps the DC link voltage | | | | | | | | | | | | | | | | | |
| Setting | | Function | | | | | | | | | | | | | | | | | | | | | | | | | | | |
| 0001 | Stall protection during acceleration | If inverter output current exceeds the preset stall level (Pr. 52, 54, 56, 58) during acceleration, the motor stops accelerating and starts decelerating. If current level stays above the stall level, the motor decelerates to the start frequency (dr.19). If the current level causes deceleration below the preset level while operating the stall protection function, the motor resumes acceleration. | | | | | | | | | | | | | | | | | | | | | | | | | | | |
| 0010 | Stall protection while operating at constant speed | Similar to stall protection function during acceleration, the output frequency automatically decelerates when the current level exceeds the preset stall level while operating at constant speed. When the load current decelerates below the preset level, it resumes acceleration. | | | | | | | | | | | | | | | | | | | | | | | | | | | |
| 0100 | Stall | The inverter decelerates and keeps the DC link voltage | | | | | | | | | | | | | | | | | | | | | | | | | | | |

| Code | Description | |
|------|---|---|
| | protection during deceleration | below a certain level to prevent an over voltage fault trip during deceleration. As a result, deceleration times can be longer than the set time depending on the load. |
| 1000 | Flux braking during deceleration | When using flux braking, deceleration time may be reduced because regenerative energy is expended at the motor. |
| 1100 | Stall protection and flux braking during deceleration | Stall protection and flux braking operate together during deceleration to achieve the shortest and most stable deceleration performance. |

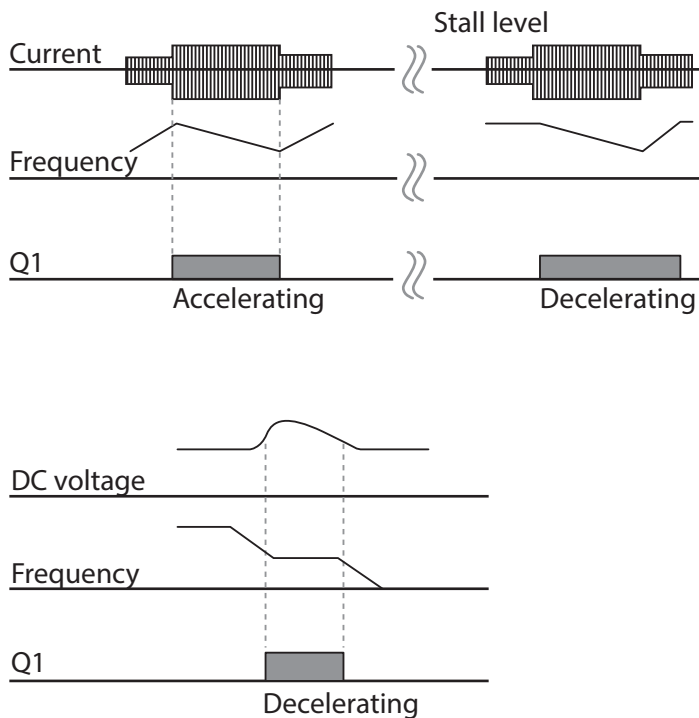

Pr.51 Stall Freq 1-Pr.58 Stall Level 4

Additional stall protection levels can be configured for different frequencies, based on the load type. As shown in the graph below, the stall level can be set above the base frequency. The lower and upper limits are set using numbers that correspond in ascending order. For example, the range for Stall Frequency 2 (Stall Freq 2) becomes the lower limit for Stall Frequency 1 (Stall Freq 1) and the upper limit for Stall Frequency 3 (Stall Freq 3).

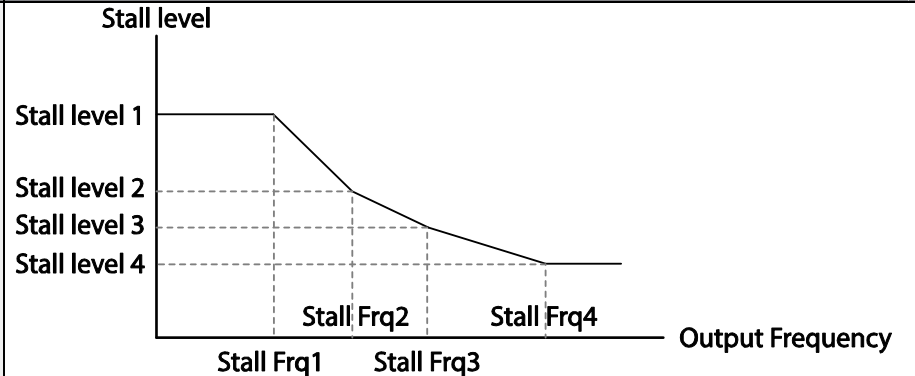
| Code | Description |
|------|--|
| | <p style="text-align: center;">Stall level</p>  |

Note

Stall protection and flux braking operate together only during deceleration. Turn on the third and fourth bits of Pr.50 (Stall Prevention) to achieve the shortest and most stable deceleration performance without triggering an overvoltage fault trip for loads with high inertia and short deceleration times. Do not use this function when frequent deceleration of the load is required, as the motor can overheat and may be damaged easily.

When you operating Brake resistor, the motor may vibrate under the Flux braking operation. In this case, please turn off the Flux braking(Pr.50).

⚠ Caution

- Use caution when decelerating while using stall protection as depending on the load, the deceleration time can take longer than the time set. Acceleration stops when stall protection operates during acceleration. This may make the actual acceleration time longer than the preset acceleration time.
- When the motor is operating, Stall Level 1 applies and determines the operation of stall protection.

6.2 Inverter and Sequence Protection













6.2.1 Open-phase Protection

Open-phase protection is used to prevent overcurrent levels induced at the inverter inputs due to an open-phase within the input power supply. Open-phase output protection is also available. An open-phase at the connection between the motor and the inverter output may cause the motor to stall, due to a lack of torque.

| Group | Code | Name | LCD Display | Parameter Setting | Setting range | Unit |
|-------|------|------------------------------------|----------------|-------------------|---------------|------|
| Pr | 05 | Input/output open-phase protection | Phase Loss Chk | 00* | - | bit |
| | 06 | Open-phase input voltage band | IPOV Band | 40 | 1-100V | V |



*The value is displayed on the keypad as .

Input and Output Open-phase Protection Setting Details

| Code | Description | | | | | | | | | | |
|---|---|---|---|------------------|--------|---|---|------------------------------|---|---|-----------------------------|
| Pr.05 Phase Loss Chk, Pr.06 IPOV Band | When open-phase protection is operating, input and output configurations are displayed differently. When the top LCD segment is On, the corresponding bit is set to On. When the bottom LCD segment is On, the corresponding bit is set to Off. | | | | | | | | | | |
| | <table border="1"> <thead> <tr> <th>Item</th> <th>Bit status (On)</th> <th>Bit status (Off)</th> </tr> </thead> <tbody> <tr> <td>Keypad</td> <td></td> <td></td> </tr> <tr> <td>LCD keypad</td> <td></td> <td></td> </tr> </tbody> </table> | Item | Bit status (On) | Bit status (Off) | Keypad |  |  | LCD keypad |  |  | |
| | Item | Bit status (On) | Bit status (Off) | | | | | | | | |
| | Keypad |  |  | | | | | | | | |
| | LCD keypad |  |  | | | | | | | | |
| <table border="1"> <thead> <tr> <th colspan="2">Setting</th> <th rowspan="2">Function</th> </tr> <tr> <th>Bit 2</th> <th>Bit 1</th> </tr> </thead> <tbody> <tr> <td></td> <td>✓</td> <td>Output open-phase protection</td> </tr> <tr> <td>✓</td> <td></td> <td>Input open-phase protection</td> </tr> </tbody> </table> | Setting | | Function | Bit 2 | Bit 1 | | ✓ | Output open-phase protection | ✓ | | Input open-phase protection |
| Setting | | Function | | | | | | | | | |
| Bit 2 | Bit 1 | | | | | | | | | | |
| | ✓ | Output open-phase protection | | | | | | | | | |
| ✓ | | Input open-phase protection | | | | | | | | | |

6.2.2 External Trip Signal

Set one of the multi-function input terminals to 4 (External Trip) to allow the inverter to stop operation when abnormal operating conditions arise.

| Group | Code | Name | LCD Display | Parameter Setting | Setting range | Unit |
|-------|-------|--|-----------------------|--|---------------|------|
| In | 65-71 | Px terminal setting options | Px Define (Px: P1-P7) | 4 External Trip | - | - |
| | 87 | Multi-function input contact selection | DI NC/NO Sel |   | - | bit |

External Trip Signal Setting Details

| Code | Description | | | | | | | | | | | | | | | | | | | | | | | | |
|--------------------|---|-----|----|----|----|----|----|----|----|----|----|---|---|----------|--|--|--|--|----|----|----|----|----|----|----|
| In.87 DI NC/NO Sel | <p>Selects the type of input contact. If the mark of the switch is at the bottom (0), it operates as an A contact (Normally Open). If the mark is at the top (1), it operates as a B contact (Normally Closed).</p> <p>The corresponding terminals for each bit are as follows:</p> <table border="1"> <thead> <tr> <th>Bit</th> <th>11</th> <th>10</th> <th>9</th> <th>8</th> <th>7</th> <th>6</th> <th>5</th> <th>4</th> <th>3</th> <th>2</th> <th>1</th> </tr> </thead> <tbody> <tr> <td>Terminal</td> <td></td> <td></td> <td></td> <td></td> <td>P7</td> <td>P6</td> <td>P5</td> <td>P4</td> <td>P3</td> <td>P2</td> <td>P1</td> </tr> </tbody> </table> | Bit | 11 | 10 | 9 | 8 | 7 | 6 | 5 | 4 | 3 | 2 | 1 | Terminal | | | | | P7 | P6 | P5 | P4 | P3 | P2 | P1 |
| Bit | 11 | 10 | 9 | 8 | 7 | 6 | 5 | 4 | 3 | 2 | 1 | | | | | | | | | | | | | | |
| Terminal | | | | | P7 | P6 | P5 | P4 | P3 | P2 | P1 | | | | | | | | | | | | | | |

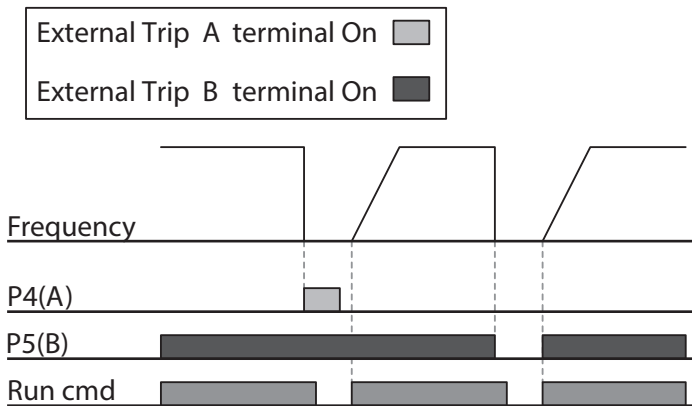

6.2.3 Inverter Overload Protection

When the inverter input current exceeds the rated current, a protective function is activated to prevent damages to the inverter based on inverse proportional characteristics.

| Group | Code | Name | LCD Display | Parameter Setting | Setting range | Unit |
|-------|------|-------------------------|-------------|-------------------|---------------|------|
| OU | 31 | Multi-function relay 1 | Relay 1 | 6 | IOL | - |
| | 33 | Multi-function output 1 | Q1 Define | | | |

Note

A warning signal output can be provided in advance by the multi-function output terminal before the inverter overload protection function (IOLT) operates. When the overcurrent time reaches 60% of the allowed overcurrent (150%, 1 min), a warning signal output is provided (signal output at 150%, 36sec).

6.2.4 Speed Command Loss

When setting operation speed using an analog input at the terminal block, communication options, or the keypad, speed command loss setting can be used to select the inverter operation for situations when the speed command is lost due to the disconnection of signal cables.

| Group | Code | Name | LCD Display | Parameter Setting | | Setting range | Unit |
|-------|------|---|---------------|-------------------|--------------|--------------------------------|------|
| Pr | 12 | Speed command loss operation mode | Lost Cmd Mode | 1 | Free-Run | - | - |
| | 13 | Time to determine speed command loss | Lost Cmd Time | 1.0 | | 0.1-120 | s |
| | 14 | Operation frequency at speed command loss | Lost Preset F | 0.00 | | Start frequency–Max. frequency | Hz |
| | 15 | Analog input loss decision level | AI Lost Level | 0 | Half of x1 | | - |
| OU | 31 | Multi-function Relay 1 | Relay 1 | 13 | Lost Command | - | - |
| | 33 | Multi-function output 1 | Q1 Define | | | | |

Speed Command Loss Setting Details

| Code | Description | | |
|---|---|-------------|--|
| Pr.12 Lost Cmd Mode | In situations when speed commands are lost, the inverter can be configured to operate in a specific mode: | | |
| | Setting | | Function |
| | 0 | None | The speed command immediately becomes the operation frequency without any protection function. |
| | 1 | Free-Run | The inverter blocks output. The motor performs in free-run condition. |
| | 2 | Dec | The motor decelerates and then stops at the time set at Pr.07 (Trip Dec Time). |
| | 3 | Hold Input | The inverter calculates the average input value for 10 seconds before the loss of the speed command and uses it as the speed reference. |
| | 4 | Hold Output | The inverter calculates the average output value for 10 seconds before the loss of the speed command and uses it as the speed reference. |
| Pr.15 AI Lost Level, Pr.13 Lst Cmd Time | Configure the voltage and decision time for speed command loss when using analog input. | | |
| | Setting | | Function |
| | 0 | Half of x1 | Based on the values set at In.08 and In.12, |

| Code | Description | |
|---------------------|--|---|
| | | protective operation starts when the input signal is reduced to half of the initial value of the analog input set using the speed command (Frq code of Operation group) and it continues for the time (speed loss decision time) set at Pr. 13 (Lost Cmd Time). For example, set the speed command to 2 (V1) at the Frq code in the Operation group, and In.06 (V1 Polarity) to 0 (Unipolar). When the voltage input drops to less than half of the value set at In.08 (V1 Volt x 1), the protective function is activated. |
| | 1 | Below x1 The protective operation starts when the signal becomes smaller than the initial value of the analog input set by the speed command and it continues for the speed loss decision time set at Pr.13 (Lost Cmd Time). Codes In.08 and In.12 are used to set the standard values. |
| Pr.14 Lost Preset F | In situations where speed commands are lost, set the operation mode (Pr.12 Lost Cmd Mode) to 5 (Lost Preset). This operates the protection function and sets the frequency so that the operation can continue. | |

Set Pr.15 (AI Lost Level) to 1 (Below x 1), Pr.12 (Lost Cmd Mode) to 2 (Dec), and Pr.13 (Lost Cmd Time) to 5 sec. Then it operates as follows:

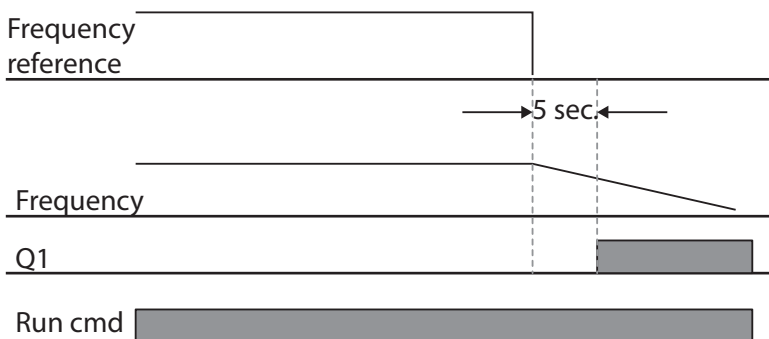

Note

If speed command is lost while using communication options or the integrated RS-485 communication, the protection function operates after the command loss decision time set at Pr.13 (Lost Cmd Time) is passed.

6.2.5 Dynamic Braking (DB) Resistor Configuration

For S100 series, the braking resistor circuit is integrated inside the inverter.

| Group | Code | Name | LCD Display | Parameter Setting | | Setting range | Unit |
|-------|------|--------------------------------|-------------|-------------------|-------------|---------------|------|
| Pr | 66 | Braking resistor configuration | DB Warn %ED | 10 | | 0-30 | % |
| OU | 31 | Multi-function relay 1 item | Relay 1 | 31 | DB Warn %ED | - | - |
| | 33 | Multi-function output 1 item | Q1 Define | | | | |

Dynamic Braking Resistor Setting Details

| Code | Description |
|-------------------|--|
| Pr.66 DB Warn %ED | <p>Set braking resistor configuration (%ED: Duty cycle). Braking resistor configuration sets the rate at which the braking resistor operates for one operation cycle. The maximum time for continuous braking is 15 sec and the braking resistor signal is not output from the inverter after the 15 sec period has expired. An example of braking resistor set up is as follows:</p> $\%ED = \frac{T_{dec}}{T_{acc} + T_{steady} + T_{dec} + T_{stop}} \times 100\%$ <p>[Example 1]</p> $\%ED = \frac{T_{dec}}{T_{dec} + T_{steady1} + T_{acc} + T_{steady2}} \times 100\%$ |

| Code | Description |
|------|---|
| | <p>The diagram shows a frequency profile over time. It starts with a deceleration phase labeled T_{dec}, followed by a constant speed operation phase labeled $T_{steady\ 1}$. Then, it shows an acceleration phase labeled T_{acc}, followed by another constant speed operation phase labeled $T_{steady\ 2}$. The y-axis is labeled 'Frequency'.</p> <p>[Example 2]</p> <ul style="list-style-type: none"> • T_{acc}: Acceleration time to set frequency • T_{steady}: Constant speed operation time at set frequency • T_{dec}: Deceleration time to a frequency lower than constant speed operation or the stop time from constant speed operation frequency • T_{stop}: Stop time until operation resumes |

⚠ Caution

Do not set the braking resistor to exceed the resistor’s power rating. If overloaded, it can overheat and cause a fire. When using a resistor with a heat sensor, the sensor output can be used as an external trip signal for the inverter’s multi-function input.

6.3 Under load Fault Trip and Warning

| Group | Code | Name | LCD Display | Parameter Setting | | Setting range | Unit |
|-------|------|------------------------------|--------------|-------------------|-------------|---------------|------|
| Pr | 04 | Load level selection | Load Duty | 0 | Normal Duty | - | |
| | 25 | Under load warning selection | UL Warn Sel | 1 | Yes | 0-1 | - |
| | 26 | Under load warning time | UL Warn Time | 10.0 | | 0-600 | sec |
| | 27 | Under load trip selection | UL Trip Sel | 1 | Free-Run | - | - |
| | 28 | Under load trip timer | UL Trip Time | 30.0 | | 0-600 | sec |
| | 29 | Under load upper limit level | UL LF Level | 30 | | 10-100 | % |
| | 30 | Under load lower limit level | UL BF Level | 30 | | 10-100 | % |

Under Load Trip and Warning Setting Details

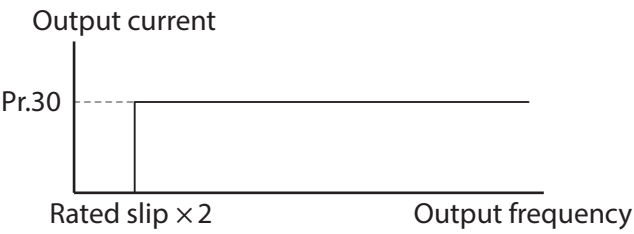
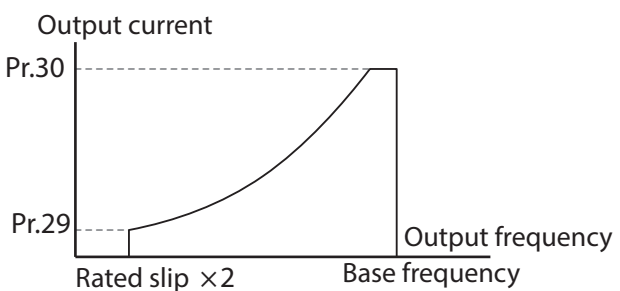
| Code | Description |
|--|--|
| Pr.27 UL Trip Sel | Sets the underload fault trip occurs. If set to 0(None), does not detect the underload fault trip. If set to 1 (Free-Run), the output is blocked in an underload fault trip situation. If set to 2 (Dec), the motor decelerates and stops when an underload trip occurs. |
| Pr.25 UL Warn Sel | Sets the underload warning options. Set to 1(Yes) and set the multi-function output terminals (at OU-31 and 33) to 7 (Underload). The warning signals are output when an underload condition arises. |
| Pr.26 UL Warn Time, Pr.28 UL Trip Time | The protection function operates when the underload level condition explained above is maintained for a set warning time or fault trip time. This function does not operate if energy-saving operation is activated at Ad-50 (E-Save Mode). |
| Pr.29 UL LF Level, Pr.30 UL BF Level | <ul style="list-style-type: none"> Setting Heavy Duty <ul style="list-style-type: none"> - Do not support Pr.29. - At Pr.30, the underload level is decided based on the motor's rated current.  <ul style="list-style-type: none"> Setting Normal Duty <ul style="list-style-type: none"> - At Pr.29, the under load rate is decided based on twice the operation frequency of the motor's rated slip speed (bA.12 Rated Slip). - At Pr.30, the under load rate is decided based on the base frequency set at dr.18 (Base Freq).An upper limit and lower limit is based on the inverter's rated current.  |

6.3.1 Fan Fault Detection

| Group | Code | Name | LCD Display | Parameter Setting | Setting range | Unit |
|-------|------|-----------------------------|---------------|-------------------|---------------|------|
| Pr | 79 | Cooling fan fault selection | FAN Trip Mode | 0 | Trip | |
| OU | 31 | Multi-function relay 1 | Relay 1 | 8 | FAN Warning | - |
| OU | 33 | Multi-function output 1 | Q1 Define | | | |

Fan Fault Detection Setting Details

| Code | Description | | | | | | |
|-------------------------------|---|----------|----------|---|--|---|--|
| Pr.79 FAN Trip Mode | Set the cooling fan fault mode. | | | | | | |
| | <table border="1"> <thead> <tr> <th>Setting</th> <th>Function</th> </tr> </thead> <tbody> <tr> <td>0</td> <td>Trip The inverter output is blocked and the fan trip is displayed when a cooling fan error is detected.</td> </tr> <tr> <td>1</td> <td>Warning When OU.33 (Q1 Define) and OU.31 (Relay1) are set to 8 (FAN Warning), the fan error signal is output and the operation continues.</td> </tr> </tbody> </table> | Setting | Function | 0 | Trip The inverter output is blocked and the fan trip is displayed when a cooling fan error is detected. | 1 | Warning When OU.33 (Q1 Define) and OU.31 (Relay1) are set to 8 (FAN Warning), the fan error signal is output and the operation continues. |
| | Setting | Function | | | | | |
| 0 | Trip The inverter output is blocked and the fan trip is displayed when a cooling fan error is detected. | | | | | | |
| 1 | Warning When OU.33 (Q1 Define) and OU.31 (Relay1) are set to 8 (FAN Warning), the fan error signal is output and the operation continues. | | | | | | |
| OU.33 Q1 Define, OU.31 Relay1 | When the code value is set to 8 (FAN Warning), the fan error signal is output and operation continues. However, when the inverter inside temperature rises above a certain level, output is blocked due to activation of overheat protection. | | | | | | |

6.3.2 Lifetime diagnosis of components

Registering a capacitance reference for inspection

Note

To perform a capacitor diagnosis, a capacitance reference must be measured and registered by setting Pr-61 (CAP Diag) to 1 (Ref Diag) when the inverter is used for the first time. The measured reference value is saved at Pr-63 and is used as the reference for the capacitor life diagnosis.

Refer to the following instructions to measure a reference capacitance.

- 1 Set an appropriate capacitor diagnosis current based on the inverter's rated output at Pr-60 (CAP DiagCurr).
 - The capacitor diagnosis current is a direct current that is applied to the capacitor for inspection, and is defined as a percentage of the rated inverter output. Because the value is defined based on the inverter output, set an appropriate value if the motor has smaller rated current.
- 2 At Pr-62 (CAP Exchange Level), set the capacitor replacement warning level to a value

between 50.0% and 95.0%

- 3 Set Pr-61 (CAP Diag) to "1" (Ref Diag). Then, the direct current set at Pr-60 (CAP DiagCurr) is output.
 - The capacitor diagnosis is only available when the inverter is stopped.
 - If Pr-61 is set to 1 (Ref Diag), the displayed value at Pr-63 reflects 100% of the measured capacitance.
 - If you plan to perform a capacitor diagnosis using Pr-61 (CAP Diag), the initial capacitance must be measured when the inverter is used for the first time. A capacitance measured on a used inverter leads to inaccurate inspection results due to an incorrect reference capacitance value.
- 4 Turn off the input to the inverter.
- 5 Turn on the inverter when a low voltage trip (LVT) occurs.
- 6 View the value displayed at Pr-63 (CAP Diag Level). When Pr-61 is set to "1" (Ref Diag), Pr-63 displays 100% of the capacitance.

[Main Capacitor Diagnosis details]

| Group | Code | Name | LCD Display | Setting value | Setting Range | Unit | |
|-------|--------------------|------------------------------------|---------------|---------------|---------------|-----------|---|
| Pr | 60 | Capacitance Diagnose current Level | CAP. DiagPerc | 0.0 | 10.0-100.0 | % | |
| | 61 | CAP. Diagnosis mode | CAP. Diag | 0 | 0 | None | % |
| | | | | | 1 | Ref Diag | |
| | | | | | 2 | Pre Diag | |
| | | | | | 3 | Init Diag | |
| 62 | CAP Exchange Level | CAP Exchange Level | 0 | 50.0 ~ 95.0 | % | | |
| 63 | CAP Diag Level | CAP Diag Level | 0 | 0.0 ~ 100.0 | % | | |

Inspecting the capacitor life and initializing the capacitance reference

Refer to the following instructions to inspect the capacitor life and initialize the capacitance reference.

Note

To perform a capacitor diagnosis, a capacitance reference must be measured and registered by setting Pr-61 (CAP Diag) to 1 (Ref Diag) when the inverter is used for the first time. The measured reference value is registered at Pr-63, and is used as the reference for the capacitor life diagnosis.

- 1 On an inverter whose run time has reached the cumulated time for capacitor replacement, set Pr-61 (CAP Diag) to 2 (Pre Diag).
- 2 Check the value displayed at Pr-63 (CAP Diag Level). If the value displayed at Pr-63 is smaller than the value set at Pr-62 (CAP. Level 1), a capacitor replacement warning (CAP Exchange) will occur.
- 3 While the capacitor replacement warning continues, confirm that the first bit at Pr-89 (Inverter State) is set.
- 4 Set Pr-62 to 0.0%. The capacitor replacement warning (CAP Exchange) will be released.
- 5 Set Pr-61 to 3 (CAP. Init) and make sure that the value displayed at Pr-63 has changed to 0.0%.

Lifetime diagnosis for fans

Enter the Pr-87(Fan exchange warning level) code (%). After the selected usage (%) is reached (out of 50,000 hours), the fan exchange warning message will appear in the multi-functional output or keypad.

The total fan usage level (%) appears at Pr-86. When exchanging fans, you may initialize the accumulated value to 0 by setting the CNF-75 (Initializing accumulated time for cooling fans) to 1.

| Group | Code | Name | LCD Display | Setting value | | Setting Range | Unit |
|-------|------|---|--------------------|---------------|--------------|---------------|------|
| Pr | 86 | Accumulated percent of fan usage | FAN Time Perc | 0.0 | | 0.0-6553.5 | % |
| | 87 | Fan exchange warning Level | FAN Exchange level | 90.0 | | 0.0-100.0 | % |
| CNF* | 75 | Initialize operation time of cooling fans | FAN Time Rst | 0 | No | - | - |
| | | | | 1 | Yes | | |
| OU | 31 | Multi-function relay 1 | Relay 1 | 38 | FAN Exchange | | - |
| | 32 | Multi-function relay 2 | Relay 2 | | | | |
| | 33 | Multi-function output 1 | Q1 Define | | | | |

*Available on LCD keypad only.

6.3.3 Low Voltage Fault Trip

When inverter input power is lost and the internal DC link voltage drops below a certain voltage level, the inverter stops output and a low voltage trip occurs.

| Group | Code | Name | LCD Display | Parameter Setting | Setting range | Unit |
|-------|------|------------------|-------------|-------------------|---------------|------|
| Pr | 81 | Low voltage trip | LVT Delay | 0.0 | 0-60 | sec |

| Group | Code | Name | LCD Display | Parameter Setting | | Setting range | Unit |
|-------|------|-------------------------|-------------|-------------------|-------------|---------------|------|
| | | decision delay time | | | | | |
| OU | 31 | Multi-function relay 1 | Relay 1 | 11 | Low Voltage | | - |
| | 33 | Multi-function output 1 | Q1 Define | | | | |

Low Voltage Fault Trip Setting Details

| Code | Description |
|-----------------|---|
| Pr.81 LVT Delay | If the code value is set to 11 (Low Voltage), the inverter stops the output first when a low voltage trip condition arises, then a fault trip occurs after the low voltage trip decision time is passed. The warning signal for a low voltage fault trip can be provided using the multi-function output or a relay. However, the low voltage trip delay time (LVT Delay time) does not apply to warning signals. |

6.3.4 Output Block by Multi-Function Terminal

When the multi-function input terminal is set as the output block signal terminal and the signal is input to the terminal, then the operation stops.

| Group | Code | Name | LCD Display | Parameter Setting | | Setting range | Unit |
|-------|-------|-----------------------------|----------------------|-------------------|----|---------------|------|
| In | 65-71 | Px terminal setting options | Px Define(Px: P1-P7) | 5 | BX | - | - |

Output Block by Multi-Function Terminal Setting Details

| Code | Description |
|--------------------|---|
| In.65-71 Px Define | When the operation of the multi-function input terminal is set to 5 (BX) and is turned on during operation, the inverter blocks the output and 'BX' is displayed on the keypad display. While 'BX' is displayed on the keypad screen, the inverter's operation information including the operation frequency and current at the time of BX signal can be monitored. The inverter resumes operation when the BX terminal turns off and operation command is input. |

6.3.5 Trip Status Reset

Restart the inverter using the keypad or analog input terminal, to reset the trip status.

| Group | Code | Name | LCD Display | Parameter Setting | | Setting range | Unit |
|-------|-------|-----------------------------|----------------------|-------------------|-----|---------------|------|
| In | 65-71 | Px terminal setting options | Px Define(Px: P1-P7) | 3 | RST | - | - |

Trip Status Reset Setting Details

| Code | Description |
|--------------------|--|
| In.65-71 Px Define | Press [Stop/Reset] key on the keypad or use the multi-function input terminal to restart the inverter. Set the multi-function input terminal to 3 (RST) and turn on the terminal to reset the trip status. |

6.3.6 Inverter Diagnosis State

Check the diagnosis of components or devices for inverter to check if they need to be replaced.

| Group | Code | Name | LCD Display | Parameter Setting | Setting Range | Unit | |
|-------|------|------------------------------|----------------|---|---------------|-------------|-----|
| PRT | 89 | CAP, FAN replacement warning | Inverter State |  | Bit | 00-10 | Bit |
| | | | | | 00 | - | |
| | | | | | 01 | CAP Warning | |
| | | | | | 10 | FAN Warning | |

6.3.7 Operation Mode on Option Card Trip

Option card trips may occur when an option card is used with the inverter. Set the operation mode for the inverter when a communication error occurs between the option card and the inverter body, or when the option card is detached during operation.

| Group | Code | Name | LCD Display | Parameter Setting | Setting range | Unit | |
|-------|------|------------------------------------|---------------|-------------------|---------------|------|---|
| Pr | 80 | Operation mode on option card trip | Opt Trip Mode | 0 | None | 0-3 | - |
| | | | | 1 | Free-Run | | |
| | | | | 2 | Dec | | |

Operation Mode on Option Trip Setting Details

| Code | Description | |
|---------------------|-------------|---|
| Pr.80 Opt Trip Mode | Setting | Function |
| | 0 | None No operation |
| | 1 | Free-Run The inverter output is blocked and fault trip information is shown on the keypad. |
| | 2 | Dec The motor decelerates to the value set at Pr.07 (Trip Dec Time). |

6.3.8 No Motor Trip

If an operation command is run when the motor is disconnected from the inverter output terminal, a 'no motor trip' occurs and a protective operation is performed by the system.

| Group | Code | Name | LCD Display | Parameter Setting | Setting range | Unit |
|-------|------|-----------------------------|----------------|-------------------|---------------|------|
| Pr | 31 | Operation on no motor trip | No Motor Trip | 0 None | - | - |
| | 32 | No motor trip current level | No Motor Level | 5 | 1-100 | % |
| | 33 | No motor detection time | No Motor Time | 3.0 | 0.1-10 | s |

No Motor Trip Setting Details

| Code | Description |
|---|--|
| Pr.32 No Motor Level, Pr.33 No Motor Time | If the output current value [based on the rated current (bA.13)] is lower than the value set at Pr.32 (No Motor Level), and if this continues for the time set at Pr.33 (No Motor Time), a 'no motor trip' occurs. |

⚠ Caution

If bA.07 (V/F Pattern) is set to 1 (Square), set Pr.32 (No Motor Level) to a value lower than the factory default. Otherwise, 'no motor trip' due to a lack of output current will result when the 'no motor trip' operation is set.

6.3.9 Low voltage trip 2

If you set the Pr-82(LV2 Selection) code to Yes (1), the trip notification is displayed when a low voltage trip occurs. In this case, even if the voltage of the DC Link condenser is higher than the trip level, the LV2 trip will not be retrieved. To retrieve the trip, reset the inverter. The trip history will not be saved.

| Group | Code | Name | LCD Display | Parameter Setting | Setting Range | Unit |
|-------|------|---------------|-------------|-------------------|---------------|------|
| Pr | 82 | LV2 Selection | LV2 Enable | Yes(1) | 0/1 | - |

6.4 Fault/Warning List

The following list shows the types of faults and warnings that can occur while using the S100 inverter. Please refer to [6 Learning Protection Features](#) on page 197 for details about faults and warnings.

| Category | | LCD Display | Details |
|-----------------|------------------|---------------------------------|---|
| Major fault | Latch type | Over Current1 | Over current trip |
| | | Over Voltage | Over voltage trip |
| | | External Trip | Trip due to an external signal |
| | | NTC Open | Temperature sensor fault trip |
| | | Over Current2 | ARM short current fault trip |
| | | Option Trip-x* | Option fault trip* |
| | | Over Heat | Over heat fault trip |
| | | Out Phase Open | Output open-phase fault trip |
| | | In Phase Open | Input open-phase fault trip |
| | | Inverter OLT | Inverter overload fault trip |
| | | Ground Trip | Ground fault trip |
| | | Fan Trip | Fan fault trip |
| | | E-Thermal | Motor overheat fault trip |
| | | Pre-PID Fail | Pre-PID operation failure |
| | | IO Board Trip | IO Board connection fault trip |
| | | Ext-Brake | External brake fault trip |
| | | No Motor Trip | No motor fault trip |
| | | Low Voltage 2 | Low voltage fault trip during operation |
| | ParaWrite Trip** | Write parameter fault trip | |
| | Level type | Low Voltage | Low voltage fault trip |
| BX | | Emergency stop fault trip | |
| Lost Command | | Command loss trip | |
| Safety A(B) Err | | Safety A(B) contact trip | |
| Hardware damage | EEP Err | External memory error | |
| | ADC Off Set | Analog input error | |
| | Watch Dog-1 | CPU Watch Dog fault trip | |
| | Watch Dog-2 | | |
| Minor fault | Over Load | Motor overload fault trip | |
| | Under Load | Motor underload fault trip | |
| Warning | Lost Command | Command loss fault trip warning | |
| | Over Load | Overload warning | |
| | Under Load | Under load warning | |

| Category | LCD Display | Details |
|----------|---------------|---------------------------------------|
| | Inverter OLT | Inverter overload warning |
| | Fan Warning | Fan operation warning |
| | DB Warn %ED | Braking resistor braking rate warning |
| | Retry Tr Tune | Rotor time constant tuning error |
| | CAP Exchange | Capacitor replacement warning |
| | FAN Exchange | Fan replacement warning |

* Applies only when an option board is used.

** Displayed on an LCD keypad only.

7 RS-485 Communication Features

This section in the user manual explains how to control the inverter with a PLC or a computer over a long distance using the RS-485 communication features. To use the RS-485 communication features, connect the communication cables and set the communication parameters on the inverter. Refer to the communication protocols and parameters to configure and use the RS-485 communication features.

7.1 Communication Standards

Following the RS-485 communication standards, S100 products exchange data with a PLC and computer. The RS-485 communication standards support the Multi-drop Link System and offer an interface that is strongly resistant to noise. Please refer to the following table for details about the communication standards.

| Item | Standard |
|--|---|
| Communication method/ Transmission type | RS-485/Bus type, Multi-drop Link System |
| Inverter type name | S100 |
| Number of connected inverters/ Transmission distance | Maximum of 16 inverters / Maximum 1,200m (recommended distance: within 700m) |
| Recommended cable size | 0.75mm ² , (18AWG), Shielded Type Twisted-Pair (STP) Wire |
| Installation type | Dedicated terminals (S+/S-/SG) on the control terminal block |
| Power supply | Supplied by the inverter - insulated power source from the inverter's internal circuit |
| Communication speed | 1,200/2,400/9,600/19,200/38,400/57,600/115,200 bps |
| Control procedure | Asynchronous communications system |
| Communication system | Half duplex system |
| Character system | Modbus-RTU: Binary / LS Bus: ASCII |
| Stop bit length | 1-bit/2-bit |
| Frame error check | 2 bytes |
| Parity check | None/Even/Odd |

7.2 Communication System Configuration

In an RS-485 communication system, the PLC or computer is the master device and the inverter is the slave device. When using a computer as the master, the RS-232 converter must be integrated

with the computer, so that it can communicate with the inverter through the RS-232/RS-485 converter. Specifications and performance of converters may vary depending on the manufacturer, but the basic functions are identical. Please refer to the converter manufacturer's user manual for details about features and specifications.

Connect the wires and configure the communication parameters on the inverter by referring to the following illustration of the communication system configuration.

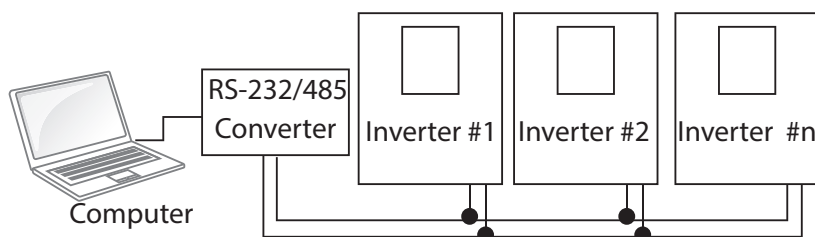

7.2.1 Communication Line Connection

Make sure that the inverter is turned off completely, and then connect the RS-485 communication line to the S+/S-/SG terminals of the terminal block. The maximum number of inverters you can connect is 16. For communication lines, use shielded twisted pair (STP) cables.

The maximum length of the communication line is 1,200 meters, but it is recommended to use no more than 700 meters of communication line to ensure stable communication. Please use a repeater to enhance the communication speed when using a communication line longer than 1,200 meters or when using a large number of devices. A repeater is effective when smooth communication is not available due to noise interference.

⚠ Caution

When wiring the communication line, make sure that the SG terminals on the PLC and inverter are connected. SG terminals prevent communication errors due to electronic noise interference.

7.2.2 Setting Communication Parameters

Before proceeding with setting communication configurations, make sure that the communication lines are connected properly. Turn on the inverter and set the communication parameters.

| Group | Code | Name | LCD Display | Parameter Setting | Setting range | Unit |
|-------|------|--------------------------------------|--------------|-------------------|---------------|------|
| CM | 01 | Built-in communication inverter ID | Int485 St ID | 1 | 1-250 | - |
| | 02 | Built-in communication protocol | Int485 Proto | 0 ModBus RTU | 0, 2 | - |
| | 03 | Built-in communication speed | Int485 BaudR | 3 9600 bps | 0-7 | - |
| | 04 | Built-in communication frame setting | Int485 Mode | 0 D8/PN/S1 | 0-3 | - |
| | 05 | Transmission delay after reception | Resp Delay | 5 | 0-1000 | ms |

Communication Parameters Setting Details

| Code | Description | | | | | | | | | | | | | | | | | | |
|---|--|------------|------------|---|--------------------------------|--|--|---------------------------------------|------------|--------------------------------------|-----------|---|------------|---|------------|---|---------|---|----------|
| CM.01 Int485 St ID | Set the inverter station ID between 1 and 250. | | | | | | | | | | | | | | | | | | |
| CM.02 Int485 Proto | Select one of the two built-in protocols: Modbus-RTU or LS INV 485. | | | | | | | | | | | | | | | | | | |
| | <table border="1"> <thead> <tr> <th>Setting</th> <th>Function</th> </tr> </thead> <tbody> <tr> <td>0 Modbus-RTU</td> <td>Modbus-RTU compatible protocol</td> </tr> <tr> <td>2 LS INV 485</td> <td>Dedicated protocol for the LS inverter</td> </tr> </tbody> </table> | Setting | Function | 0 Modbus-RTU | Modbus-RTU compatible protocol | 2 LS INV 485 | Dedicated protocol for the LS inverter | | | | | | | | | | | | |
| | Setting | Function | | | | | | | | | | | | | | | | | |
| 0 Modbus-RTU | Modbus-RTU compatible protocol | | | | | | | | | | | | | | | | | | |
| 2 LS INV 485 | Dedicated protocol for the LS inverter | | | | | | | | | | | | | | | | | | |
| CM.03 Int485 BaudR | Set a communication setting speed up to 115,200 bps. | | | | | | | | | | | | | | | | | | |
| CM.04 Int485 Mode | <table border="1"> <thead> <tr> <th>Setting</th> <th>Function</th> </tr> </thead> <tbody> <tr> <td>0</td> <td>1,200 bps</td> </tr> <tr> <td>1</td> <td>2,400 bps</td> </tr> <tr> <td>2</td> <td>4,800 bps</td> </tr> <tr> <td>3</td> <td>9,600 bps</td> </tr> <tr> <td>4</td> <td>19,200 bps</td> </tr> <tr> <td>5</td> <td>38,400 bps</td> </tr> <tr> <td>6</td> <td>56K bps</td> </tr> <tr> <td>7</td> <td>115 Kbps</td> </tr> </tbody> </table> | Setting | Function | 0 | 1,200 bps | 1 | 2,400 bps | 2 | 4,800 bps | 3 | 9,600 bps | 4 | 19,200 bps | 5 | 38,400 bps | 6 | 56K bps | 7 | 115 Kbps |
| | Setting | Function | | | | | | | | | | | | | | | | | |
| | 0 | 1,200 bps | | | | | | | | | | | | | | | | | |
| | 1 | 2,400 bps | | | | | | | | | | | | | | | | | |
| | 2 | 4,800 bps | | | | | | | | | | | | | | | | | |
| | 3 | 9,600 bps | | | | | | | | | | | | | | | | | |
| | 4 | 19,200 bps | | | | | | | | | | | | | | | | | |
| | 5 | 38,400 bps | | | | | | | | | | | | | | | | | |
| 6 | 56K bps | | | | | | | | | | | | | | | | | | |
| 7 | 115 Kbps | | | | | | | | | | | | | | | | | | |
| Set a communication configuration. Set the data length, parity check method, and the number of stop bits. | | | | | | | | | | | | | | | | | | | |
| <table border="1"> <thead> <tr> <th>Setting</th> <th>Function</th> </tr> </thead> <tbody> <tr> <td>0 D8/PN/S1</td> <td>8-bit data / no parity check / 1 stop bit</td> </tr> <tr> <td>1 D8/PN/S2</td> <td>8-bit data / no parity check / 2 stop bits</td> </tr> <tr> <td>2 D8/PE/S1</td> <td>8-bit data / even parity / 1 stop bit</td> </tr> <tr> <td>3 D8/PO/S1</td> <td>8-bit data / odd parity / 1 stop bit</td> </tr> </tbody> </table> | Setting | Function | 0 D8/PN/S1 | 8-bit data / no parity check / 1 stop bit | 1 D8/PN/S2 | 8-bit data / no parity check / 2 stop bits | 2 D8/PE/S1 | 8-bit data / even parity / 1 stop bit | 3 D8/PO/S1 | 8-bit data / odd parity / 1 stop bit | | | | | | | | | |
| Setting | Function | | | | | | | | | | | | | | | | | | |
| 0 D8/PN/S1 | 8-bit data / no parity check / 1 stop bit | | | | | | | | | | | | | | | | | | |
| 1 D8/PN/S2 | 8-bit data / no parity check / 2 stop bits | | | | | | | | | | | | | | | | | | |
| 2 D8/PE/S1 | 8-bit data / even parity / 1 stop bit | | | | | | | | | | | | | | | | | | |
| 3 D8/PO/S1 | 8-bit data / odd parity / 1 stop bit | | | | | | | | | | | | | | | | | | |
| CM.05 Resp Delay | Set the response time for the slave (inverter) to react to the request from the | | | | | | | | | | | | | | | | | | |

| Code | Description |
|------|---|
| | <p>master. Response time is used in a system where the slave device response is too fast for the master device to process. Set this code to an appropriate value for smooth master-slave communication.</p> |

7.2.3 Setting Operation Command and Frequency

To select the built-in RS485 communication as the source of command, set the Frq code to 6 (Int485) on the keypad (basic keypad with 7-segment display). On an LCD keypad, set the DRV code to 3 (Int485). Then, set common area parameters for the operation command and frequency via communication.

| Group | Code | Name | LCD Display | Parameter Setting | | Setting range | Unit |
|-------|------|---|---------------|-------------------|--------------|-----------------------------------|------|
| Pr | 12 | Speed command loss operation mode | Lost Cmd Mode | 1 | Free-Run | 0-5 | - |
| | 13 | Time to determine speed command loss | Lost Cmd Time | 1.0 | | 0.1-120 | s |
| | 14 | Operation frequency at speed command loss | Lost Preset F | 0.00 | | Start frequency–Maximum frequency | Hz |
| OU | 31 | Multi-function relay 1 | Relay 1 | 13 | Lost Command | 0-35 | - |
| | 33 | Multi-function output 1 | Q1 Define | | | | |

| Group | Code | Name | LCD Display | Parameter Setting | | Setting range | Unit |
|-----------|------|--------------------------|--------------|-------------------|---------|---------------|------|
| Operation | DRV | Command source | Cmd Source* | 3 | Int 485 | 0-5 | - |
| | Frq | Frequency setting method | Freq Ref Src | 6 | Int 485 | 0-12 | - |

* Displayed in DRV-06 on an LCD keypad.

7.2.4 Command Loss Protective Operation

Configure the command loss decision standards and protective operations run when a communication problem lasts for a specified period of time.

Command Loss Protective Operation Setting Details

| Code | Description | |
|---|--|---|
| Pr.12 Lost Cmd Mode, Pr.13 Lost Cmd Time | Select the operation to run when a communication error has occurred and lasted exceeding the time set at Pr. 13. | |
| | Setting | Function |
| | 0 | None The speed command immediately becomes the operation frequency without any protection function. |
| | 1 | Free-Run The inverter blocks output. The motor performs in free-run condition. |
| | 2 | Dec The motor decelerates and then stops at the time set at Pr.07 (Trip Dec Time). |
| | 3 | Hold Input The inverter calculates the average input value for 10 seconds before the loss of the speed command and uses it as the speed reference. |
| | 4 | Hold Output The inverter calculates the average output value for 10 seconds before the loss of the speed command and uses it as the speed reference. |
| | 5 | Lost Preset The inverter operates at the frequency set at Pr. 14 (Lost Preset F). |

7.2.5 Setting Virtual Multi-Function Input

Multi-function input can be controlled using a communication address (0h0385). Set codes CM.70–77 to the functions to operate, and then set the BIT relevant to the function to 1 at 0h0322 to operate it. Virtual multi-function operates independently from In.65-71 analog multi-function inputs and cannot be set redundantly. Virtual multi-function input can be monitored using CM.86 (Virt DI Status). Before you configure the virtual multi-function inputs, set the DRV code according to the command source.

| Group | Code | Name | LCD Display | Parameter Setting | | Setting range | Unit |
|-------|-------|---|-----------------------|-------------------|------|---------------|------|
| CM | 70-77 | Communication multi-function input x | Virtual DI x (x: 1-8) | 0 | None | 0-49 | - |
| | 86 | Communication multi-function input monitoring | Virt DI Status | - | - | - | - |

Example: When sending an Fx command by controlling virtual multi-function input in the common area via Int485, set CM.70 to FX and set address 0h0322 to 0h0001.

Note

The following are values and functions that are applied to address 0h0322:

| Setting | Function |
|---------|------------------------|
| 0h0001 | Forward operation (Fx) |
| 0h0003 | Reverse operation (Rx) |
| 0h0000 | Stop |

7.2.6 Saving Parameters Defined by Communication

If you turn off the inverter after setting the common area parameters or keypad parameters via communication and operate the inverter, the changes are lost and the values changed via communication revert to the previous setting values when you turn on the inverter.

Set CNF-48 to 1 (Yes) to allow all the changes over communication to be saved, so that the inverter retains all the existing values even after the power has been turned off.

Setting address 0h03E0 to 0 and then setting it again to 1 via communication allows the existing parameter settings to be saved. However, setting address 0h03E0 to 1 and then setting it to 0 does not carry out the same function. Parameters defined by communication can only be saved using an LCD keypad.

| Group | Code | Name | LCD Display | Parameter Setting | | Setting range | Unit |
|-------|------|-----------------|----------------|-------------------|-----|---------------|------|
| CNF* | 48 | Save parameters | Parameter Save | 0 | No | 0-1 | - |
| | | | | 1 | Yes | | |

*Available on an LCD keypad only.

7.2.7 Total Memory Map for Communication

| Communication Area | Memory Map | Details |
|--------------------------------------|---------------|---|
| Communication common compatible area | 0h0000-0h00FF | iS5, iP5A, iV5, iG5A compatible area |
| Parameter registration type area | 0h0100-0h01FF | Areas registered at CM.31–38 and CM.51–58 |
| | 0h0200-0h023F | Area registered for User Group |
| | 0h0240-0h027F | Area registered for Macro Group |
| | 0h0280-0h02FF | Reserved |
| S100 communication common area | 0h0300-0h037F | Inverter monitoring area |
| | 0h0380-0h03DF | Inverter control area |
| | 0h03E0-0h03FF | Inverter memory control area |
| | 0h0400-0h0FFF | Reserved |
| | 0h1100 | dr Group |
| | 0h1200 | bA Group |
| | 0h1300 | Ad Group |
| | 0h1400 | Cn Group |
| | 0h1500 | In Group |
| | 0h1600 | OU Group |
| | 0h1700 | CM Group |
| | 0h1800 | AP Group |
| | 0h1B00 | Pr Group |
| | 0h1C00 | M2 Group |

7.2.8 Parameter Group for Data Transmission

By defining a parameter group for data transmission, the communication addresses registered in the communication function group (CM) can be used in communication. Parameter group for data transmission may be defined to transmit multiple parameters at once, into the communication frame.

| Group | Code | Name | LCD Display | Parameter Setting | | Setting range | Unit |
|-------|-------|--------------------------------|----------------|-------------------|---|---------------|------|
| CM | 31-38 | Output communication address x | Para Status-x | - | - | 0000-FFFF | Hex |
| | 51-58 | Input communication address x | Para Control-x | - | - | 0000-FFFF | Hex |

Currently Registered CM Group Parameter

| Address | Parameter | Assigned content by bit |
|---------------|---|---|
| 0h0100-0h0107 | Status Parameter-1- Status Parameter-8 | Parameter communication code value registered at CM.31-38 (Read-only) |
| 0h0110-0h0117 | Control Parameter-1- Control Parameter-8 | Parameter communication code value registered at CM.51-58 (Read/Write access) |

Note

When registering control parameters, register the operation speed (0h0005, 0h0380, 0h0381) and operation command (0h0006, 0h0382) parameters at the end of a parameter control frame. For example, when the parameter control frame has 5 parameter control items (Para Control - x), register the operation speed at Para Control-4 and the operation command to Para Control-5.

7.3 Communication Protocol

The built-in RS-485 communication supports LS INV 485 and Modbus-RTU protocols.

7.3.1 LS INV 485 Protocol

The slave device (inverter) responds to read and write requests from the master device (PLC or PC).

Request

| ENQ | Station ID | CMD | Data | SUM | EOT |
|--------|------------|--------|---------|---------|--------|
| 1 byte | 2 bytes | 1 byte | n bytes | 2 bytes | 1 byte |

Normal Response

| ACK | Station ID | CMD | Data | SUM | EOT |
|--------|------------|--------|-------------|---------|--------|
| 1 byte | 2 bytes | 1 byte | n x 4 bytes | 2 bytes | 1 byte |

Error Response

| NAK | Station ID | CMD | Error code | SUM | EOT |
|--------|------------|--------|------------|---------|--------|
| 1 byte | 2 bytes | 1 byte | 2 bytes | 2 bytes | 1 byte |

- A request starts with ENQ and ends with EOT.

- A normal response starts with ACK and ends with EOT.
- An error response starts with NAK and ends with EOT.
- A station ID indicates the inverter number and is displayed as a two-byte ASCII-HEX string that uses characters 0-9 and A-F.
- CMD: Uses uppercase characters (returns an IF error if lowercase characters are encountered)—please refer to the following table.

| Character | ASCII-HEX | Command |
|-----------|-----------|------------------------------|
| 'R' | 52h | Read |
| 'W' | 57h | Write |
| 'X' | 58h | Request monitor registration |
| 'Y' | 59h | Perform monitor registration |

- Data: ASCII-HEX (for example, when the data value is 3000: 3000 → '0'B'B'8'h → 30h 42h 42h 38h)
- Error code: ASCII-HEX (refer to [7.3.1.4 Error Code](#) on page 230)
- Transmission/reception buffer size: Transmission=39 bytes, Reception=44 bytes
- Monitor registration buffer: 8 Words
- SUM: Checks communication errors via sum.
SUM=a total of the lower 8 bits values for station ID, command and data (Station ID+CMD+Data) in ASCII-HEX.
For example, a command to read 1 address from address 3000:
SUM='0'+ '1'+ 'R'+ '3'+ '0'+ '0'+ '0'+ '1' = 30h+31h+52h+33h+30h+30h+30h+31h = **1A7h** (the control value is not included: ENQ, ACK, NAK, etc.).

| ENQ | Station ID | CMD | Address | Number of Addresses | SUM | EOT |
|--------|------------|--------|---------|---------------------|---------|--------|
| 05h | '01' | 'R' | '3000' | '1' | 'A7' | 04h |
| 1 byte | 2 bytes | 1 byte | 4 bytes | 1 byte | 2 bytes | 1 byte |

Note

Broadcasting

Broadcasting sends commands to all inverters connected to the network simultaneously. When commands are sent from station ID 255, each inverter acts on the command regardless of the station ID. However no response is issued for commands transmitted by broadcasting.

7.3.1.1 Detailed Read Protocol

Read Request: Reads successive n words from address XXXX.

| ENQ | Station ID | CMD | Address | Number of Addresses | SUM | EOT |
|--------|------------|--------|---------|---------------------|---------|--------|
| 05h | '01'-FA' | 'R' | 'XXXX' | '1'-8'= n | 'XX' | 04h |
| 1 byte | 2 bytes | 1 byte | 4 bytes | 1 byte | 2 bytes | 1 byte |

Total bytes=12. Characters are displayed inside single quotation marks(').

Read Normal Response

| ACK | Station ID | CMD | Data | SUM | EOT |
|--------|------------|--------|-------------|---------|--------|
| 06h | '01'-FA' | 'R' | 'XXXX' | 'XX' | 04h |
| 1 byte | 2 bytes | 1 byte | n x 4 bytes | 2 bytes | 1 byte |

Total bytes= (7 x n x 4): a maximum of 39

Read Error Response

| NAK | Station ID | CMD | Error code | SUM | EOT |
|--------|------------|--------|------------|---------|--------|
| 15h | '01'-FA' | 'R' | '**' | 'XX' | 04h |
| 1 byte | 2 bytes | 1 byte | 2 bytes | 2 bytes | 1 byte |

Total bytes=9

7.3.1.2 Detailed Write Protocol

Write Request: Writes successive n words to address XXXX.

| ENQ | Station ID | CMD | Address | Number of Addresses | Data | SUM | EOT |
|--------|------------|--------|---------|---------------------|-------------|---------|--------|
| 05h | '01'-FA' | 'W' | 'XXXX' | '1'-8'= n | 'XXXX...' | 'XX' | 04h |
| 1 byte | 2 bytes | 1 byte | 4 bytes | 1 byte | n x 4 bytes | 2 bytes | 1 byte |

Total bytes= (12 + n x 4): a maximum of 44

Write Normal Response

| ACK | Station ID | CMD | Data | SUM | EOT |
|--------|------------|--------|-------------|---------|--------|
| 06h | '01'-FA' | 'W' | 'XXXX...' | 'XX' | 04h |
| 1 byte | 2 bytes | 1 byte | n x 4 bytes | 2 bytes | 1 byte |

Total bytes= (7 + n x 4): a maximum of 39

Write Error Response

| NAK | Station ID | CMD | Error Code | SUM | EOT |
|--------|------------|--------|------------|---------|--------|
| 15h | '01'-FA' | 'W' | '**' | 'XX' | 04h |
| 1 byte | 2 bytes | 1 byte | 2 bytes | 2 bytes | 1 byte |

Total bytes=9

7.3.1.3 Monitor Registration Detailed Protocol

Monitor registration request is made to designate the type of data that requires continuous monitoring and periodic updating.

Monitor Registration Request: Registration requests for n addresses (where n refers to the number of addresses. The addresses do not have to be contiguous.)

| ENQ | Station ID | CMD | Number of Addresses | Address | SUM | EOT |
|--------|------------|--------|---------------------|-------------|---------|--------|
| 05h | '01'-FA' | 'X' | '1'-8'=n | 'XXXX...' | 'XX' | 04h |
| 1 byte | 2 bytes | 1 byte | 1 byte | n x 4 bytes | 2 bytes | 1 byte |

Total bytes= (8 + $n \times 4$): a maximum of 40

Monitor Registration Normal Response

| ACK | Station ID | CMD | SUM | EOT |
|--------|------------|--------|---------|--------|
| 06h | '01'-FA' | 'X' | 'XX' | 04h |
| 1 byte | 2 bytes | 1 byte | 2 bytes | 1 byte |

Total bytes=7

Monitor Registration Error Response

| NAK | Station ID | CMD | Error Code | SUM | EOT |
|--------|------------|--------|------------|---------|--------|
| 15h | '01'-FA' | 'X' | '**' | 'XX' | 04h |
| 1 byte | 2 bytes | 1 byte | 2 bytes | 2 bytes | 1 byte |

Total bytes=9

Monitor Registration Perform Request: A data read request for a registered address, received from a monitor registration request

| ENQ | Station ID | CMD | SUM | EOT |
|-----|------------|-----|------|-----|
| 05h | '01'-FA' | 'Y' | 'XX' | 04h |

| ENQ | Station ID | CMD | SUM | EOT |
|--------|------------|--------|---------|--------|
| 1 byte | 2 bytes | 1 byte | 2 bytes | 1 byte |

Total bytes=7

Monitor Registration Execution Normal Response

| ACK | Station ID | CMD | Data | SUM | EOT |
|--------|------------|--------|-------------|---------|--------|
| 06h | '01'-'FA' | 'Y' | 'XXXX...' | 'XX' | 04h |
| 1 byte | 2 bytes | 1 byte | n x 4 bytes | 2 bytes | 1 byte |

Total bytes= (7 + n x 4): a maximum of 39

Monitor Registration Execution Error Response

| NAK | Station ID | CMD | Error Code | SUM | EOT |
|--------|------------|--------|------------|---------|--------|
| 15h | '01'-'FA' | 'Y' | '**' | 'XX' | 04h |
| 1 byte | 2 bytes | 1 byte | 2 bytes | 2 bytes | 1 byte |

Total bytes=9

7.3.1.4 Error Code

| Code | Abbreviation | Description |
|----------------------|--------------|---|
| ILLEGAL FUNCTION | IF | The requested function cannot be performed by a slave because the corresponding function does not exist. |
| ILLEGAL DATA ADDRESS | IA | The received parameter address is invalid at the slave. |
| ILLEGAL DATA VALUE | ID | The received parameter data is invalid at the slave. |
| WRITE MODE ERROR | WM | Tried writing (W) to a parameter that does not allow writing (read-only parameters, or when writing is prohibited during operation) |
| FRAME ERROR | FE | The frame size does not match. |

7.3.1.5 ASCII Code

| Character | Hex | Character | Hex | Character | Hex |
|-----------|-----|-----------|-----|-----------|-----|
| A | 41 | q | 71 | @ | 40 |
| B | 42 | r | 72 | [| 5B |
| C | 43 | s | 73 | \ | 5C |
| D | 44 | t | 74 |] | 5D |
| E | 45 | u | 75 | | 5E |
| F | 46 | v | 76 | | 5F |
| G | 47 | w | 77 | | 60 |
| H | 48 | x | 78 | { | 7B |

| Character | Hex | Character | Hex | Character | Hex |
|-----------|-----|-----------|-----|-----------|-----|
| I | 49 | y | 79 | | 7C |
| J | 4A | z | 7A | } | 7D |
| K | 4B | 0 | 30 | - | 7E |
| L | 4C | 1 | 31 | BEL | 07 |
| M | 4D | 2 | 32 | BS | 08 |
| N | 4E | 3 | 33 | CAN | 18 |
| O | 4F | 4 | 34 | CR | 0D |
| P | 50 | 5 | 35 | DC1 | 11 |
| Q | 51 | 6 | 36 | DC2 | 12 |
| R | 52 | 7 | 37 | DC3 | 13 |
| S | 53 | 8 | 38 | DC4 | 14 |
| T | 54 | 9 | 39 | DEL | 7F |
| U | 55 | space | 20 | DLE | 10 |
| V | 56 | ! | 21 | EM | 19 |
| W | 57 | " | 22 | ACK | 06 |
| X | 58 | # | 23 | ENQ | 05 |
| Y | 59 | \$ | 24 | EOT | 04 |
| Z | 5A | % | 25 | ESC | 1B |
| a | 61 | & | 26 | ETB | 17 |
| b | 62 | ' | 27 | ETX | 03 |
| c | 63 | (| 28 | FF | 0C |
| d | 64 |) | 29 | FS | 1C |
| e | 65 | * | 2A | GS | 1D |
| f | 66 | + | 2B | HT | 09 |
| g | 67 | , | 2C | LF | 0A |
| h | 68 | - | 2D | NAK | 15 |
| i | 69 | . | 2E | NUL | 00 |
| j | 6A | / | 2F | RS | 1E |
| k | 6B | : | 3A | S1 | 0F |
| l | 6C | ; | 3B | SO | 0E |
| m | 6D | < | 3C | SOH | 01 |
| n | 6E | = | 3D | STX | 02 |
| o | 6F | > | 3E | SUB | 1A |
| p | 70 | ? | 3F | SYN | 16 |
| | | | | US | 1F |
| | | | | VT | 0B |

7.3.2 Modbus-RTU Protocol

7.3.2.1 Function Code and Protocol (unit: byte)

In the following section, station ID is the value set at CM.01 (Int485 St ID), and starting address is the communication address. (starting address size is in bytes). For more information about communication addresses, refer to *7.4 Compatible Common Area Parameter* on page 235.

Function Code #03: Read Holding Register

| Query Field Name | Response Field Name |
|---------------------|---------------------|
| Station ID | Station ID |
| Function(0x03) | Function (0x03) |
| Starting Address Hi | Byte Count |
| Starting Address Lo | Data Hi |
| # of Points Hi | Data Lo |
| # of Points Lo | ... |
| CRC Lo | ... |
| CRC Hi | Data Hi |
| | Data Lo |
| | CRC Lo |
| | CRC Hi |

number of Points

Function Code #04: Read Input Register

| Query Field Name | Response Field Name |
|---------------------|---------------------|
| Station ID | Station ID |
| Function(0x04) | Function (0x04) |
| Starting Address Hi | Byte Count |
| Starting Address Lo | Data Hi |
| # of Points Hi | Data Lo |
| # of Points Lo | ... |
| CRC Lo | ... |
| CRC Hi | Data Hi |
| | Data Lo |
| | CRC Lo |
| | CRC Hi |

number of Points

Function Code #06: Preset Single Register

| Query Field Name | Response Field Name |
|---------------------|---------------------|
| Station ID | Station ID |
| Function (0x06) | Function (0x06) |
| Starting Address Hi | Register Address Hi |
| Register Address Lo | Register Address Lo |
| Preset Data Hi | Preset Data Hi |
| Preset Data Lo | Preset Data Lo |
| CRC Lo | CRC Lo |
| CRC Hi | CRC Hi |

Function Code #16 (hex 0h10): Preset Multiple Register

| Query Field Name | Response Field Name |
|---------------------|---------------------|
| Station ID | Station ID |
| Function (0x10) | Function (0x10) |
| Starting Address Hi | Starting Address Hi |
| Starting Address Lo | Starting Address Lo |
| # of Register Hi | # of Register Hi |
| # of Register Lo | # of Register Lo |
| Byte Count | CRC Lo |
| Data Hi | CRC Hi |
| Data Lo | |
| ... | |
| ... | |
| Data Hi | |
| Data Lo | |
| CRC Lo | |
| CRC Hi | |

} # number of Points

Exception Code

| Code |
|--------------------------|
| 01: ILLEGAL FUNCTION |
| 02: ILLEGAL DATA ADDRESS |
| 03: ILLEGAL DATA VALUE |
| 06: SLAVE DEVICE BUSY |

Response

| Field Name |
|----------------|
| Station ID |
| Function* |
| Exception Code |
| CRC Lo |
| CRC Hi |

* The function value uses the top level bit for all query values.

Example of Modbus-RTU Communication in Use

When the Acc time (Communication address 0x1103) is changed to 5.0 sec and the Dec time (Communication address 0x1104) is changed to 10.0 sec.

Frame Transmission from Master to Slave (Request)

| Item | Station ID | Function | Starting Address | # of Register | Byte Count | Data 1 | Data 2 | CRC |
|-------------|--------------------------|--------------------------------|--------------------------------------|---------------|------------|-------------------------------|---------------------------------|--------|
| Hex | 0x01 | 0x10 | 0x1102 | 0x0002 | 0x04 | 0x0032 | 0x0064 | 0x1202 |
| Description | CM.01 Int485 St ID | Preset Multiple Register | Starting Address -1 (0x1103-1) | - | - | 50 (ACC time 5.0sec) | 100 (DEC time 10.0sec) | - |

Frame Transmission from Slave to Master (Response)

| Item | Station ID | Function | Starting Address | # of Register | CRC |
|-------------|-----------------------|-----------------------------|-----------------------------------|---------------|--------|
| Hex | 0x01 | 0x10 | 0x1102 | 0x0002 | 0xE534 |
| Description | CM.01 Int485 St ID | Preset Multiple Register | Starting Address -1 (0x1103-1) | - | - |

7.4 Compatible Common Area Parameter

The following are common area parameters compatible with iS5, iP5A, iV5, and iG5A.

| Comm. Address | Parameter | Scale | Unit | R/W | Assigned Content by Bit | |
|---------------|----------------------------|--|------|-----|---|---------------------------------------|
| 0h0000 | Inverter model | - | - | R | 6: S100 | |
| 0h0001 | Inverter capacity | - | - | R | 0: 0.75 kW, 1: 1.5 kW, 2: 2.2 kW 3: 3.7 kW, 4: 5.5 kW, 5: 7.5 kW 6: 11 kW, 7: 15 kW, 8: 18.5 kW 9: 22 kW 256: 0.4 kW, 257: 1.1 kW, 258: 3.0 kW 259: 4.0 kW | |
| 0h0002 | Inverter input voltage | - | - | R | 0: 220V product 1: 440V product | |
| 0h0003 | Version | - | - | R | Example 0h0100: Version 1.00 Example 0h0101: Version 1.01 | |
| 0h0004 | Reserved | - | - | R/W | | |
| 0h0005 | Command frequency | 0.01 | Hz | R/W | | |
| 0h0006 | Operation command (option) | - | - | R | B15 | Reserved |
| | | | | | B14 | 0: Keypad Freq, |
| | | | | | B13 | 1: Keypad Torq |
| | | | | | B12 | 2-16: Terminal block multi-step speed |
| | | | | | B11 | 17: Up, 18: Down |
| | | | | | B10 | 19: STEADY |
| | | | | B9 | 22: V1, 24: V2, 25: I2, | |
| | | | | | 26: Reserved | |
| | | | | | 27: Built-in 485 | |
| | | | | | 28: Communication option | |
| | | | | B8 | 30: JOG, 31: PID | |
| | | | | | B8 | 0: Keypad |
| | | | | | B7 | 1: Fx/Rx-1 |
| B6 | 2: Fx/Rx-2 | | | | | |
| | 3: Built-in 485 | | | | | |
| R/W | 4: Communication option | | | | | |
| | B5 | Reserved | | | | |
| | B4 | Emergency stop | | | | |
| | B3 | W: Trip initialization (0→1), R: Trip status | | | | |
| | B2 | Reverse operation (R) | | | | |
| | B1 | Forward operation (F) | | | | |
| | B0 | Stop (S) | | | | |
| 0h0007 | Acceleration time | 0.1 | s | R/W | - | |

| Comm. Address | Parameter | Scale | Unit | R/W | Assigned Content by Bit | |
|---------------|--------------------------------|-------|------|-----|-------------------------|---|
| 0h0008 | Deceleration time | 0.1 | s | R/W | - | |
| 0h0009 | Output current | 0.1 | A | R | - | |
| 0h000A | Output frequency | 0.01 | Hz | R | - | |
| 0h000B | Output voltage | 1 | V | R | - | |
| 0h000C | DC link voltage | 1 | V | R | - | |
| 0h000D | Output power | 0.1 | kW | R | - | |
| 0h000E | Operation status | - | - | R | B15 | 0: Remote, 1: Keypad Local |
| | | | | | B14 | 1: Frequency command source by communication (built-in, option) |
| | | | | | B13 | 1: Operation command source by communication (built-in, option) |
| | | | | | B12 | Reverse operation command |
| | | | | | B11 | Forward operation command |
| | | | | | B10 | Brake release signal |
| | | | | | B9 | Jog mode |
| | | | | | B8 | Drive stopped. |
| | | | | | B7 | DC Braking |
| | | | | | B6 | Speed reached |
| | | | | | B5 | Decelerating |
| | | | | | B4 | Accelerating |
| | | | | | B3 | Fault Trip - operates according to Pr.30 setting |
| | | | | | B2 | Operating in reverse direction |
| B1 | Operating in forward direction | | | | | |
| B0 | Stopped | | | | | |
| 0h000F | Fault trip information | - | - | R | B15 | Reserved |
| | | | | | B14 | Reserved |
| | | | | | B13 | Reserved |
| | | | | | B12 | Reserved |
| | | | | | B11 | Reserved |
| | | | | | B10 | H/W-Diag |
| | | | | | B9 | Reserved |
| | | | | | B8 | Reserved |
| | | | | | B7 | Reserved |
| | | | | | B6 | Reserved |
| | | | | | B5 | Reserved |
| | | | | | B4 | Reserved |
| | | | | | B3 | Level Type trip |
| | | | | | B2 | Reserved |
| B1 | Reserved | | | | | |
| B0 | Latch Type trip | | | | | |

| Comm. Address | Parameter | Scale | Unit | R/W | Assigned Content by Bit | |
|-----------------|--|-------|------|-----|--|----------|
| 0h0010 | Input terminal information | - | - | R | B15-B7 | Reserved |
| | | | | | B6 | P7 |
| | | | | | B5 | P6 |
| | | | | | B4 | P5 |
| | | | | | B3 | P4 |
| | | | | | B2 | P3 |
| | | | | | B1 | P2 |
| | | | | | B0 | P1 |
| 0h0011 | Output terminal information | - | - | R | B15 | Reserved |
| | | | | | B14 | Reserved |
| | | | | | B13 | Reserved |
| | | | | | B12 | Reserved |
| | | | | | B11 | Reserved |
| | | | | | B10 | Reserved |
| | | | | | B9 | Reserved |
| | | | | | B8 | Reserved |
| | | | | | B7 | Reserved |
| | | | | | B6 | Reserved |
| | | | | | B5 | Reserved |
| | | | | | B4 | Reserved |
| | | | | | B3 | Reserved |
| | | | | | B2 | Reserved |
| B1 | MO | | | | | |
| B0 | Relay 1 | | | | | |
| 0h0012 | V1 | 0.01 | % | R | V1 input voltage | |
| 0h0013 | V2 | 0.01 | % | R | V2 input voltage | |
| 0h0014 | I2 | 0.01 | % | R | I2 input current | |
| 0h0015 | Motor rotation speed | 1 | rpm | R | Displays existing motor rotation speed | |
| 0h0016 - 0h0019 | Reserved | - | - | - | - | |
| 0h001A | Select Hz/rpm | - | - | R | 0: Hz unit, 1: rpm unit | |
| 0h001B | Display the number of poles for the selected motor | - | - | R | Display the number of poles for the selected motor | |

7.5 S100 Expansion Common Area Parameter

7.5.1 Monitoring Area Parameter (Read Only)

| Comm. Address | Parameter | Scale | Unit | Assigned content by bit | |
|---------------|---|-------|------|--|---|
| 0h0300 | Inverter model | - | - | S100: 0006h | |
| 0h0301 | Inverter capacity | - | - | 0.4 kW: 1900h, 0.75 kW: 3200h 1.1 kW: 4011h, 1.5 kW: 4015h 2.2 kW: 4022h, 3.0 kW: 4030h 3.7 kW: 4037h, 4.0 kW: 4040h 5.5 kW: 4055h, 7.5 kW: 4075h 11 kW: 40B0h, 15 kW: 40F0h 18.5 kW: 4125h, 22 kW: 4160h | |
| 0h0302 | Inverter input voltage/power (Single phase, 3-phase)/cooling method | - | - | 100 V single phase self cooling: 0120h, 200 V 3-phase forced cooling: 0231h 100 V single phase forced cooling: 0121h, 400 V single phase self cooling: 0420h 200 V single phase self cooling: 0220h, 400 V 3-phase self cooling: 0430h 200 V 3-phase self cooling: 0230h, 400 V single phase forced cooling: 0421h 200 V single phase forced cooling: 0221h, 400 V 3-phase forced cooling: 0431h | |
| 0h0303 | Inverter S/W version | - | - | (Ex) 0h0100: Version 1.00 0h0101: Version 1.01 | |
| 0h0304 | Reserved | - | - | - | |
| 0h0305 | Inverter operation state | - | - | B15 | 0: Normal state |
| | | | | B14 | 4: Warning occurred |
| | | | | B13 | 8: Fault occurred [operates according to Pr. 30 (Trip Out Mode) setting.] |
| | | | | B12 | |
| | | | | B11 - | - |
| | | | | B8 | |
| | | | | B7 | 1: Speed searching |
| | | | | B6 | 2: Accelerating |
| | | | | B5 | 3: Operating at constant rate |
| | | | | | 4: Decelerating |

| Comm. Address | Parameter | Scale | Unit | Assigned content by bit | |
|---------------|--|-------|------|------------------------------------|---|
| | | | | B4 | 5: Decelerating to stop 6: H/W OCS 7: S/W OCS 8: Dwell operating |
| | | | | B3 | 0: Stopped |
| | | | | B2 | 1: Operating in forward direction |
| | | | | B1 | 2: Operating in reverse direction |
| | | | | B0 | 3: DC operating (0 speed control) |
| 0h0306 | Inverter operation frequency command source | - | - | B15 | Operation command source |
| | | | | B14 | 0: Keypad |
| | | | | B13 | 1: Communication option |
| | | | | B12 | 2: User Sequence |
| | | | | B11 | 3: Built-in RS 485 |
| | | | | B10 | 4: Terminal block |
| | | | | B9 | |
| | | | | B8 | |
| | | | | B7 | Frequency command source |
| | | | | B6 | 0: Keypad speed |
| | | | | B5 | 1: Keypad torque |
| | | | | B4 | 2-4: Up/Down operation speed |
| | | | | B3 | 5: V1, 7: V2, 8: I2 |
| | | | | B2 | 9: Pulse |
| | | | | B1 | 10: Built-in RS 485 |
| B0 | 11: Communication option 12: User Sequence 13: Jog 14: PID 25-39: Multi-step speed frequency | | | | |
| 0h0307 | LCD keypad S/W version | - | - | (Ex.) 0h0100: Version 1.00 | |
| 0h0308 | LCD keypad title version | - | - | (Ex.) 0h0101: Version 1.01 | |
| 0h0309-0h30F | Reserved | - | - | - | |
| 0h0310 | Output current | 0.1 | A | - | |
| 0h0311 | Output frequency | 0.01 | Hz | - | |
| 0h0312 | Output rpm | 0 | rpm | - | |
| 0h0313 | Motor feedback speed | 0 | rpm | -32768 rpm-32767 rpm (directional) | |
| 0h0314 | Output voltage | 1 | V | - | |
| 0h0315 | DC Link voltage | 1 | V | - | |
| 0h0316 | Output power | 0.1 | kW | - | |
| 0h0317 | Output torque | 0.1 | % | - | |

| Comm. Address | Parameter | Scale | Unit | Assigned content by bit | |
|-----------------|---|-------|------|---|---------------------|
| 0h0318 | PID reference | 0.1 | % | - | |
| 0h0319 | PID feedback | 0.1 | % | - | |
| 0h031A | Display the number of poles for the 1 st motor | - | - | Displays the number of poles for the first motor | |
| 0h031B | Display the number of poles for the 2 nd motor | - | - | Displays the number of poles for the 2nd motor | |
| 0h031C | Display the number of poles for the selected motor | - | - | Displays the number of poles for the selected motor | |
| 0h031D | Select Hz/rpm | - | - | 0: Hz, 1: rpm | |
| 0h031E - 0h031F | Reserved | - | - | - | |
| 0h0320 | Digital input information | | | B15 | Reserved |
| | | | | - | - |
| | | | | B7 | Reserved |
| | | | | B6 | P7(I/O board) |
| | | | | B5 | P6(I/O board) |
| | | | | B4 | P5(I/O board) |
| | | | | B3 | P4(I/O board) |
| | | | | B2 | P3(I/O board) |
| | | | | B1 | P2(I/O board) |
| B0 | P1(I/O board) | | | | |
| 0h0321 | Digital output information | | | B15 | Reserved |
| | | | | - | Reserved |
| | | | | B4 | Reserved |
| | | | | B3 | Reserved |
| | | | | B2 | Reserved |
| | | | | B1 | Q1 |
| B0 | Relay 1 | | | | |
| 0h0322 | Virtual digital input information | | | B15 | Reserved |
| | | | | - | Reserved |
| | | | | B8 | Reserved |
| | | | | B7 | Virtual DI 8(CM.77) |
| | | | | B6 | Virtual DI 7(CM.76) |
| | | | | B5 | Virtual DI 6(CM.75) |
| | | | | B4 | Virtual DI 5(CM.74) |
| | | | | B3 | Virtual DI 4(CM.73) |
| | | | | B2 | Virtual DI 3(CM.72) |
| B1 | Virtual DI 2(CM.71) | | | | |
| B0 | Virtual DI 1(CM.70) | | | | |
| 0h0323 | Display the | - | - | 0: 1st motor/1: 2nd motor | |

| Comm. Address | Parameter | Scale | Unit | Assigned content by bit | |
|---------------|---------------------------------|-------|------|-----------------------------|--|
| | selected motor | | | | |
| 0h0324 | AI1 | 0.01 | % | Analog input V1 (I/O board) | |
| 0h0325 | Reserved | 0.01 | % | | |
| 0h0326 | AI3 | 0.01 | % | Analog input V2 (I/O board) | |
| 0h0327 | AI4 | 0.01 | % | Analog input I2 (I/O board) | |
| 0h0328 | AO1 | 0.01 | % | Analog output 1 (I/O board) | |
| 0h0329 | AO2 | 0.01 | % | Analog output 2 (I/O board) | |
| 0h032A | AO3 | 0.01 | % | Reserved | |
| 0h032B | AO4 | 0.01 | % | Reserved | |
| 0h032C | Reserved | - | - | - | |
| 0h032D | Inverter module temperature | 1 | °C | - | |
| 0h032E | Inverter power consumption | 1 | kWh | - | |
| 0h032F | Inverter power consumption | 1 | MWh | - | |
| 0h0330 | Latch type trip information - 1 | - | - | B15 | Fuse Open Trip |
| | | | | B14 | Over Heat Trip |
| | | | | B13 | Arm Short |
| | | | | B12 | External Trip |
| | | | | B11 | Overvoltage Trip |
| | | | | B10 | Overcurrent Trip |
| | | | | B9 | NTC Trip |
| | | | | B8 | Reserved |
| | | | | B7 | Reserved |
| | | | | B6 | Input open-phase trip |
| | | | | B5 | Output open-phase trip |
| | | | | B4 | Ground Fault Trip |
| | | | | B3 | E-Thermal Trip |
| B2 | Inverter Overload Trip | | | | |
| B1 | Underload Trip | | | | |
| B0 | Overload Trip | | | | |
| 0h0331 | Latch type trip information - 2 | - | - | B15 | Reserved |
| | | | | B14 | Reserved |
| | | | | B13 | Safety option to block inverter output at the terminal block input (only for products rated at 90 kW and above). |
| | | | | B12 | Reserved |
| | | | | B11 | Reserved |
| | | | | B10 | Bad option card |
| | | | | B9 | No motor trip |
| B8 | External brake trip | | | | |

| Comm. Address | Parameter | Scale | Unit | Assigned content by bit | |
|---------------|--------------------------------|-------|------|-------------------------|--------------------------------|
| | | | | B7 | Bad contact at basic I/O board |
| | | | | B6 | Pre PID Fail |
| | | | | B5 | Error while writing parameter |
| | | | | B4 | Reserved |
| | | | | B3 | FAN Trip |
| | | | | B2 | PTC (Thermal sensor) Trip |
| | | | | B1 | Reserved |
| | | | | B0 | MC Fail Trip |
| 0h0332 | Level type trip information | - | - | B15 | Reserved |
| | | | | - | - |
| | | | | B8 | Reserved |
| | | | | B7 | Reserved |
| | | | | B6 | Reserved |
| | | | | B5 | SafetyB |
| | | | | B4 | SafetyA |
| | | | | B3 | Keypad Lost Command |
| | | | | B2 | Lost Command |
| | | | | B1 | LV |
| | | | | B0 | BX |
| 0h0333 | H/W Diagnosis Trip information | - | - | B15 | Reserved |
| | | | | - | Reserved |
| | | | | B6 | Reserved |
| | | | | B5 | Queue Full |
| | | | | B4 | Reserved |
| | | | | B3 | Watchdog-2 error |
| | | | | B2 | Watchdog-1 error |
| | | | | B1 | EEPROM error |
| | | | | B0 | ADC error |
| 0h0334 | Warning information | - | - | B15 | Reserved |
| | | | | - | Reserved |
| | | | | B10 | Reserved |
| | | | | B9 | Auto Tuning failed |
| | | | | B8 | Keypad lost |
| | | | | B7 | Encoder disconnection |
| | | | | B6 | Wrong installation of encoder |
| | | | | B5 | DB |
| | | | | B4 | FAN running |
| | | | | B3 | Lost command |
| | | | | B2 | Inverter Overload |
| | | | | B1 | Underload |

| Comm. Address | Parameter | Scale | Unit | Assigned content by bit | |
|----------------|-----------------|-------|------|---|----------|
| | | | | B0 | Overload |
| 0h0335 -0h033F | Reserved | - | - | - | |
| 0h0340 | On Time date | 0 | Day | Total number of days the inverter has been powered on | |
| 0h0341 | On Time minute | 0 | Min | Total number of minutes excluding the total number of On Time days | |
| 0h0342 | Run Time date | 0 | Day | Total number of days the inverter has driven the motor | |
| 0h0343 | Run Time minute | 0 | Min | Total number of minutes excluding the total number of Run Time days | |
| 0h0344 | Fan Time date | 0 | Day | Total number of days the heat sink fan has been running | |
| 0h0345 | Fan Time minute | 0 | Min | Total number of minutes excluding the total number of Fan Time days | |
| 0h0346 -0h0348 | Reserved | - | - | - | |
| 0h0349 | Reserved | - | - | - | |
| 0h034A | Option 1 | - | - | 0: None, 9: CANopen | |
| 0h034B | Reserved | - | - | | |
| 0h034C | Reserved | | | | |

7.5.2 Control Area Parameter (Read/ Write)

| Comm. Address | Parameter | Scale | Unit | Assigned Content by Bit | |
|---------------|-------------------|-------|------|---------------------------|--|
| 0h0380 | Frequency command | 0.01 | Hz | Command frequency setting | |
| 0h0381 | RPM command | 1 | rpm | Command rpm setting | |
| 0h0382 | Operation command | - | - | B7 | Reserved |
| | | | | B6 | Reserved |
| | | | | B5 | Reserved |
| | | | | B4 | Reserved |
| | | | | B3 | 0 → 1: Free-run stop |
| | | | | B2 | 0 → 1: Trip initialization |
| | | | | B1 | 0: Reverse command, 1: Forward command |
| | | | | B0 | 0: Stop command, 1: Run command |

| Comm. Address | Parameter | Scale | Unit | Assigned Content by Bit | |
|---------------|--|-------|------|--|---------------------|
| | | | | Example: Forward operation command 0003h, Reverse operation command 0001h | |
| 0h0383 | Acceleration time | 0.1 | s | Acceleration time setting | |
| 0h0384 | Deceleration time | 0.1 | s | Deceleration time setting | |
| 0h0385 | Virtual digital input control (0: Off, 1:On) | - | - | B15 | Reserved |
| | | | | - | Reserved |
| | | | | B8 | Reserved |
| | | | | B7 | Virtual DI 8(CM.77) |
| | | | | B6 | Virtual DI 7(CM.76) |
| | | | | B5 | Virtual DI 6(CM.75) |
| | | | | B4 | Virtual DI 5(CM.74) |
| | | | | B3 | Virtual DI 4(CM.73) |
| | | | | B2 | Virtual DI 3(CM.72) |
| | | | | B1 | Virtual DI 2(CM.71) |
| B0 | Virtual DI 1(CM.70) | | | | |
| 0h0386 | Digital output control (0:Off, 1:On) | - | - | B15 | Reserved |
| | | | | B14 | Reserved |
| | | | | B13 | Reserved |
| | | | | B12 | Reserved |
| | | | | B11 | Reserved |
| | | | | B10 | Reserved |
| | | | | B9 | Reserved |
| | | | | B8 | Reserved |
| | | | | B7 | Reserved |
| | | | | B6 | Reserved |
| | | | | B5 | Reserved |
| | | | | B4 | Reserved |
| | | | | B3 | Reserved |
| | | | | B2 | Reserved |
| B1 | Q1 (I/O board, OU.33: None) | | | | |
| B0 | Relay 1 (I/O board, OU.31: None) | | | | |
| 0h0387 | Reserved | - | - | Reserved | |
| 0h0388 | PID reference | 0.1 | % | PID reference command | |
| 0h0389 | PID feedback value | 0.1 | % | PID feedback value | |
| 0h038A | Motor rated current | 0.1 | A | - | |
| 0h038B | Motor rated voltage | 1 | V | - | |
| 0h038C-0h038F | Reserved | | | - | |
| 0h0390 | Torque Ref | 0.1 | % | Torque command | |

| Comm. Address | Parameter | Scale | Unit | Assigned Content by Bit |
|---------------|----------------------|-------|------|---|
| 0h0391 | Fwd Pos Torque Limit | 0.1 | % | Forward motoring torque limit |
| 0h0392 | Fwd Neg Torque Limit | 0.1 | % | Forward regenerative torque limit |
| 0h0393 | Rev Pos Torque Limit | 0.1 | % | Reverse motoring torque limit |
| 0h0394 | Rev Neg Torque Limit | 0.1 | % | Reverse regenerative torque limit |
| 0h0395 | Torque Bias | 0.1 | % | Torque bias |
| 0h0396- 0h399 | Reserved | - | - | - |
| 0h039A | Anytime Para | - | - | Set the CNF.20* value (refer to 5.36 Operation State Monitor on page 193) |
| 0h039B | Monitor Line-1 | - | - | Set the CNF.21* value (refer to 5.36 Operation State Monitor on page 193) |
| 0h039C | Monitor Line-2 | - | - | Set the CNF.22* value (refer to 5.36 Operation State Monitor on page 193) |
| 0h039D | Monitor Line-3 | - | - | Set the CNF.23* value (refer to 5.36 Operation State Monitor on page 193) |

* Displayed on an LCD keypad only.

Note

A frequency set via communication using the common area frequency address (0h0380, 0h0005) is not saved even when used with the parameter save function. To save a changed frequency to use after a power cycle, follow these steps:

- 1 Set dr.07 to Keypad-1 and select a random target frequency.
- 2 Set the frequency via communication into the parameter area frequency address (0h1101).
- 3 Perform the parameter save (0h03E0: '1') before turning off the power. After the power cycle, the frequency set before turning off the power is displayed.

7.5.3 Inverter Memory Control Area Parameter (Read and Write)

| Comm. Address | Parameter | Scale | Unit | Changeable During Operation | Function |
|---------------|-----------------------------|-------|------|-----------------------------|-------------------------------|
| 0h03E0 | Save parameters | - | - | X | 0: No, 1:Yes |
| 0h03E1 | Monitor mode initialization | - | - | O | 0: No, 1:Yes |
| 0h03E2 | Parameter | - | - | X | 0: No, 1: All Grp, 2: Drv Grp |

| Comm. Address | Parameter | Scale | Unit | Changeable During Operation | Function |
|---------------|---|-------|------|-----------------------------|---|
| | initialization | | | | 3: bA Grp, 4: Ad Grp, 5: Cn Grp 6: In Grp, 7: OU Grp, 8: CM Grp 9: AP Grp, 12: Pr Grp, 13: M2 Grp Setting is prohibited during fault trip interruptions. |
| 0h03E3 | Display changed parameters | - | - | 0 | 0: No, 1: Yes |
| 0h03E4 | Reserved | - | - | - | - |
| 0h03E5 | Delete all fault history | - | - | 0 | 0: No, 1: Yes |
| 0h03E6 | Delete user-registered codes | - | - | 0 | 0: No, 1: Yes |
| 0h03E7 | Hide parameter mode | 0 | Hex | 0 | Write: 0-9999 Read: 0: Unlock, 1: Lock |
| 0h03E8 | Lock parameter mode | 0 | Hex | 0 | Write: 0-9999 Read: 0: Unlock, 1: Lock |
| 0h03E9 | Easy start on (easy parameter setup mode) | - | - | 0 | 0: No, 1: Yes |
| 0h03EA | Initializing power consumption | - | - | 0 | 0: No, 1: Yes |
| 0h03EB | Initialize inverter operation accumulative time | - | - | 0 | 0: No, 1: Yes |
| 0h03EC | Initialize cooling fan accumulated operation time | - | - | 0 | 0: No, 1: Yes |

Note

- When setting parameters in the inverter memory control area, the values are reflected to the inverter operation and saved. Parameters set in other areas via communication are reflected to the inverter operation, but are not saved. All set values are cleared following an inverter power cycle and revert back to its previous values. When setting parameters via communication, ensure that a parameter save is completed prior to shutting the inverter down.
- Set parameters very carefully. After setting a parameter to 0 via communication, set it to another value. If a parameter has been set to a value other than 0 and a non-zero value is entered again, an error message is returned. The previously-set value can be identified by reading the parameter when operating the inverter via communication.

- The addresses 0h03E7 and 0h03E8 are parameters for entering the password. When the password is entered, the condition will change from Lock to Unlock, and vice versa. When the same parameter value is entered continuously, the parameter is executed just once. Therefore, if the same value is entered again, change it to another value first and then re-enter the previous value. For example, if you want to enter 244 twice, enter it in the following order: 244 → 0 → 244.

⚠ Caution

It may take longer to set the parameter values in the inverter memory control area because all data is saved to the inverter. Be careful as communication may be lost during parameter setup if parameter setup is continued for an extended period of time.

8 Table of Functions

This chapter lists all the function settings for S100 series inverter. Set the parameters required according to the following references. If a set value input is out of range, the following messages will be displayed on the keyboard. In these cases, the inverter will not operate with the [ENT] key.

- Set value not allocated: **rd**
- Set value repetition (multi-function input, PID reference, PID feedback related): **OL**
- Set value not allowed (select value, V2, I2): **no**

8.1 Operation Group

The Operation group is used only in the basic keypad mode. It will not be displayed on an LCD keypad. If the LCD keypad is connected, the corresponding functions will be found in the Drive(DRV) group.

SL: Sensorless vector control (dr.09)

***O/X:** Write-enabled during operation, **7/L/A:** Keypad/LCD keypad/Common

| Code | Comm. Address | Name | Keypad Display | Setting Range | Initial Value | Property* | V/F | SL | Ref. | |
|------|---------------|----------------------------|----------------|-------------------------|------------------------|-------------|-----|----|----------------------|----------------------|
| | 0h1F00 | Target frequency | 0.00 | 0-Maximum frequency(Hz) | 0.00 | O/7 | O | O | p.48 | |
| - | 0h1F01 | Acceleration time | ACC | 0.0-600.0(s) | 20.0 | O/7 | O | O | p.87 | |
| - | 0h1F02 | Deceleration time | dEC | 0.0-600.0(s) | 30.0 | O/7 | O | O | p.87 | |
| - | 0h1F03 | Command source | drv | 0 | Keypad | 1: Fx/Rx-1 | X/7 | O | O | p.80 |
| | | | | 1 | Fx/Rx-1 | | | | | |
| | | | | 2 | Fx/Rx-2 | | | | | |
| | | | | 3 | Int 485 | | | | | |
| | | | | 4 | Field Bus ¹ | | | | | |
| - | 0h1F04 | Frequency reference source | Frq | 0 | Keypad-1 | 0: Keypad-1 | X/7 | O | O | p.66 |
| | | | | 1 | Keypad-2 | | | | | |
| | | | | 2 | V1 | | | | | |
| | | | | 4 | V2 | | | | | |
| | | | | 5 | I2 | | | | | |
| | | | | 6 | Int 485 | | | | | |

¹ Table of options are provided separately in the option manual.

Table of Functions

| Code | Comm. Address | Name | Keypad Display | Setting Range | | Initial Value | Property* | V/F | SL | Ref. |
|------|---------------|---------------------------------|----------------|----------------------------|-------------|---------------|-----------|-----|----|----------------------|
| | | | | 8 | Field Bus | | | | | |
| | | | | 12 | Pulse | | | | | |
| - | 0h1F05 | Multi-step speed frequency 1 | St1 | 0.00-Maximum frequency(Hz) | | 10.00 | O/7 | O | O | p.77 |
| - | 0h1F06 | Multi-step speed frequency 2 | St2 | 0.00-Maximum frequency(Hz) | | 20.00 | O/7 | O | O | p.77 |
| - | 0h1F07 | Multi-step speed frequency 3 | St3 | 0.00-Maximum frequency(Hz) | | 30.00 | O/7 | O | O | p.77 |
| - | 0h1F08 | Output current | CUr | | | | -/7 | O | O | p.60 |
| - | 0h1F09 | Motor revolutions per minute | Rpm | | | | -/7 | O | O | - |
| - | 0h1F0A | Inverter direct current voltage | dCL | - | | - | -/7 | O | O | p.60 |
| - | 0h1F0B | Inverter output voltage | vOL | | | | -/7 | O | O | p.60 |
| - | 0h1F0C | Out of order signal | nOn | | | | -/7 | O | O | - |
| - | 0h1F0D | Select rotation direction | drC | F | Forward run | F | O/7 | O | O | - |
| | | | | r | Reverse run | | | | | |

8.2 Drive group (PAR→dr)

In the following table, data shaded in grey will be displayed when the related code has been selected.

SL: Sensorless vector control (dr.09)

***O/X:** Write-enabled during operation, **7/L/A:** Keypad/LCD keypad/Common

| Code | Comm. Address | Name | LCD Display | Setting Range | Initial value | Property* | V/F | SL | Ref. |
|-----------------|---------------|----------------------------|---------------|---|---------------|-----------|-----|----|----------------------|
| 00 | - | Jump Code | Jump Code | 1-99 | 9 | O/A | O | O | p.48 |
| 01 ² | 0h1101 | Target frequency | Cmd Frequency | Start frequency - Maximum frequency(Hz) | 0.00 | O/L | O | O | p.52 |
| 02 | 0h1102 | Torque command | Cmd Torque | -180~180[%] | 0.0 | O/A | X | O | - |
| 03 ² | 0h1103 | Acceleration time | Acc Time | 0.0-600.0(s) | 20.0 | O/L | O | O | p.87 |
| 04 ² | 0h1104 | Deceleration time | Dec Time | 0.0-600.0(s) | 30.0 | O/L | O | O | p.87 |
| 06 ² | 0h1106 | Command source | Cmd Source | 0 Keypad 1 Fx/Rx-1 2 Fx/Rx-2 3 Int 485 4 Field Bus 5 UserSeqLink | 1: Fx/Rx-1 | X/L | O | O | p.80 |
| 07 ² | 0h1107 | Frequency reference source | Freq Ref Src | 0 Keypad-1 1 Keypad-2 2 V1 4 V2 5 I2 6 Int 485 8 Field Bus 9 UserSeqLink 12 Pulse | 0: Keypad-1 | X/L | O | O | p.66 |
| 08 | 0h1108 | Torque reference setting | Trq Ref Src | 0 Keypad-1 1 Keypad-2 2 V1 4 V2 5 I2 | 0: Keypad-1 | X/A | X | O | - |

² Displayed when an LCD keypad is in use.

Table of Functions

| Code | Comm. Address | Name | LCD Display | Setting Range | | Initial value | Property* | V/F | SL | Ref. |
|------|---------------|---------------------------|----------------|--|---------------|--------------------------|-----------|-----|----|--|
| | | | | | | | | | | |
| | | | | 6 | Int 485 | | | | | |
| | | | | 8 | FieldBus | | | | | |
| | | | | 9 | UserSeqLink | | | | | |
| | | | | 12 | Pulse | | | | | |
| 09 | 0h1109 | Control mode | Control Mode | 0 | V/F | 0: V/F | X/A | O | O | p.94 , p.134 , p.147 |
| | | | | 2 | Slip Compen | | | | | |
| | | | | 4 | IM Sensorless | | | | | |
| 10 | 0h110A | Torque Control | Torque Control | 0 | No | 0: No | X/A | X | O | - |
| | | | | 1 | Yes | | | | | |
| 11 | 0h110B | Jog frequency | Jog Frequency | 0.00, Start frequency-Maximum frequency(Hz) | | 10.00 | O/A | O | O | p.126 |
| 12 | 0h110C | Jog run acceleration time | Jog Acc Time | 0.0-600.0(s) | | 20.0 | O/A | O | O | p.126 |
| 13 | 0h110D | Jog run deceleration time | Jog Dec Time | 0.0-600.0(s) | | 30.0 | O/A | O | O | p.126 |
| 14 | 0h110E | Motor capacity | Motor Capacity | 0: 0.2kW, 1: 0.4kW 2: 0.75kW, 3: 1.1kW 4: 1.5kW, 5: 2.2kW 6: 3.0kW, 7: 3.7kW 8: 4.0kW, 9: 5.5kW 10: 7.5kW, 11: 11.0kW 12: 15.0kW, 13: 18.5kW 14: 22.0kW, 15: 30.0kW | | Varies by Motor capacity | X/A | O | O | p.144 |
| 15 | 0h110F | Torque boost options | Torque Boost | 0 | Manual | 0: Manual | X/A | O | X | - |
| | | | | 1 | Auto1 | | | | | |
| | | | | 2 | Auto2 | | | | | |

| Code | Comm. Address | Name | LCD Display | Setting Range | Initial value | Property* | V/F | SL | Ref. |
|-----------------|---------------|------------------------------|---------------|---|------------------|-----------|-----|----|-----------------------|
| 16 ³ | 0h1110 | Forward Torque boost | Fwd Boost | 0.0-15.0(%) | 2.0 | X/A | O | X | p.97 |
| 17 ³ | 0h1111 | Reverse Torque boost | Rev Boost | 0.0-15.0(%) | 2.0 | X/A | O | X | p.97 |
| 18 | 0h1112 | Base frequency | Base Freq | 30.00-400.00(Hz) | 60.00 | X/A | O | O | p.94 |
| 19 | 0h1113 | Start frequency | Start Freq | 0.01-10.00(Hz) | 0.50 | X/A | O | O | p.94 |
| 20 | 0h1114 | Maximum frequency | Max Freq | 40.00-400.00(Hz)[V/F, Slip Compen] 40.00-120.00(Hz)[IM Sensorless] | 60.00 | X/A | O | O | p.104 |
| 21 | 0h1115 | Select speed unit | Hz/Rpm Sel | 0 Hz Display 1 Rpm Display | 0:Hz Display | O/L | O | O | p.77 |
| 22 ⁴ | 0h1116 | (+)Torque gain | (+)Trq Gain | 50.0 ~ 150.0[%] | 100.0 | O/A | X | O | - |
| 23 ⁴ | 0h1117 | (-)Torque gain | (-)Trq Gain | 50.0 ~ 150.0[%] | 100.0 | O/A | X | O | - |
| 24 ⁴ | 0h1118 | (-)Torque gain 0 | (-)Trq Gain0 | 50.0 ~ 150.0[%] | 80.0 | O/A | X | O | - |
| 25 ⁴ | 0h1119 | (-)Torque offset | (-)Trq Offset | 0.0 ~ 100.0[%] | 40.0 | O/A | X | O | - |
| 80 ⁵ | 0h1150 | Select ranges at power input | - | Select ranges inverter displays at power input 0 Run frequency 1 Acceleration time 2 Deceleration time 3 Command source 4 Frequency reference source | 0: run frequency | O/7 | O | O | - |

³ Displayed when dr.15 is set to 0 (Manual) or 2(Auto2)

⁴ Displayed when dr.10 is set to 1 (YES)

⁵ Will not be displayed when an LCD keypad is in use

Table of Functions

| Code | Comm. Address | Name | LCD Display | Setting Range | Initial value | Property* | V/F | SL | Ref. |
|-----------------|---------------|---------------------|-------------|-----------------------------|------------------------------|-----------|-----|----|------|
| | | | | 5 | Multi-step speed frequency 1 | | | | |
| | | | | 6 | Multi-step speed frequency 2 | | | | |
| | | | | 7 | Multi-step speed frequency 3 | | | | |
| | | | | 8 | Output current | | | | |
| | | | | 9 | Motor RPM | | | | |
| | | | | 10 | Inverter DC voltage | | | | |
| | | | | 11 | User select signal (dr.81) | | | | |
| | | | | 12 | Currently out of order | | | | |
| | | | | 13 | Select run direction | | | | |
| | | | | 14 | output current2 | | | | |
| | | | | 15 | Motor RPM2 | | | | |
| | | | | 16 | Inverter DC voltage2 | | | | |
| | | | | 17 | User select signal2 (dr.81) | | | | |
| 81 ⁵ | 0h1151 | Select monitor code | - | Monitors user selected code | 0: output voltage | 0/7 | 0 | 0 | - |
| | | | | 0 | Output voltage(V) | | | | |
| | | | | 1 | Output electric power(kW) | | | | |
| | | | | 2 | Torque(kgf · m) | | | | |

| Code | Comm. Address | Name | LCD Display | Setting Range | | Initial value | Property* | V/F | SL | Ref. |
|-----------------|---------------|-------------------------------|-------------|---------------|--------------------------|---------------|-----------|-----|----|---|
| 89 ⁵ | 0h03E3 | Display changed parameter | - | 0 | View All | 0: View All | O/7 | O | O | p.174 |
| | | | | 1 | View Changed | | | | | |
| 90 ⁵ | 0h115A | [ESC] key functions | - | 0 | Move to initial position | 0: None | X/7 | O | O | p.50, p.82, p.128 |
| | | | | 1 | JOG Key | | | | | |
| | | | | 2 | Local/Remote | | | | | |
| 91 | 0h115B | Smart copy | SmartCopy | 0 | None | 0:None | X/A | O | O | - |
| | | | | 1 | SmartDownload | | | | | |
| | | | | 3 | SmartUpload | | | | | |
| 93 ⁵ | 0h115D | Parameter initialization | - | 0 | No | 0:No | X/7 | O | O | p.171 |
| | | | | 1 | All Grp | | | | | |
| | | | | 2 | dr Grp | | | | | |
| | | | | 3 | bA Grp | | | | | |
| | | | | 4 | Ad Grp | | | | | |
| | | | | 5 | Cn Grp | | | | | |
| | | | | 6 | In Grp | | | | | |
| | | | | 7 | OU Grp | | | | | |
| | | | | 8 | CM Grp | | | | | |
| | | | | 9 | AP Grp | | | | | |
| | | | | 12 | Pr Grp | | | | | |
| | | | | 13 | M2 Grp | | | | | |
| | | | | 16 | run Grp | | | | | |
| 94 ⁵ | 0h115E | Password registration | | 0-99 | | | O/7 | O | O | p.172 |
| 95 ⁵ | 0h115F | Parameter lock settings | | 0-99 | | | O/7 | O | O | p.173 |
| 97 ⁵ | 0h1161 | Software version | - | | | | -/7 | O | O | - |
| 98 | 0h1162 | Display I/O board version | IO S/W Ver | | | | -/A | O | O | - |
| 99 | 0h1163 | Display I/O board H/W version | IO H/W Ver | 0 | Multiple IO | Standard IO | -/A | O | O | - |
| | | | | 1 | Standard IO | | | | | |
| | | | | 2 | Standard IO (M) | | | | | |

8.3 Basic Function group (PAR→bA)

In the following table, the data shaded in grey will be displayed when a related code has been selected.

SL: Sensorless vector control function (dr.09)

***O/X:** Write-enabled during operation, **7/L/A:** Keypad/LCD keypad/Common

| Code | Comm. Address | Name | LCD Display | Setting Range | Initial Value | Property* | V/F | SL | Ref. | |
|-----------------|---------------|------------------------------------|---------------|-----------------|----------------|-------------|-----|----|-----------------------|-----------------------|
| 00 | - | Jump Code | Jump Code | 1-99 | 20 | O | O | O | p.48 | |
| 01 | 0h1201 | Auxiliary reference source | Aux Ref Src | 0 | None | 0:None | X/A | O | O | p.122 |
| | | | | 1 | V1 | | | | | |
| | | | | 3 | V2 | | | | | |
| | | | | 4 | I2 | | | | | |
| | | | | 6 | Pulse | | | | | |
| 02 ⁶ | 0h1202 | Auxiliary command calculation type | Aux Calc Type | 0 | M+(G*A) | 0: M+(GA) | X/A | O | O | p.122 |
| | | | | 1 | Mx (G*A) | | | | | |
| | | | | 2 | M/(G*A) | | | | | |
| | | | | 3 | M+[M*(G*A)] | | | | | |
| | | | | 4 | M+G*2(A-50%) | | | | | |
| | | | | 5 | Mx[G*2(A-50%) | | | | | |
| | | | | 6 | M/[G*2(A-50%)] | | | | | |
| | | | | 7 | M+M*G*2(A-50%) | | | | | |
| 03 ⁶ | 0h1203 | Auxiliary command gain | Aux Ref Gain | -200.0-200.0(%) | 100.0 | O/A | O | O | p.122 | |
| 04 | 0h1204 | 2nd command source | Cmd 2nd Src | 0 | Keypad | 1: Fx/Rx-1 | X/A | O | O | p.106 |
| | | | | 1 | Fx/Rx-1 | | | | | |
| | | | | 2 | Fx/Rx-2 | | | | | |
| | | | | 3 | Int 485 | | | | | |
| | | | | 4 | FieldBus | | | | | |
| 05 | 0h1205 | 2nd frequency source | Freq 2nd Src | 0 | Keypad-1 | 0: Keypad-1 | O/A | O | O | p.106 |
| | | | | 1 | Keypad-2 | | | | | |
| | | | | 2 | V1 | | | | | |
| | | | | 4 | V2 | | | | | |
| | | | | 5 | I2 | | | | | |
| | | | | 6 | Int 485 | | | | | |
| | | | | 8 | FieldBus | | | | | |
| | | | | 9 | UserSeqLink | | | | | |
| | | | | 12 | Pulse | | | | | |

⁶ Displayed if bA.01 is not set to 0 (None).

| Code | Comm. Address | Name | LCD Display | Setting Range | Initial Value | Property* | V/F | SL | Ref. | |
|------|---------------|----------------------------|---------------|---------------|----------------|----------------------------|-----|-----|------|-----------------------|
| 06 | 0h1206 | 2nd Torque command source | Trq 2nd Src | 0 | Keypad-1 | 0: Keypad -1 | O | X | O | |
| | | | | 1 | Keypad-2 | | | | | |
| | | | | 2 | V1 | | | | | |
| | | | | 4 | V2 | | | | | |
| | | | | 5 | I2 | | | | | |
| | | | | 6 | Int 485 | | | | | |
| | | | | 8 | FieldBus | | | | | |
| | | | | 9 | UserSeqLink | | | | | |
| 07 | 0h1207 | V/F pattern options | V/F Pattern | 0 | Linear | 0: Linear | X/A | O | X | p.94 |
| | | | | 1 | Square | | | | | |
| | | | | 2 | User V/F | | | | | |
| | | | | 3 | Square 2 | | | | | |
| 08 | 0h1208 | Acc/dec standard frequency | Ramp T Mode | 0 | Max Freq | 0: Max Freq | X/A | O | O | p.87 |
| | | | | 1 | Delta Freq | | | | | |
| 09 | 0h1209 | Time scale settings | Time Scale | 0 | 0.01 sec | 1:0.1 sec | X/A | O | O | p.87 |
| | | | | 1 | 0.1 sec | | | | | |
| | | | | 2 | 1 sec | | | | | |
| 10 | 0h120A | Input power frequency | 60/50 Hz Sel | 0 | 60Hz | 0:60Hz | X/A | O | O | p.170 |
| | | | | 1 | 50Hz | | | | | |
| 11 | 0h120B | Number of motor poles | Pole Number | 2-48 | | Dependent on motor setting | X/A | O | O | p.134 |
| 12 | 0h120C | Rated slip speed | Rated Slip | 0-3000(Rpm) | | | X/A | O | O | p.134 |
| 13 | 0h120D | Motor rated current | Rated Curr | 1.0-1000.0(A) | | | X/A | O | O | p.134 |
| 14 | 0h120E | Motor noload current | Noload Curr | 0.0-1000.0(A) | | | X/A | O | O | p.134 |
| 15 | 0h120F | Motor rated voltage | Rated Volt | 170-480(V) | | | 0 | X/A | O | O |
| 16 | 0h1210 | Motor efficiency | Efficiency | 70-100(%) | | Dependent on motor setting | X/A | O | O | p.134 |
| 17 | 0h1211 | Load inertia rate | Inertia Rate | 0-8 | | | X/A | O | O | p.134 |
| 18 | 0h1212 | Trim power display | Trim Power % | 70-130(%) | | | O/A | O | O | - |
| 19 | 0h1213 | Input power voltage | AC Input Volt | 170-480V | | 220/380V | O/A | O | O | p.170 |
| 20 | - | Auto Tuning | Auto Tuning | 0 | None | 0:None | X/A | X | O | p.144 |
| | | | | 1 | All (Rotation) | | | | | |

Table of Functions

| Code | Comm. Address | Name | LCD Display | Setting Range | Initial Value | Property* | V/F | SL | Ref. |
|-----------------|---------------|-------------------------------|----------------|---------------------------------|----------------------------|-----------|-----|----|-----------------------|
| | | | | type) | | | | | |
| | | | | 2 ALL (Static type) | | | | | |
| | | | | 3 Rs+Lsigma (Rotation type) | | | | | |
| | | | | 6 Tr (Static type) | | | | | |
| 21 | - | Stator resistance | Rs | Dependent on motor setting | Dependent on motor setting | X/A | X | O | p.144 |
| 22 | - | Leakage inductance | Lsigma | | | X/A | X | O | p.144 |
| 23 | - | Stator inductance | Ls | | | X/A | X | O | p.144 |
| 24 ⁷ | - | Rotor time constant | Tr | 25-5000(ms) | - | X/A | X | O | p.144 |
| 25 ⁷ | - | Stator inductance scale | Ls Scale | 50 ~ 150[%] | 100 | X/A | X | O | = |
| 26 ⁷ | - | Rotor time constant scale | Tr Scale | 50 ~ 150[%] | 100 | X/A | X | O | = |
| 31 ⁷ | | Regeneration inductance scale | Ls Regen Scale | 70 ~ 100[%] | 80 | X/A | X | O | = |
| 41 ⁸ | 0h1229 | User frequency1 | User Freq 1 | 0.00-Maximum frequency(Hz) | 15.00 | X/A | O | X | p.96 |
| 42 ⁸ | 0h122A | User voltage1 | User Volt 1 | 0-100(%) | 25 | X/A | O | X | p.96 |
| 43 ⁸ | 0h122B | User frequency2 | User Freq 2 | 0.00-0.00-Maximum frequency(Hz) | 30.00 | X/A | O | X | p.96 |
| 44 ⁸ | 0h122C | User voltage2 | User Volt 2 | 0-100(%) | 50 | X/A | O | X | p.96 |
| 45 ⁸ | 0h122D | User frequency3 | User Freq 3 | 0.00-Maximum frequency(Hz) | 45.00 | X/A | O | X | p.96 |
| 46 ⁸ | 0h122E | User voltage3 | User Volt 3 | 0-100(%) | 75 | X/A | O | X | p.96 |
| 47 ⁸ | 0h122F | User frequency4 | User Freq 4 | 0.00-Maximum frequency(Hz) | Maximum frequency | X/A | O | X | p.96 |

⁷ Displayed when dr.09 is set to 4(IM Sensorless)

⁸ Displayed if either bA.07 or M2.25 is set to 2 (User V/F).

| Code | Comm. Address | Name | LCD Display | Setting Range | Initial Value | Property* | V/F | SL | Ref. |
|------------------|---------------|-------------------------------|-------------|----------------------------|-------------------|-----------|-----|----|----------------------|
| 48 ⁸ | 0h1230 | User voltage4 | User Volt 4 | 0-100(%) | 100 | X/A | O | X | p.96 |
| 50 ⁹ | 0h1232 | Multi-step speed frequency1 | Step Freq-1 | 0.00-Maximum frequency(Hz) | 10.00 | O/L | O | O | p.77 |
| 51 ⁹ | 0h1233 | Multi-step speed frequency2 | Step Freq-2 | 0.00-Maximum frequency(Hz) | 20.00 | O/L | O | O | p.77 |
| 52 ⁹ | 0h1234 | Multi-step speed frequency3 | Step Freq-3 | 0.00-Maximum frequency(Hz) | 30.00 | O/L | O | O | p.77 |
| 53 ¹⁰ | 0h1235 | Multi-step speed frequency4 | Step Freq-4 | 0.00-Maximum frequency(Hz) | 40.00 | O/A | O | O | p.77 |
| 54 ¹⁰ | 0h1236 | Multi-step speed frequency5 | Step Freq-5 | 0.00-Maximum frequency(Hz) | 50.00 | O/A | O | O | p.77 |
| 55 ¹⁰ | 0h1237 | Multi-step speed frequency6 | Step Freq-6 | 0.00-Maximum frequency(Hz) | Maximum frequency | O/A | O | O | p.77 |
| 56 ¹⁰ | 0h1238 | Multi-step speed frequency7 | Step Freq-7 | 0.00-Maximum frequency(Hz) | Maximum frequency | O/A | O | O | p.77 |
| 70 | 0h1246 | Multi-step acceleration time1 | Acc Time-1 | 0.0-600.0(s) | 20.0 | O/A | O | O | p.89 |
| 71 | 0h1247 | Multi-step deceleration time1 | Dec Time-1 | 0.0-600.0(s) | 20.0 | O/A | O | O | p.89 |
| 72 ¹¹ | 0h1248 | Multi-step acceleration time2 | Acc Time-2 | 0.0-600.0(s) | 30.0 | O/A | O | O | p.89 |
| 73 ¹¹ | 0h1249 | Multi-step deceleration time2 | Dec Time-2 | 0.0-600.0(s) | 30.0 | O/A | O | O | p.89 |
| 74 ¹¹ | 0h124A | Multi-step acceleration time3 | Acc Time-3 | 0.0-600.0(s) | 40.0 | O/A | O | O | p.89 |

⁹ Displayed when an LCD keypad is in use.

¹⁰ Displayed if one of In.65-71 is set to Speed-L/M/H

¹¹ Displayed one of In.65-71 is set to Xcel-L/M/H.

Table of Functions

| Code | Comm. Address | Name | LCD Display | Setting Range | Initial Value | Property* | V/F | SL | Ref. |
|------------------|---------------|-------------------------------|-------------|---------------|---------------|-----------|-----|----|----------------------|
| 75 ¹¹ | 0h124B | Multi-step deceleration time3 | Dec Time-3 | 0.0-600.0(s) | 40.0 | O/A | O | O | p.89 |
| 76 ¹¹ | 0h124C | Multi-step acceleration time4 | Acc Time-4 | 0.0-600.0(s) | 50.0 | O/A | O | O | p.89 |
| 77 ¹¹ | 0h124D | Multi-step deceleration time4 | Dec Time-4 | 0.0-600.0(s) | 50.0 | O/A | O | O | p.89 |
| 78 ¹¹ | 0h124E | Multi-step acceleration time5 | Acc Time-5 | 0.0-600.0(s) | 40.0 | O/A | O | O | p.89 |
| 79 ¹¹ | 0h124F | Multi-step deceleration time5 | Dec Time-5 | 0.0-600.0(s) | 40.0 | O/A | O | O | p.89 |
| 80 ¹¹ | 0h1250 | Multi-step acceleration time6 | Acc Time-6 | 0.0-600.0(s) | 30.0 | O/A | O | O | p.89 |
| 81 ¹¹ | 0h1251 | Multi-step deceleration time6 | Dec Time-6 | 0.0-600.0(s) | 30.0 | O/A | O | O | p.89 |
| 82 ¹¹ | 0h1252 | Multi-step acceleration time7 | Acc Time-7 | 0.0-600.0(s) | 20.0 | O/A | O | O | p.89 |
| 83 ¹¹ | 0h1253 | Multi-step deceleration time7 | Dec Time-7 | 0.0-600.0(s) | 20.0 | O/A | O | O | p.89 |

8.4 Expanded Function group (PAR→Ad)

In the following table, the data shaded in grey will be displayed when a related code has been selected.

SL: Sensorless vector control (dr.09)

***O/X:** Write-enabled during operation, **7/L/A:** Keypad/LCD keypad/Common

| Code | Comm. Address | Name | LCD Display | Setting Range | Initial Value | Property* | V/F | SL | Ref. |
|------------------|---------------|--|-------------|--|---------------|-----------|-----|----|-----------------------|
| 00 | - | Jump Code | Jump Code | 1-99 | 24 | O/A | O | O | p.48 |
| 01 | 0h1301 | Acceleration pattern | Acc Pattern | 0 Linear | 0: Linear | X/A | O | O | p.91 |
| 02 | 0h1302 | Deceleration pattern | Dec Pattern | 1 S-curve | | X/A | O | O | p.91 |
| 03 ¹² | 0h1303 | S-curve acceleration start point gradient | Acc S Start | 1-100(%) | 40 | X/A | O | O | p.91 |
| 04 ¹² | 0h1304 | S-curve acceleration end point gradient | Acc S End | 1-100(%) | 40 | X/A | O | O | p.91 |
| 05 ¹³ | 0h1305 | S-curve deceleration start point gradient | Dec S Start | 1-100(%) | 40 | X/A | O | O | p.91 |
| 06 ¹³ | 0h1306 | S-curve deceleration end point gradient | Dec S End | 1-100(%) | 40 | X/A | O | O | p.91 |
| 07 | 0h1307 | Start Mode | Start Mode | 0 Acc 1 DC-Start | 0:Acc | X/A | O | O | p.100 |
| 08 | 0h1308 | Stop Mode | Stop Mode | 0 Dec 1 DC-Brake 2 Free-Run 4 Power Braking | 0:Dec | X/A | O | O | p.101 |
| 09 | 0h1309 | Selection of prohibited rotation direction | Run Prevent | 0 None 1 Forward Prev 2 Reverse Prev | 0:None | X/A | O | O | p.84 |

¹² Displayed when Ad. 01 is set to 1 (S-curve).

¹³ Displayed when Ad. 02 is set to 1 (S-curve).

Table of Functions

| Code | Comm. Address | Name | LCD Display | Setting Range | Initial Value | Property* | V/F | SL | Ref. | |
|------------------|---------------|--|----------------|---|-------------------|-----------|-----|----|-----------------------|-----------------------|
| 10 | 0h130A | Starting with power on | Power-on Run | 0 | No | 0:No | O/A | O | O | p.85 |
| | | | | 1 | Yes | | | | | |
| 12 ¹⁴ | 0h130C | DC braking time at startup | DC-Start Time | 0.00-60.00(s) | 0.00 | X/A | O | O | p.100 | |
| 13 | 0h130D | Amount of applied DC | DC Inj Level | 0-200(%) | 50 | X/A | O | O | p.100 | |
| 14 ¹⁵ | 0h130E | Output blocking time before DC braking | DC-Block Time | 0.00- 60.00(s) | 0.10 | X/A | O | O | p.101 | |
| 15 ¹⁵ | 0h130F | DC braking time | DC-Brake Time | 0.00- 60.00(s) | 1.00 | X/A | O | O | p.101 | |
| 16 ¹⁵ | 0h1310 | DC braking rate | DC-Brake Level | 0-200(%) | 50 | X/A | O | O | p.101 | |
| 17 ¹⁵ | 0h1311 | DC braking frequency | DC-Brake Freq | Start frequency-60Hz | 5.00 | X/A | O | O | p.101 | |
| 20 | 0h1314 | Dwell frequency on acceleration | Acc Dwell Freq | Start frequency-Maximum frequency(Hz) | 5.00 | X/A | O | O | p.133 | |
| 21 | 0h1315 | Dwell operation time on acceleration | Acc Dwell Time | 0.0-60.0(s) | 0.0 | X/A | O | O | p.133 | |
| 22 | 0h1316 | Dwell frequency on deceleration | Dec Dwell Freq | Start frequency-Maximum frequency(Hz) | 5.00 | X/A | O | O | p.133 | |
| 23 | 0h1317 | Dwell operation time on deceleration | Dec Dwell Time | 0.0-60.0(s) | 0.0 | X/A | O | O | p.133 | |
| 24 | 0h1318 | Frequency limit | Freq Limit | 0 | No | 0:No | X/A | O | O | p.104 |
| | | | | 1 | Yes | | | | | |
| 25 ¹⁶ | 0h1319 | Frequency lower limit value | Freq Limit Lo | 0.00-Upper limit frequency(Hz) | 0.50 | O/A | O | O | p.104 | |
| 26 ¹⁶ | 0h131A | Frequency upper limit value | Freq Limit Hi | Lower limit frequency-Maximum frequency(Hz) | maximum frequency | X/A | O | O | p.104 | |
| 27 | 0h131B | Frequency jump | Jump Freq | 0 | No | 0:No | X/A | O | O | p.105 |
| | | | | 1 | Yes | | | | | |

¹⁴ Displayed when Ad. 07 is set to 1 (DC-Start).

¹⁵ Displayed when Ad. 08 is set to 1 (DC-Brake).

¹⁶ Displayed when Ad. 24 is set to 1 (Yes).

| Code | Comm. Address | Name | LCD Display | Setting Range | Initial Value | Property* | V/F | SL | Ref. | |
|------------------|---------------|---------------------------------|---------------|---|---------------|-----------|-----|----|-----------------------|-----------------------|
| 28 ¹⁷ | 0h131C | Jump frequency lower limit1 | Jump Lo 1 | 0.00-Jump frequency upper limit1(Hz) | 10.00 | O/A | O | O | p.105 | |
| 29 ¹⁷ | 0h131D | Jump frequency upper limit1 | Jump Hi 1 | Jump frequency lower limit1-Maximum frequency(Hz) | 15.00 | O/A | O | O | p.105 | |
| 30 ¹⁷ | 0h131E | Jump frequency lower limit2 | Jump Lo 2 | 0.00-Jump frequency upper limit2(Hz) | 20.00 | O/A | O | O | p.105 | |
| 31 ¹⁷ | 0h131F | Jump frequency upper limit2 | Jump Hi 2 | Jump frequency lower limit2-Maximum frequency(Hz) | 25.00 | O/A | O | O | p.105 | |
| 32 ¹⁷ | 0h1320 | Jump frequency lower limit3 | Jump Lo 3 | 0.00-Jump frequency upper limit3(Hz) | 30.00 | O/A | O | O | p.105 | |
| 33 ¹⁷ | 0h1321 | Jump frequency upper limit3 | Jump Hi 3 | Jump frequency lower limit3-Maximum frequency(Hz) | 35.00 | O/A | O | O | p.105 | |
| 41 ¹⁸ | 0h1329 | Brake release current | BR Rls Curr | 0.0-180.0(%) | 50.0 | O/A | O | O | p.179 | |
| 42 ¹⁸ | 0h132A | Brake release delay time | BR Rls Dly | 0.00-10.00(s) | 1.00 | X/A | O | O | p.179 | |
| 44 ¹⁸ | 0h132C | Brake release Forward frequency | BR Rls Fwd Fr | 0.00-Maximum frequency(Hz) | 1.00 | X/A | O | O | p.179 | |
| 45 ¹⁸ | 0h132D | Brake release Reverse frequency | BR Rls Rev Fr | 0.00-Maximum frequency(Hz) | 1.00 | X/A | O | O | p.179 | |
| 46 ¹⁸ | 0h132E | Brake engage delay time | BR Eng Dly | 0.00-10.00(s) | 1.00 | X/A | O | O | p.179 | |
| 47 ¹⁸ | 0h132F | Brake engage frequency | BR Eng Fr | 0.00-Maximum frequency(Hz) | 2.00 | X/A | O | O | p.179 | |
| 50 | 0h1332 | Energy saving operation | E-Save Mode | 0 | None | 0:None | X/A | O | X | p.156 |
| | | | | 1 | Manual | | | | | |
| | | | | 2 | Auto | | | | | |
| 51 ¹⁹ | 0h1333 | Energy saving level | Energy Save | 0-30(%) | 0 | O/A | O | X | p.156 | |

¹⁷ Displayed when Ad. 27 is set to 1 (Yes).

¹⁸ Displayed if either OU.31 or OU.33 is set to 35 (BR Control).

¹⁹ Displayed if Ad.50 is not set to 0 (None).

Table of Functions

| Code | Comm. Address | Name | LCD Display | Setting Range | Initial Value | Property* | V/F | SL | Ref. | |
|------------------|---------------|---------------------------------------|-----------------|-------------------------------------|---------------|---------------------|-----|----|-----------------------|-----------------------|
| 60 | 0h133C | Acc/Dec time transition frequency | Xcel Change Fr | 0.00-Maximum frequency(Hz) | 0.00 | X/A | O | O | p.91 | |
| 61 | 0h133D | Rotation count speed gain | Load Spd Gain | 0.1~6000.0[%] | 100.0 | O/A | O | O | - | |
| 62 | 0h133E | Rotation count speed scale | Load Spd Scale | 0 | x 1 | 0: x 1 | O/A | O | O | - |
| | | | | 1 | x 0.1 | | | | | |
| | | | | 2 | x 0.01 | | | | | |
| | | | | 3 | x 0.001 | | | | | |
| | | | | 4 | x 0.0001 | | | | | |
| 63 | 0h133F | Rotation count speed unit | Load Spd Unit | 0 | Rpm | 0: rpm | O/A | O | O | - |
| | | | | 1 | mpm | | | | | |
| 64 | 0h1340 | Cooling fan control | FAN Control | 0 | During Run | 0:Durin g Run | O/A | O | O | p.169 |
| | | | | 1 | Always ON | | | | | |
| | | | | 2 | Temp Control | | | | | |
| 65 | 0h1341 | Up/down operation frequency save | U/D Save Mode | 0 | No | 0:No | O/A | O | O | p.129 |
| | | | | 1 | Yes | | | | | |
| 66 | 0h1342 | Output contact On/Off control options | On/Off Ctrl Src | 0 | None | 0:None | X/A | O | O | p.129 |
| | | | | 1 | V1 | | | | | |
| | | | | 3 | V2 | | | | | |
| | | | | 4 | I2 | | | | | |
| | | | | 6 | Pulse | | | | | |
| 67 | 0h1343 | Output contact On level | On-Ctrl Level | Output contact off level-100.00% | 90.00 | X/A | O | O | p.180 | |
| 68 | 0h1344 | Output contact Off level | Off-Ctrl Level | -100.00-output contact on level (%) | 10.00 | X/A | O | O | p.180 | |
| 70 | 0h1346 | Safe operation selection | Run En Mode | 0 | Always Enable | 0:Alway s Enable | X/A | O | O | p.131 |
| | | | | 1 | DI Dependent | | | | | |
| 71 ²⁰ | 0h1347 | Safe operation stop options | Run Dis Stop | 0 | Free-Run | 0:Free- Run | X/A | O | O | p.131 |
| | | | | 1 | Q-Stop | | | | | |
| | | | | 2 | Q-Stop Resume | | | | | |
| 72 ²⁰ | 0h1348 | Safe operation deceleration time | Q-Stop Time | 0.0-600.0(s) | 5.0 | O/A | O | O | p.131 | |

²⁰ Displayed when Ad.70 is set to 1 (DI Dependent).

| Code | Comm. Address | Name | LCD Display | Setting Range | Initial Value | Property* | V/F | SL | Ref. | |
|------------------|---------------|--|----------------|---------------------------------|----------------|------------|-----|----|-----------------------|-----------------------|
| 74 | 0h134A | Selection of regeneration evasion function for press | RegenAvd Sel | 0 | No | 0:No | X/A | O | O | p.181 |
| | | | | 1 | Yes | | | | | |
| 75 | 0h134B | Voltage level of regeneration evasion motion for press | RegenAvd Level | 200V : 300-400V | 350 | X/A | O | O | p.181 | |
| | | | | 400V : 600-800V | 700 | | | | | |
| 76 ²¹ | 0h134C | Compensation frequency limit of regeneration evasion for press | CompFreq Limit | 0.00- 10.00Hz | 1.00 | X/A | O | O | p.181 | |
| 77 ²¹ | 0h134D | Regeneration evasion for press P gain | RegenAvd Pgain | 0.0- 100.0% | 50.0 | O/A | O | O | p.181 | |
| 78 ²¹ | 0h134E | Regeneration evasion for press I gain | RegenAvd Igain | 20-30000(ms) | 500 | O/A | O | O | p.181 | |
| 79 | 0h134F | DB Unit turn on voltage level | DB Turn On Lev | 200V: Min ²² ~400[V] | 390[V] | X/A | O | O | - | |
| | | | | 400V: Min ²² ~800[V] | 780[V] | | | | | |
| 80 | 0h1350 | Fire mode selection | Fire Mode Sel | 0 | None | 0:None | X/A | O | X | p.117 |
| | | | | 1 | Fire Mode | | | | | |
| | | | | 2 | Fire Mode Test | | | | | |
| 81 ²³ | 0h1351 | Fire mode frequency | Fire Mode Freq | 0.00~60.00(Hz) | 60.00 | X/A | O | X | p.117 | |
| 82 ²³ | 0h1352 | Fire mode direction | Fire Mode Dir | 0 | Forward | 0: Forward | X/A | O | X | p.117 |
| | | | | 1 | Reverse | | | | | |
| 83 ²³ | | Fire Mode Count | Fire Mode Cnt | Can not be modified | | | | | p.117 | |

²¹ Displayed when Ad.74 is set to 1 (Yes).

²² DC voltage value (convert bA.19 AC Input voltage) + 20V (200V type) or + 40V (400V type)

²³ Displayed when Ad.80 is set to 1 (Yes).

8.5 Control Function group (PAR→Cn)

In the following table, the data shaded in grey will be displayed when a related code has been selected.

SL: Sensorless vector control (dr.09)

***O/X:** Write-enabled during operation, **7/L/A:** Keypad/LCD keypad/Common

| Code | Comm. Address | Name | LCD Display | Setting Range | | Initial Value | Property* | V/F | SL | Ref. |
|------|---------------|---|----------------|----------------|---|---------------|-----------|-----|----|-----------------------|
| 00 | - | Jump Code | Jump Code | 1-99 | | 4 | O/A | O | O | p.48 |
| 04 | 0h1404 | Carrier frequency | Carrier Freq | Heavy Duty | V/F: 1.0-15.0(kHz) ²⁴ SL: 2.0-15.0(kHz) | 3.0 | O/A | O | O | p.165 |
| | | | | Normal Duty | V/F: 1.0-5.0(kHz) ²⁵ SL: 2.0-5.0(kHz) | 2.0 | | | | p.165 |
| 05 | 0h1405 | Switching mode | PWM Mode | 0 | Normal PWM | 0:Normal PWM | X/A | O | O | p.165 |
| | | | | 1 | Lowleakage PWM | | | | | |
| 09 | 0h1409 | Initial excitation time | PreExTime | 0.00-60.00(s) | | 1.00 | X/A | X | O | p.150 |
| 10 | 0h140A | Initial excitation amount | Flux Force | 100.0-300.0(%) | | 100.0 | X/A | X | O | p.150 |
| 11 | 0h140B | Continued operation duration | Hold Time | 0.00-60.00(s) | | 0.00 | X/A | X | O | p.150 |
| 20 | 0h1414 | Sensorless 2 nd gain display setting | SL2 G View Sel | 0 | No | 0:No | O/A | X | O | p.150 |
| | | | | 1 | Yes | | | | | |

²⁴ In case of 0.4~4.0kW, the setting range is 2.0~15.0(kHz).

²⁵ In case of 0.4~4.0kW, the setting range is 2.0~5.0(kHz).

| Code | Comm. Address | Name | LCD Display | Setting Range | Initial Value | Property* | V/F | SL | Ref. |
|------------------|---------------|---|----------------|---------------|----------------------------|-----------|-----|----|-----------------------|
| 21 | 0h1415 | Sensorless speed controller proportional gain1 | ASR-SL P Gain1 | 0-5000(%) | Dependent on motor setting | O/A | X | O | p.150 |
| 22 | 0h1416 | Sensorless speed controller integral gain1 | ASR-SL I Gain1 | 10-9999(ms) | | O/A | X | O | p.150 |
| 23 ²⁶ | 0h1417 | Sensorless speed controller proportional gain2 | ASR-SL P Gain2 | 1.0-1000.0(%) | Dependent on motor setting | O/A | X | O | p.150 |
| 24 ²⁶ | 0h1418 | Sensorless speed controller integral gain2 | ASR-SL I Gain2 | 1.0-1000.0(%) | | O/A | X | O | p.150 |
| 25 ²⁶ | 0h1419 | Sensorless speed controller integral gain 0 | ASR-SL I Gain0 | 10~9999(ms) | | O/A | X | O | - |
| 26 ²⁶ | 0h141A | Flux estimator proportional gain | Flux P Gain | 10-200(%) | | O/A | X | O | p.150 |
| 27 ²⁶ | 0h141B | Flux estimator integral gain | Flux I Gain | 10-200(%) | | O/A | X | O | p.150 |
| 28 ²⁶ | 0h141C | Speed estimator proportional gain | S-Est P Gain1 | 0-32767 | | O/A | X | O | p.150 |
| 29 ²⁶ | 0h141D | Speed estimator integral gain1 | S-Est I Gain1 | 100-1000 | | O/A | X | O | p.150 |
| 30 ²⁶ | 0h141E | Speed estimator integral gain2 | S-Est I Gain2 | 100-10000 | | O/A | X | O | p.150 |
| 31 ²⁶ | 0h141F | Sensorless current controller proportional gain | ACR SL P Gain | 10-1000 | | O/A | X | O | p.150 |
| 32 ²⁶ | 0h1420 | Sensorless current controller integral gain | ACR SL I Gain | 10 -1000 | | O/A | X | O | p.150 |
| 48 | - | Current controller P gain | ACR P Gain | 0-10000 | 1200 | O/A | X | O | - |
| 49 | - | Current controller I gain | ACR I Gain | 0-10000 | 120 | O/A | X | O | - |
| 52 | 0h1434 | Torque controller output filter | Torque Out LPF | 0-2000(ms) | 0 | X/A | X | O | p.150 |
| 53 | 0h1435 | Torque limit setting options | Torque Lmt Src | 0 | 0: Keypad | X/A | X | O | p.150 |
| | | | | 1 | | | | | |

²⁶ Displayed when dr.09 is set to 4 (IM Sensorless) and Cn.20 is set to 1 (YES).

Table of Functions

| Code | Comm. Address | Name | LCD Display | Setting Range | Initial Value | Property* | V/F | SL | Ref. |
|------------------|---------------|--|----------------|------------------------------------|-----------------|-----------|-----|----|-----------------------|
| | | | | 2 V1 | -1 | | | | |
| | | | | 4 V2 | | | | | |
| | | | | 5 I2 | | | | | |
| | | | | 6 Int 485 | | | | | |
| | | | | 8 FieldBus | | | | | |
| | | | | 9 UserSeqLink | | | | | |
| | | | | 12 Pulse | | | | | |
| 54 ²⁷ | 0h1436 | Positive-direction reverse torque limit | FWD +Trq Lmt | 0.0-200.0(%) | 180 | O/A | X | O | p.150 |
| 55 ²⁷ | 0h1437 | Positive-direction regeneration torque limit | FWD -Trq Lmt | 0.0-200.0(%) | 180 | O/A | X | O | p.150 |
| 56 ²⁷ | 0h1438 | Negative-direction reverse torque limit | REV +Trq Lmt | 0.0-200.0(%) | 180 | O/A | X | O | p.150 |
| 57 ²⁷ | 0h1439 | Negative-direction regeneration torque limit | REV -Trq Lmt | 0.0-200.0(%) | 180 | O/A | X | O | p.150 |
| 62 ²⁷ | 0h143E | Speed limit Setting | Speed Lmt Src | 0 Keypad-1 | 0: Keypad -1 | X/A | X | O | - |
| | | | | 1 Keypad-2 | | | | | |
| | | | | 2 V1 | | | | | |
| | | | | 4 V2 | | | | | |
| | | | | 5 I2 | | | | | |
| | | | | 6 Int 485 | | | | | |
| | | | | 7 FieldBus | | | | | |
| | | | | 8 UserSeqLink | | | | | |
| 63 ²⁷ | 0h143F | Positive-direction speed limit | FWD Speed Lmt | 0.00~ Maximum frequency (Hz) | 60.00 | O/A | X | O | - |
| 64 ²⁷ | 0h1440 | Negative-direction speed limit | REV Speed Lmt | 0.00~ Maximum frequency (Hz) | 60.00 | O/A | X | O | - |
| 65 ²⁷ | 0h1441 | Speed limit operation gain | Speed Lmt Gain | 100~5000[%] | 500 | O/A | X | O | - |

²⁷ Displayed when dr.09 is set to 4 (IM Sensorless). This will change the initial value of the parameter at Ad.74 (Torque limit) to 150%.

| Code | Comm. Address | Name | LCD Display | Setting Range | Initial Value | Property* | V/F | SL | Ref. | |
|------------------|-----------------------------|----------------------------------|----------------|---------------|--|----------------------|-----|----|--------------|--------------|
| 70 | 0h1446 | Speed search mode selection | SS Mode | 0 | Flying Start-1 ²⁸ | 0: Flying Start-1 | X/A | O | O | <u>p.160</u> |
| | | | | 1 | Flying Start-2 | | | | | |
| 71 | 0h1447 | Speed search operation selection | Speed Search | bit | 0000- 1111 | 0000 ²⁹ | X/A | O | O | <u>p.160</u> |
| | | | | 00 | Selection of speed search on acceleration | | | | | |
| | | | | 10 | When starting on initialization after fault trip | | | | | |
| | | | | 01 | When restarting after instantaneous power interruption | | | | | |
| 00 | When starting with power on | | | | | | | | | |
| 72 ³⁰ | 0h1448 | Speed search reference current | SS Sup-Current | 80-200(%) | 150 | O/A | O | O | <u>p.160</u> | |
| 73 ³¹ | 0h1449 | Speed search proportional gain | SS P-Gain | 0-9999 | Flying Start-1 : 100 Flying Start-2 : 600 ³² | O/A | O | O | <u>p.160</u> | |

²⁸ Will not be displayed if dr.09 is set to 4 (IM Sensorless).

²⁹ The initial value 0000 will be displayed on the keypad as .

³⁰ Displayed when any of the Cn.71 code bits are set to 1 and Cn70 is set to 0 (Flying Start-1).

³¹ Displayed when any of the Cn.71 code bits are set to 1.

Table of Functions

| Code | Comm. Address | Name | LCD Display | Setting Range | Initial Value | Property* | V/F | SL | Ref. | |
|------------------|---------------|--|---------------|----------------|-----------------------|-----------|-----|----|-----------------------|-----------------------|
| 74 ³¹ | 0h144A | Speed search integral gain | SS I-Gain | 0-9999 | Flying Start-1 : 200 | O/A | O | O | p.160 | |
| | | | | | Flying Start-2 : 1000 | | | | | |
| 75 ³¹ | 0h144B | Output blocking time before speed search | SS Block Time | 0.0-60.0(s) | 1.0 | X/A | O | O | p.160 | |
| 76 ³¹ | 0h144C | Speed search Estimator gain | Spd Est Gain | 50-150(%) | 100 | O/A | O | O | - | |
| 77 | 0h144D | Energy buffering selection | KEB Select | 0 | No | 0:No | X/A | O | O | p.154 |
| | | | | 1 | KEB-1 | | | | | |
| | | | | 2 | KEB-2 | | | | | |
| 78 ³³ | 0h144E | Energy buffering start level | KEB Start Lev | 110.0-200.0(%) | 125.0 | X/A | O | O | p.154 | |
| 79 ³³ | 0h144F | Energy buffering stop level | KEB Stop Lev | Cn78~210.0(%) | 130.0 | X/A | O | O | p.154 | |
| 80 ³³ | 0h1450 | Energy buffering P gain | KEB P Gain | 0-20000 | 1000 | O/A | O | O | p.154 | |
| 81 ³³ | 0h1451 | Energy buffering I gain | KEB I Gain | 1~20000 | 500 | O/A | O | O | p.154 | |
| 82 ³³ | 0h1452 | Energy buffering Slip gain | KEB Slip Gain | 0~2000.0% | 30.0 | O/A | O | O | p.154 | |
| 83 ³³ | 0h1453 | Energy buffering acceleration time | KEB Acc Time | 0.0~600.0(s) | 10.0 | O/A | O | O | p.154 | |
| 85 ³⁴ | 0h1455 | Flux estimator proportional gain1 | Flux P Gain1 | 100-700 | 370 | O/A | X | O | p.150 | |
| 86 ³⁴ | 0h1456 | Flux estimator proportional gain2 | Flux P Gain2 | 0-100 | 0 | O/A | X | O | p.150 | |
| 87 ³⁴ | 0h1457 | Flux estimator proportional gain3 | Flux P Gain3 | 0-500 | 100 | O/A | X | O | p.150 | |
| 88 ³⁴ | 0h1458 | Flux estimator integral gain1 | Flux I Gain1 | 0-200 | 50 | O/A | X | O | p.150 | |
| 89 ³⁴ | 0h1459 | Flux estimator integral gain2 | Flux I Gain2 | 0-200 | 50 | O/A | X | O | p.150 | |

³² The initial value is 1200 when the motor-rated capacity is less than 7.5 kW

³³ Displayed when Cn.77 is not set to 0 (No).

³⁴ Displayed when Cn.20 is set to 1 (Yes).

| Code | Comm. Address | Name | LCD Display | Setting Range | Initial Value | Property* | V/F | SL | Ref. |
|------------------|---------------|--|---------------|---------------|----------------------------|-----------|-----|----|-----------------------|
| 90 ³⁴ | 0h145A | Flux estimator integral gain3 | Flux I Gain3 | 0-200 | 50 | O/A | X | O | p.150 |
| 91 ³⁴ | 0h145B | Sensorless voltage compensation1 | SL Volt Comp1 | 0-60 | Dependent on motor setting | O/A | X | O | p.150 |
| 92 ³⁴ | 0h145C | Sensorless voltage compensation2 | SL Volt Comp2 | 0-60 | | O/A | X | O | p.150 |
| 93 ³⁴ | 0h145D | Sensorless voltage compensation3 | SL Volt Comp3 | 0-60 | | O/A | X | O | p.150 |
| 94 ³⁴ | 0h145E | Sensorless field weakening start frequency | SL FW Freq | 80.0-110.0(%) | 100.0 | X/A | X | O | p.147 |
| 95 ³⁴ | 0h145F | Sensorless gain switching frequency | SL Fc Freq | 0.00-8.00(Hz) | 2.00 | X/A | X | O | p.147 |

8.6 Input Terminal Block Function group (PAR→In)

In the following table, the data shaded in grey will be displayed when a related code has been selected.

SL: Sensorless vector control (dr.09)

***O/X:** Write-enabled during operation, **7/L/A:** Keypad/LCD keypad/Common

| Code | Comm. Address | Name | LCD Display | Setting Range | Initial Value | Property* | V/F | SL | Ref. |
|------|---------------|------------------------------------|---------------|---|-------------------|----------------|-----|----|----------------------|
| 00 | - | Jump Code | Jump Code | 1-99 | 65 | O/A | O | O | p.48 |
| 01 | 0h1501 | Frequency for maximum analog input | Freq at 100% | Start frequency- Maximum frequency(Hz) | Maximum frequency | O/A | O | O | p.67 |
| 02 | 0h1502 | Torque at maximum analog input | Torque at100% | 0.0-200.0(%) | 100.0 | O/A | X | X | - |
| 05 | 0h1505 | V1 input voltage display | V1 Monitor(V) | -12.00-12.00(V) | 0.00 | -/A | O | O | p.67 |
| 06 | 0h1506 | V1 input polarity selection | V1 Polarity | 0 | Unipolar | 0: Unipolar | X/A | O | O |
| | | | | 1 | Bipolar | | | | |

Table of Functions

| Code | Comm. Address | Name | LCD Display | Setting Range | Initial Value | Property* | V/F | SL | Ref. | |
|------------------|---------------|----------------------------------|---------------|------------------------------------|---------------|-----------|-----|----|----------------------|----------------------|
| 07 | 0h1507 | Time constant of V1 input filter | V1 Filter | 0-10000(ms) | 10 | O/A | O | O | p.67 | |
| 08 | 0h1508 | V1 Minimum input voltage | V1 Volt x1 | 0.00-10.00(V) | 0.00 | O/A | O | O | p.67 | |
| 09 | 0h1509 | V1 output at Minimum voltage (%) | V1 Perc y1 | 0.00-100.00(%) | 0.00 | O/A | O | O | p.67 | |
| 10 | 0h150A | V1 Maximum input voltage | V1 Volt x2 | 0.00-12.00(V) | 10.00 | O/A | O | O | p.67 | |
| 11 | 0h150B | V1 output at Maximum voltage (%) | V1 Perc y2 | 0.00-100.00(%) | 100.00 | O/A | O | O | p.67 | |
| 12 ³⁵ | 0h150C | V1 Minimum input voltage | V1 -Volt x1' | -10.00- 0.00(V) | 0.00 | O/A | O | O | p.70 | |
| 13 ³⁵ | 0h150D | V1 output at Minimum voltage (%) | V1 -Perc y1' | -100.00-0.00(%) | 0.00 | O/A | O | O | p.70 | |
| 14 ³⁵ | 0h150E | V1 Maximum input voltage | V1 -Volt x2' | -12.00- 0.00(V) | -10.00 | O/A | O | O | p.70 | |
| 15 ³⁵ | 0h150F | V1 output at Maximum voltage (%) | V1 -Perc y2' | -100.00-0.00(%) | -100.00 | O/A | O | O | p.70 | |
| 16 | 0h1510 | V1 rotation direction change | V1 Inverting | 0 | No | 0: No | O/A | O | O | p.67 |
| | | | | 1 | Yes | | | | | |
| 17 | 0h1511 | V1 quantization level | V1 Quantizing | 0.00 ³⁶ , 0.04-10.00(%) | 0.04 | X/A | O | O | p.67 | |
| 35 ³⁷ | 0h1523 | V2 input voltage display | V2 Monitor(V) | 0.00-12.00(V) | 0.00 | -/A | O | O | p.74 | |
| 37 ³⁷ | 0h1525 | V2 input filter time constant | V2 Filter | 0-10000(ms) | 10 | O/A | O | O | p.74 | |
| 38 ³⁷ | 0h1526 | V2 Minimum input voltage | V2 Volt x1 | 0.00-10.00(V) | 0.00 | O/A | X | X | p.74 | |
| 39 ³⁷ | 0h1527 | V2 output at Minimum voltage (%) | V2 Perc y1 | 0.00-100.00(%) | 0.00 | O/A | O | O | p.74 | |

³⁵ Displayed when In.06 is set to 1 (Bipolar).

³⁶ Quantizing is not used when set to 0.

³⁷ Displayed when V is selected on the analog current/voltage input circuit selection switch (SW2).

| Code | Comm. Address | Name | LCD Display | Setting Range | | Initial Value | Property* | V/F | SL | Ref. |
|------------------|---------------|-----------------------------------|-----------------|------------------------------------|------|---------------|-----------|-----|----|-----------------------|
| 40 ³⁷ | 0h1528 | V2 Maximum input voltage | V2 Volt x2 | 0.00-10.00(V) | | 10 | O/A | X | X | p.74 |
| 41 ³⁷ | 0h1529 | V2 output at Maximum voltage (%) | V2 Perc y2 | 0.00-100.00(%) | | 100.00 | O/A | O | O | p.74 |
| 46 ³⁷ | 0h152E | V2 rotation direction change | V2 Inverting | 0 | No | 0:No | O/A | O | O | p.74 |
| | | | | 1 | Yes | | | | | |
| 47 ³⁷ | 0h152F | V2 quantization level | V2 Quantizing | 0.00 ³⁶ , 0.04-10.00(%) | | 0.04 | O/A | O | O | p.74 |
| 50 ³⁸ | 0h1532 | I2 input current display | I2 Monitor (mA) | 0-24(mA) | | 0.00 | -/A | O | O | p.72 |
| 52 ³⁸ | 0h1534 | I2 input filter time constant | I2 Filter | 0-10000(ms) | | 10 | O/A | O | O | p.72 |
| 53 ³⁸ | 0h1535 | I2 minimum input current | I2 Curr x1 | 0.00-20.00(mA) | | 4.00 | O/A | O | O | p.72 |
| 54 ³⁸ | 0h1536 | I2 output at Minimum current (%) | I2 Perc y1 | 0.00-100.00(%) | | 0.00 | O/A | O | O | p.72 |
| 55 ³⁸ | 0h1537 | I2 maximum input current | I2 Curr x2 | 0.00-24.00(mA) | | 20.00 | O/A | O | O | p.72 |
| 56 ³⁸ | 0h1538 | I2 output at Maximum current (%) | I2 Perc y2 | 0.00-100.00(%) | | 100.00 | O/A | O | O | p.72 |
| 61 ³⁸ | 0h153D | Changing rotation direction of I2 | I2 Inverting | 0 | No | 0:No | O/A | O | O | p.72 |
| | | | | 1 | Yes | | | | | |
| 62 ³⁸ | 0h153E | I2 quantization level | I2 Quantizing | 0.00 ³⁶ , 0.04-10.00(%) | | 0.04 | O/A | O | O | p.72 |
| 65 | 0h1541 | P1 terminal function setting | P1 Define | 0 | None | 1:Fx | X/A | O | O | p.80 |
| | | | | 1 | Fx | | | | | |
| 66 | 0h1542 | P2 terminal function setting | P2 Define | 2 | Rx | 2:Rx | X/A | O | O | p.80 |
| 67 | 0h1543 | P3 terminal function setting | P3 Define | 3 | RST | 5:BX | X/A | O | O | p.214 |

³⁸ Displayed when I is selected on the analog current/voltage input circuit selection switch (SW2).

Table of Functions

| Code | Comm. Address | Name | LCD Display | Setting Range | | Initial Value | Property* | V/F | SL | Ref. |
|------|---------------|------------------------------|-------------|---------------|------------------|---------------|-----------|-----|----|-----------------------|
| 68 | 0h1544 | P4 terminal function setting | P4 Define | 4 | External Trip | 3:RST | X/A | O | O | p.204 |
| 69 | 0h1545 | P5 terminal function setting | P5 Define | 5 | BX | 7:Sp-L | X/A | O | O | p.214 |
| 70 | 0h1546 | P6 terminal function setting | P6 Define | 6 | JOG | 8:Sp-M | X/A | O | O | p.126 |
| 71 | 0h1547 | P7 terminal function setting | P7 Define | 7 | Speed-L | 9:Sp-H | X/A | O | O | p.77 |
| | | | | 8 | Speed-M | | | | | p.77 |
| | | | | 9 | Speed-H | | | | | p.77 |
| | | | | 11 | XCEL-L | | | | | p.89 |
| | | | | 12 | XCEL-M | | | | | p.89 |
| | | | | 13 | RUN Enable | | | | | p.131 |
| | | | | 14 | 3-Wire | | | | | p.130 |
| | | | | 15 | 2nd Source | | | | | p.106 |
| | | | | 16 | Exchange | | | | | p.168 |
| | | | | 17 | Up | | | | | p.129 |
| | | | | 18 | Down | | | | | p.129 |
| | | | | 20 | U/D Clear | | | | | p.129 |
| | | | | 21 | Analog Hold | | | | | p.77 |
| | | | | 22 | I-Term Clear | | | | | p.136 |
| | | | | 23 | PID Openloop | | | | | p.136 |
| | | | | 24 | P Gain2 | | | | | p.136 |
| | | | | 25 | XCEL Stop | | | | | p.94 |
| | | | | 26 | 2nd Motor | | | | | p.167 |
| | | | | 34 | Pre Excite | | | | | = |
| | | | | 38 | Timer In | | | | | p.178 |
| | | | | 40 | dis Aux Ref | | | | | p.122 |
| | | | | 46 | FWD JOG | | | | | p.128 |
| | | | | 47 | REV JOG | | | | | p.128 |
| | | | | 49 | XCEL-H | | | | | p.89 |
| | | | | 50 | User Seq | | | | | p.111 |
| | | | | 51 | Fire Mode | | | | | p.117 |
| | | | | 52 | KEB-1 Select | | | | | p.154 |
| | | | | 54 | TI ³⁹ | | | | | p.74 |

³⁹ Displayed when P5 is selected on Px terminal function.(Only Standard I/O)

| Code | Comm. Address | Name | LCD Display | Setting Range | Initial Value | Property* | V/F | SL | Ref. | |
|------|---------------|---|---------------------|-----------------|-------------------------|-----------|-----|----|-----------------------|----------------------|
| 84 | 0h1554 | Multi-function input terminal On filter selection | DI Delay Sel | P7 ~ P1 | 1 1111 ⁴⁰ | O/A | O | O | p.107 | |
| | | | | 0 | | | | | | Disable(Off) |
| | | | | 1 | | | | | | Enable(On) |
| 85 | 0h1555 | Multi-function input terminal On filter | DI On Delay | 0-10000(ms) | 10 | O/A | O | O | p.107 | |
| 86 | 0h1556 | Multi-function input terminal Off filter | DI Off Delay | 0-10000(ms) | 3 | O/A | O | O | p.107 | |
| 87 | 0h1557 | Multi-function input contact selection | DI NC/NO Sel | P7 – P1 | 0 0000 ⁴¹ | X/A | O | O | p.107 | |
| | | | | 0 | | | | | | A contact (NO) |
| | | | | 1 | | | | | | B contact (NC) |
| 89 | 0h1559 | Multi-step command delay time | InCheck Time | 1-5000(ms) | 1 | X/A | O | O | p.77 | |
| 90 | 0h155A | Multi-function input terminal status | DI Status | P7 – P1 | 0 0000 ⁴¹ | -A | O | O | p.107 | |
| | | | | 0 | | | | | | release(Off) |
| | | | | 1 | | | | | | Connection (On) |
| 91 | 0h155B | Pulse input amount display | Pulse Monitor (kHz) | 0.00-50.00(kHz) | 0.00 | -A | O | O | p.74 | |
| 92 | 0h155C | TI input filter time constant | TI Filter | 0-9999(ms) | 10 | O/A | O | O | p.74 | |
| 93 | 0h155D | TI Minimum input pulse | TI Pls x1 | 0.00-32.00(kHz) | 0.00 | O/A | O | O | p.74 | |
| 94 | 0h153E | TI output at Minimum pulse (%) | TI Perc y1 | 0.00-100.00(%) | 0.00 | O/A | O | O | p.74 | |
| 95 | 0h155F | TI Maximum input pulse | TI Pls x2 | 0.00-32.00(kHz) | 32.00 | O/A | O | O | p.74 | |
| 96 | 0h1560 | TI Output at Maximum pulse (%) | TI Perc y2 | 0-100(%) | 100.00 | O/A | O | O | p.74 | |
| 97 | 0h1561 | TI rotation direction change | TI Inverting | 0 | No | 0:No | O/A | O | O | p.74 |
| | | | | 1 | Yes | | | | | |

⁴⁰ The initial value 11111 will be displayed on the keypad as 

⁴¹ The initial value 0000 will be displayed on the keypad as 

Table of Functions

| Code | Comm. Address | Name | LCD Display | Setting Range | Initial Value | Property* | V/F | SL | Ref. | |
|------|---------------|---------------------------------------|---------------|------------------------------------|---------------|-----------|-----|----|----------------------|---|
| 98 | 0h1562 | TI quantization level | TI Quantizing | 0.00 ³⁶ , 0.04-10.00(%) | 0.04 | O/A | O | O | p.74 | |
| 99 | 0h1563 | SW1(NPN/PNP) SW2(V1/V2[I2]) status | IO SW State | Bit | 00~11 | 00 | -/A | O | O | - |
| | | | | 00 | V2, NPN | | | | | |
| | | | | 01 | V2, PNP | | | | | |
| | | | | 10 | I2, NPN | | | | | |
| | | | | 11 | I2, PNP | | | | | |

8.7 Output Terminal Block Function group (PAR→OU)

In the following table, the data shaded in grey will be displayed when a related code has been selected.

SL: Sensorless vector control (dr.09)

***O/X:** Write-enabled during operation, **7/L/A:** Keypad/LCD keypad/Common

| Code | Comm. Address | Name | LCD Display | Setting Range | Initial Value | Property* | V/F | SL | Ref. | |
|------|---------------|------------------------|-------------|-------------------|----------------|-------------|-----|----|-----------------------|-----------------------|
| 00 | - | Jump Code | JumpCode | 1-99 | 30 | O/A | O | O | p.48 | |
| 01 | 0h1601 | Analog output 1 item | AO1 Mode | 0 | Frequency | 0:Frequency | O/A | O | O | p.182 |
| | | | | 1 | Output Current | | | | | |
| | | | | 2 | Output Voltage | | | | | |
| | | | | 3 | DCLink Voltage | | | | | |
| | | | | 4 | Torque | | | | | |
| | | | | 5 | Output Power | | | | | |
| | | | | 6 | Idse | | | | | |
| | | | | 7 | Iqse | | | | | |
| | | | | 8 | Target Freq | | | | | |
| | | | | 9 | Ramp Freq | | | | | |
| | | | | 10 | Speed Fdb | | | | | |
| | | | | 12 | PID Ref Value | | | | | |
| | | | | 13 | PID Fdb Value | | | | | |
| | | | | 14 | PID Output | | | | | |
| | | | | 15 | Constant | | | | | |
| 02 | 0h1602 | Analog output 1 gain | AO1 Gain | -1000.0-1000.0(%) | 100.0 | O/A | O | O | p.182 | |
| 03 | 0h1603 | Analog output 1 bias | AO1 Bias | -100.0-100.0(%) | 0.0 | O/A | O | O | p.182 | |
| 04 | 0h1604 | Analog output 1 filter | AO1 Filter | 0-10000(ms) | 5 | O/A | O | O | p.182 | |

| Code | Comm. Address | Name | LCD Display | Setting Range | Initial Value | Property* | V/F | SL | Ref. | |
|------|---------------|-----------------------------|---------------|---------------|-----------------------------------|-------------------|-----|----|--------------|--------------|
| 05 | 0h1606 | Analog constant output 1 | AO1 Const % | 0.0-100.0(%) | 0.0 | O/A | O | O | <u>p.182</u> | |
| 06 | 0h1606 | Analog output 1 monitor | AO1 Monitor | 0.0-1000.0(%) | 0.0 | -/A | O | O | <u>p.182</u> | |
| 30 | 0h161E | Fault output item | Trip Out Mode | bit | 000-111 | 010 ⁴² | O/A | O | O | <u>p.191</u> |
| | | | | 1 | Low voltage | | | | | |
| | | | | 2 | Any faults other than low voltage | | | | | |
| | | | | 3 | Automatic restart final failure | | | | | |
| 31 | 0h161F | Multi-function relay 1 item | Relay 1 | 0 | None | 29:Trip | O/A | O | O | <u>p.187</u> |
| | | | | 1 | FDT-1 | | | | | |
| | | | | 2 | FDT-2 | | | | | |
| | | | | 3 | FDT-3 | | | | | |
| | | | | 4 | FDT-4 | | | | | |
| | | | | 5 | Over Load | | | | | |
| | | | | 6 | IOL | | | | | |
| | | | | 7 | Under Load | | | | | |
| | | | | 8 | Fan Warning | | | | | |
| | | | | 9 | Stall | | | | | |
| | | | | 10 | Over Voltage | | | | | |
| | | | | 11 | Low Voltage | | | | | |
| | | | | 12 | Over Heat | | | | | |
| | | | | 13 | Lost Command | | | | | |
| | | | | 14 | Run | | | | | |
| | | | | 15 | Stop | | | | | |
| | | | | 16 | Steady | | | | | |
| 17 | Inverter Line | | | | | | | | | |
| 18 | Comm Line | | | | | | | | | |
| 19 | Speed Search | | | | | | | | | |
| 22 | Ready | | | | | | | | | |
| 28 | Timer Out | | | | | | | | | |
| 29 | Trip | | | | | | | | | |

⁴² The initial value 0010 will be displayed on the keypad as .

Table of Functions

| Code | Comm. Address | Name | LCD Display | Setting Range | Initial Value | Property* | V/F | SL | Ref. |
|------|---------------|-----------------------------|-------------|---------------------|---------------|-----------|-----|----|--------------|
| | | | | 31 DB Warn%ED | | | | | |
| | | | | 34 On/Off Control | | | | | |
| | | | | 35 BR Control | | | | | |
| | | | | 36 CAP.Exchange | | | | | |
| | | | | 37 FAN Exchange | | | | | |
| | | | | 38 Fire Mode | | | | | |
| | | | | 39 TO ⁴³ | | | | | |
| | | | | 40 KEB Operating | | | | | |
| 33 | 0h1621 | Multi-function output1 item | Q1 Define | 0 None | 14:Run | O/A | O | O | <u>p.187</u> |
| | | | | 1 FDT-1 | | | | | |
| | | | | 2 FDT-2 | | | | | |
| | | | | 3 FDT-3 | | | | | |
| | | | | 4 FDT-4 | | | | | |
| | | | | 5 Over Load | | | | | |
| | | | | 6 IOL | | | | | |
| | | | | 7 Under Load | | | | | |
| | | | | 8 Fan Warning | | | | | |
| | | | | 9 Stall | | | | | |
| | | | | 10 Over Voltage | | | | | |
| | | | | 11 Low Voltage | | | | | |
| | | | | 12 Over Heat | | | | | |
| | | | | 13 Lost Command | | | | | |
| | | | | 14 Run | | | | | |
| | | | | 15 Stop | | | | | |
| | | | | 16 Steady | | | | | |
| | | | | 17 Inverter Line | | | | | |
| | | | | 18 Comm Line | | | | | |
| | | | | 19 Speed Search | | | | | |
| | | | | 22 Ready | | | | | |
| | | | | 28 Timer Out | | | | | |
| | | | | 29 Trip | | | | | |
| | | | | 31 DB Warn%ED | | | | | |
| | | | | 34 On/Off Control | | | | | |
| | | | | 35 BR Control | | | | | |
| | | | | 36 CAP. Exchange | | | | | |
| | | | | 37 FAN Exchange | | | | | |
| | | | | 38 Fire Mode | | | | | |
| | | | | 39 TO ⁴³ | | | | | |
| | | | | 40 KEB Operating | | | | | |

⁴³ Supprted only Standard I/O

| Code | Comm. Address | Name | LCD Display | Setting Range | Initial Value | Property* | V/F | SL | Ref. | |
|------|---------------|---|----------------|----------------------------|----------------|------------------|-----|----|-----------------------|-----------------------|
| 41 | 0h1629 | Multi-function output monitor | DO Status | - | 00 | -/A | - | - | p.187 | |
| 50 | 0h1632 | Multi-function output On delay | DO On Delay | 0.00-100.00(s) | 0.00 | O/A | O | O | p.192 | |
| 51 | 0h1633 | Multi-function output Off delay | DO Off Delay | 0.00-100.00(s) | 0.00 | O/A | O | O | p.192 | |
| 52 | 0h1634 | Multi-function output contact selection | DO NC/NO Sel | Q1, Relay1 | | 00 ⁴⁴ | X/A | O | O | p.192 |
| | | | | 0 | A contact (NO) | | | | | |
| | | | | 1 | B contact (NC) | | | | | |
| 53 | 0h1635 | Fault output On delay | TripOut OnDly | 0.00-100.00(s) | 0.00 | O/A | O | O | p.191 | |
| 54 | 0h1636 | Fault output Off delay | TripOut OffDly | 0.00-100.00(s) | 0.00 | O/A | O | O | p.191 | |
| 55 | h1637 | Timer On delay | TimerOn Delay | 0.00-100.00(s) | 0.00 | O/A | O | O | p.178 | |
| 56 | 0h1638 | Timer Off delay | TimerOff Delay | 0.00-100.00(s) | 0.00 | O/A | O | O | p.178 | |
| 57 | 0h1639 | Detected frequency | FDT Frequency | 0.00-Maximum frequency(Hz) | 30.00 | O/A | O | O | p.187 | |
| 58 | 0h163A | Detected frequency band | FDT Band | 0.00-Maximum frequency(Hz) | 10.00 | O/A | O | O | p.187 | |
| 61 | 0h163D | Pulse output gain | TO Mode | 0 | Frequency | 0: Frequency | O/A | O | O | p.185 |
| | | | | 1 | Output Current | | | | | |
| | | | | 2 | Output Voltage | | | | | |
| | | | | 3 | DCLink Voltage | | | | | |
| | | | | 4 | Torque | | | | | |
| | | | | 5 | Output Power | | | | | |
| | | | | 6 | ldse | | | | | |
| | | | | 7 | lqse | | | | | |
| | | | | 8 | Target Freq | | | | | |
| | | | | 9 | Ramp Freq | | | | | |
| | | | | 10 | Speed Fdb | | | | | |

⁴⁴ The initial value 0000 will be displayed on the keypad as .

Table of Functions

| Code | Comm. Address | Name | LCD Display | Setting Range | Initial Value | Property* | V/F | SL | Ref. |
|------|---------------|--------------------------------|-------------|--------------------|---------------|-----------|-----|----|-----------------------|
| | | | | 12 PID Ref Value | | | | | |
| | | | | 13 PID Fdb Value | | | | | |
| | | | | 14 PID Output | | | | | |
| | | | | 15 Constant | | | | | |
| 62 | 0h163E | Pulse output gain | TO Gain | -1000.0-1000.0(%) | 100.0 | O/A | O | O | p.185 |
| 63 | 0h163F | Pulse output bias | TO Bias | -100.0-100.0(%) | 0.0 | O/A | O | O | p.185 |
| 64 | 0h1640 | Pulse output filter | TO Filter | 0-10000(ms) | 5 | O/A | O | O | p.185 |
| 65 | 0h1641 | Pulse output constant output 2 | TO Const % | 0.0-100.0(%) | 0.0 | O/A | O | O | p.185 |
| 66 | 0h1642 | Pulse output monitor | TO Monitor | 0.0-1000.0(%) | 0.0 | -/A | O | O | p.185 |

8.8 Communication Function group (PAR→CM)

In the following table, the data shaded in grey will be displayed when a related code has been selected.

SL: Sensorless vector control (dr.09)

***O/X:** Write-enabled during operation, **7/L/A:** Keypad/LCD keypad/Common

| Code | Comm. Address | Name | LCD Display | Setting Range | Initial Value | Property* | V/F | SL | Ref. |
|------------------|---------------|------------------------------------|--------------|--|------------------|-----------|-----|----|-----------------------|
| 00 | - | Jump Code | Jump Code | 1-99 | 20 | O/A | O | O | p.48 |
| 01 | 0h1701 | Built-in communication inverter ID | Int485 St ID | 1-250 | 1 | O/A | O | O | p.220 |
| 02 ⁴⁵ | 0h1702 | Built-in communication protocol | Int485 Proto | 0 ModBus RTU 2 LS Inv 485 | 0: ModBus RTU | O/A | O | O | p.220 |
| 03 ⁴⁵ | 0h1703 | Built-in communication speed | Int485 BaudR | 0 1200 bps 1 2400 bps 2 4800 bps 3 9600 bps | 3: 9600 bps | O/A | O | O | p.220 |

⁴⁵ Will not be displayed when P2P and MultiKPD is set.

| Code | Comm. Address | Name | LCD Display | Setting Range | Initial Value | Property* | V/F | SL | Ref. |
|------------------|---------------|--------------------------------------|----------------|---|-----------------|-----------|-----|----|--------------|
| | | | | 4 19200 bps 5 38400 bps 6 56 Kbps 7 115 Kbps ⁴⁶ | | | | | |
| 04 ⁴⁵ | 0h1704 | Built-in communication frame setting | Int485 Mode | 0 D8/PN/S1 1 D8/PN/S2 2 D8/PE/S1 3 D8/PO/S1 | 0: D8/PN/S 1 | O/A | O | O | <u>p.220</u> |
| 05 ⁴⁵ | 0h1705 | Transmission delay after reception | Resp Delay | 0-1000(ms) | 5ms | O/A | O | O | <u>p.220</u> |
| 06 ⁴⁷ | 0h1706 | Communication option S/W version | FBus S/W Ver | - | 0.00 | O/A | O | O | - |
| 07 ⁴⁷ | 0h1707 | Communication option inverter ID | FBus ID | 0-255 | 1 | O/A | O | O | - |
| 08 ⁴⁷ | 0h1708 | FIELD BUS communication speed | FBUS BaudRate | - | 12Mbps | -/A | O | O | - |
| 09 ⁴⁷ | 0h1709 | Communication option LED status | FieldBus LED | - | - | O/A | O | O | - |
| 30 | 0h171E | Number of output parameters | ParaStatus Num | 0-8 | 3 | O/A | O | O | |
| 31 ⁴⁸ | 0h171F | Output Communication address1 | Para Stauts-1 | 0000-FFFF Hex | 000A | O/A | O | O | <u>p.225</u> |
| 32 ⁴⁸ | 0h1720 | Output Communication address2 | Para Stauts-2 | 0000-FFFF Hex | 000E | O/A | O | O | <u>p.225</u> |
| 33 ⁴⁸ | 0h1721 | Output Communication address3 | Para Stauts-3 | 0000-FFFF Hex | 000F | O/A | O | O | <u>p.225</u> |

Function Table

⁴⁶ 115,200bps

⁴⁷ Displayed only when a communication option card is installed.

⁴⁸ Only the range of addresses set at COM-30 is displayed.

Table of Functions

| Code | Comm. Address | Name | LCD Display | Setting Range | Initial Value | Property* | V/F | SL | Ref. |
|------------------|---------------|-------------------------------|----------------|---------------|---------------|-----------|-----|----|-----------------------|
| 34 ⁴⁸ | 0h1722 | Output Communication address4 | Para Stauts-4 | 0000-FFFF Hex | 0000 | O/A | O | O | p.225 |
| 35 ⁴⁸ | 0h1723 | Output Communication address5 | Para Stauts-5 | 0000-FFFF Hex | 0000 | O/A | O | O | p.225 |
| 36 ⁴⁸ | 0h1724 | Output Communication address6 | Para Stauts-6 | 0000-FFFF Hex | 0000 | O/A | O | O | p.225 |
| 37 ⁴⁸ | 0h1725 | Output Communication address7 | Para Stauts-7 | 0000-FFFF Hex | 0000 | O/A | O | O | p.225 |
| 38 ⁴⁸ | 0h1726 | Output Communication address8 | Para Stauts-8 | 0000-FFFF Hex | 0000 | O/A | O | O | p.225 |
| 50 | 0h1732 | Number of input parameters | Para Ctrl Num | 0-8 | 2 | O/A | O | O | |
| 51 ⁴⁹ | 0h1733 | Input Communication address1 | Para Control-1 | 0000-FFFF Hex | 0005 | X/A | O | O | p.225 |
| 52 ⁴⁹ | 0h1734 | Input Communication address2 | Para Control-2 | 0000-FFFF Hex | 0006 | X/A | O | O | p.225 |
| 53 ⁴⁹ | 0h1735 | Input Communication address3 | Para Control-3 | 0000-FFFF Hex | 0000 | X/A | O | O | p.225 |
| 54 ⁴⁹ | 0h1736 | Input Communication address4 | Para Control-4 | 0000-FFFF Hex | 0000 | X/A | O | O | p.225 |
| 55 ⁴⁹ | 0h1737 | Input Communication address5 | Para Control-5 | 0000-FFFF Hex | 0000 | X/A | O | O | p.225 |
| 56 ⁴⁹ | 0h1738 | Input Communication address6 | Para Control-6 | 0000-FFFF Hex | 0000 | X/A | O | O | p.225 |
| 57 ⁴⁹ | 0h1739 | Input Communication address7 | Para Control-7 | 0000-FFFF Hex | 0000 | X/A | O | O | p.225 |
| 58 ⁴⁹ | 0h173A | Input Communication address8 | Para Control-8 | 0000-FFFF Hex | 0000 | X/A | O | O | p.225 |

⁴⁹ Only the range of addresses set at COM-50 is displayed.

| Code | Comm. Address | Name | LCD Display | Setting Range | | Initial Value | Property* | V/F | SL | Ref. |
|------|---------------|--------------------------------------|---------------|---------------|---------------|---------------|-----------|-----|----|-----------------------|
| | | | | | | | | | | |
| 68 | 0h1744 | Field bus data swap | FBus Swap Sel | 0 | No | 0 | X/A | O | O | p.225 |
| | | | | 1 | Yes | | | | | |
| 70 | 0h1746 | Communication multi-function input 1 | Virtual DI 1 | 0 | None | 0:None | O/A | O | O | p.244 |
| 71 | 0h1747 | Communication multi-function input 2 | Virtual DI 2 | 1 | Fx | 0:None | O/A | O | O | p.244 |
| 72 | 0h1748 | Communication multi-function input 3 | Virtual DI 3 | 2 | Rx | 0:None | O/A | O | O | p.244 |
| 73 | 0h1749 | Communication multi-function input 4 | Virtual DI 4 | 3 | RST | 0:None | O/A | O | O | p.244 |
| 74 | 0h174A | Communication multi-function input 5 | Virtual DI 5 | 4 | External Trip | 0:None | O/A | O | O | p.244 |
| 75 | 0h174B | Communication multi-function input 6 | Virtual DI 6 | 5 | BX | 0:None | O/A | O | O | p.244 |
| 76 | 0h174C | Communication multi-function input 7 | Virtual DI 7 | 6 | JOG | 0:None | O/A | O | O | p.244 |
| 77 | 0h174D | Communication multi-function input 8 | Virtual DI 8 | 7 | Speed-L | 0:None | O/A | O | O | p.244 |
| | | | | 8 | Speed-M | | | | | |
| | | | | 9 | Speed-H | | | | | |
| | | | | 11 | XCEL-L | | | | | |
| | | | | 12 | XCEL-M | | | | | |
| | | | | 13 | RUN Enable | | | | | |
| | | | | 14 | 3-Wire | | | | | |
| | | | | 15 | 2nd Source | | | | | |
| | | | | 16 | Exchange | | | | | |
| | | | | 17 | Up | | | | | |
| | | | | 18 | Down | | | | | |
| 20 | U/D Clear | | | | | | | | | |
| 21 | Analog Hold | | | | | | | | | |

Table of Functions

| Code | Comm. Address | Name | LCD Display | Setting Range | Initial Value | Property* | V/F | SL | Ref. |
|------------------|---------------|---|----------------|-----------------------|----------------|-----------|-----|----|-----------------------|
| | | | | 22 I-Term Clear | | | | | |
| | | | | 23 PID Openloop | | | | | |
| | | | | 24 P Gain2 | | | | | |
| | | | | 25 XCEL Stop | | | | | |
| | | | | 26 2nd Motor | | | | | |
| | | | | 34 Pre Excite | | | | | |
| | | | | 38 Timer In | | | | | |
| | | | | 40 dis Aux Ref | | | | | |
| | | | | 46 FWD JOG | | | | | |
| | | | | 47 REV JOG | | | | | |
| | | | | 49 XCEL-H | | | | | |
| | | | | 50 User Seq | | | | | |
| | | | | 51 Fire Mode | | | | | |
| | | | | 52 KEB-1 Select | | | | | |
| | | | | 54 TI ⁵⁰ | | | | | |
| 86 | 0h1756 | Communication multi-function input monitoring | Virt DI Status | - | 0 | X/A | O | O | p.223 |
| 90 | 0h175A | Selection of data frame communication monitor | Comm Mon Sel | 0 Int485 | 0 | O/A | O | O | - |
| | | | | 1 KeyPad | | | | | |
| 91 | 0h175B | Data frame Rev count | Rcv Frame Num | 0~65535 | 0 | O/A | O | O | - |
| 92 | 0h175C | Data frame Err count | Err Frame Num | 0~65535 | 0 | O/A | O | O | - |
| 93 | 0h175D | NAK frame count | NAK Frame Num | 0~65535 | 0 | O/A | O | O | - |
| 94 ⁵¹ | - | Communication data upload | Comm Update | 0 No | 0:No | -/A | O | O | - |
| | | | | 1 Yes | | | | | |
| 95 | 0h1760 | P2P communication selection | Int 485 Func | 0 Disable All | 0: Disable All | X/A | O | O | p.109 |
| | | | | 1 P2P Master | | | | | |
| | | | | 2 P2P Slave | | | | | |
| | | | | 3 M-KPD Ready | | | | | |
| 96 ⁵² | - | DO setting selection | P2P OUT Sel | Bit 000~111 | 0:No | O/A | O | O | p.109 |
| | | | | 001 Analog output | | | | | |

⁵⁰ Displayed when P5 is selected on Px terminal function

⁵¹ Displayed only when a communication option card is installed.

⁵² Displayed when AP.01 is set to 2 (Proc PID).

| Code | Comm. Address | Name | LCD Display | Setting Range | | Initial Value | Property* | V/F | SL | Ref. |
|------|---------------|------|-------------|---------------|-----------------------|---------------|-----------|-----|----|------|
| | | | | 010 | Multi-function relay | | | | | |
| | | | | 100 | Multi-function output | | | | | |

8.9 Application Function group (PAR→AP)

In the following table, the data shaded in grey will be displayed when a related code has been selected.

SL: Sensorless vector control (dr.09)

***O/X:** Write-enabled during operation, **7/L/A:** Keypad/LCD keypad/Common

| Code | Comm. Address | Name | LCD Display | Setting Range | | Initial Value | Property* | V/F | SL | Ref. |
|------------------|---------------|--------------------------------|----------------|-------------------|----------|---------------|-----------|-----|----|-----------------------|
| 00 | - | Jump Code | Jump Code | 1-99 | | 20 | O/A | O | O | p.48 |
| 01 | 0h1801 | Application function selection | App Mode | 0 | None | 0: None | X/A | O | O | p.136 |
| | | | | 1 | - | | | | | |
| | | | | 2 | Proc PID | | | | | |
| 02 | - | Enable user sequence | User Seq En | 0 | No | 0:No | X/A | O | O | p.111 |
| | | | | 1 | Yes | | | | | |
| 16 ⁵³ | 0h1810 | PID output monitor | PID Output | (%) | | 0.00 | -/A | O | O | p.136 |
| 17 ⁵³ | 0h1811 | PID reference monitor | PID Ref Value | (%) | | 50.00 | -/A | O | O | p.136 |
| 18 ⁵³ | 0h1812 | PID feedback monitor | PID Fdb Value | (%) | | 0.00 | -/A | O | O | p.136 |
| 19 ⁵³ | 0h1813 | PID reference setting | PID Ref Set | -100.00-100.00(%) | | 50.00 | O/A | O | O | p.136 |
| 20 ⁵³ | 0h1814 | PID reference source | PID Ref Source | 0 | Keypad | 0: Keypad | X/A | O | O | p.136 |
| | | | | 1 | V1 | | | | | |
| | | | | 3 | V2 | | | | | |
| | | | | 4 | I2 | | | | | |
| | | | | 5 | Int 485 | | | | | |
| | | | | 7 | FieldBus | | | | | |
| | | | | 8 | UserSeqL | | | | | |

Function Table

⁵³ Displayed when AP01 is set to 2 (Proc PID).

Table of Functions

| Code | Comm. Address | Name | LCD Display | Setting Range | | Initial Value | Property * | V/F | SL | Ref. |
|------------------|---------------|---|----------------|--|--------------|---------------|------------|-----|----|-----------------------|
| | | | | | ink | | | | | |
| | | | | 11 | Pulse | | | | | |
| 21 ⁵³ | 0h1815 | PID feedback source | PID F/B Source | 0 | V1 | 0:V1 | X/A | O | O | p.136 |
| | | | | 2 | V2 | | | | | |
| | | | | 3 | I2 | | | | | |
| | | | | 4 | Int 485 | | | | | |
| | | | | 6 | FieldBus | | | | | |
| | | | | 7 | UserSeqL ink | | | | | |
| | | | | 10 | Pulse | | | | | |
| 22 ⁵³ | 0h1816 | PID controller proportional gain | PID P-Gain | 0.0-1000.0(%) | | 50.0 | O/A | O | O | p.136 |
| 23 ⁵³ | 0h1817 | PID controller integral time | PID I-Time | 0.0-200.0(s) | | 10.0 | O/A | O | O | p.136 |
| 24 ⁵³ | 0h1818 | PID controller differentiation time | PID D-Time | 0-1000(ms) | | 0 | O/A | O | O | p.136 |
| 25 ⁵³ | 0h1819 | PID controller feed-forward compensation gain | PID F-Gain | 0.0-1000.0(%) | | 0.0 | O/A | O | O | p.136 |
| 26 ⁵³ | 0h181A | Proportional gain scale | P Gain Scale | 0.0-100.0(%) | | 100.0 | X/A | O | O | p.136 |
| 27 ⁵³ | 0h181B | PID output filter | PID Out LPF | 0-10000(ms) | | 0 | O/A | O | O | p.136 |
| 28 ⁵³ | 0h181C | PID Mode | PID Mode | 0 | Process PID | 0 | X/A | O | O | - |
| | | | | 1 | Normal PID | | | | | |
| 29 ⁵³ | 0h181D | PID upper limit frequency | PID Limit Hi | PID lower limit frequency-300.00(Hz) | | 60.00 | O/A | O | O | p.136 |
| 30 ⁵³ | 0h181E | PID lower limit frequency | PID Limit Lo | -300.00 -PID upper limit frequency(Hz) | | -60.00 | O/A | O | O | p.136 |
| 31 ⁵³ | 0h181F | PID output inverse | PID Out Inv | 0 | No | 0:No | X/A | O | O | p.136 |
| | | | | 1 | Yes | | | | | |
| 32 ⁵³ | 0h1820 | PID output scale | PID Out Scale | 0.1-1000.0(%) | | 100.0 | X/A | O | O | p.136 |
| 34 ⁵³ | 0h1822 | PID controller motion frequency | Pre-PID Freq | 0.00- Maximum frequency(Hz) | | 0.00 | X/A | O | O | p.136 |

| Code | Comm. Address | Name | LCD Display | Setting Range | Initial Value | Property * | V/F | SL | Ref. | |
|------------------|---------------|----------------------------------|----------------|-----------------------------------|---------------|---------------|-----|----|-----------------------|-----------------------|
| 35 ⁵³ | 0h1823 | PID controller motion level | Pre-PID Exit | 0.0-100.0(%) | 0.0 | X/A | O | O | p.136 | |
| 36 ⁵³ | 0h1824 | PID controller motion delay time | Pre-PID Delay | 0-9999(s) | 600 | O/A | O | O | p.136 | |
| 37 ⁵³ | 0h1825 | PID sleep mode delay time | PID Sleep DT | 0.0-999.9(s) | 60.0 | O/A | O | O | p.136 | |
| 38 ⁵³ | 0h1826 | PID sleep mode frequency | PID Sleep Freq | 0.00- Maximum frequency(Hz) | 0.00 | O/A | O | O | p.136 | |
| 39 ⁵³ | 0h1827 | PID wake-up level | PIDWakeUp Lev | 0-100(%) | 35 | O/A | O | O | p.136 | |
| 40 ⁵³ | 0h1828 | PID wake-up mode setting | PID WakeUp Mod | 0 | Below Level | 0:Below Level | O/A | O | O | p.136 |
| | | | | 1 | Above Level | | | | | |
| | | | | 2 | Beyond Level | | | | | |
| 42 ⁵³ | 0h182A | PID controller unit selection | PID Unit Sel | 0 | % | 0:0% | O/A | O | O | p.136 |
| | | | | 1 | Bar | | | | | |
| | | | | 2 | mBar | | | | | |
| | | | | 3 | Pa | | | | | |
| | | | | 4 | kPa | | | | | |
| | | | | 5 | Hz | | | | | |
| | | | | 6 | rpm | | | | | |
| | | | | 7 | V | | | | | |
| | | | | 8 | I | | | | | |
| | | | | 9 | kW | | | | | |
| | | | | 10 | HP | | | | | |
| | | | | 11 | °C | | | | | |
| 12 | °F | | | | | | | | | |
| 43 ⁵³ | 0h182B | PID unit gain | PID Unit Gain | 0.00- 300.00(%) | 100.00 | O/A | O | O | p.136 | |
| 44 ⁵³ | 0h182C | PID unit scale | PID Unit Scale | 0 | x100 | 2:x 1 | O/A | O | O | p.136 |
| | | | | 1 | x10 | | | | | |
| | | | | 2 | x 1 | | | | | |
| | | | | 3 | x 0.1 | | | | | |
| | | | | 4 | x 0.01 | | | | | |
| 45 ⁵³ | 0h182D | PID 2nd proportional gain | PID P2-Gain | 0.0-1000.0(%) | 100.0 | X/A | O | O | p.136 | |

8.10 Protection Function group (PAR→Pr)

In the following table, the data shaded in grey will be displayed when a related code has been selected.

SL: Sensorless vector control (dr.09)

***O/X:** Write-enabled during operation, **7/L/A:** Keypad/LCD keypad/Common

| Code | Comm. Address | Name | LCD Display | Setting Range | Initial Value | Property * | V/F | SL | Ref. | |
|------------------|---------------|---------------------------------------|----------------|---------------|-------------------|------------------|-----|----|--------------|--------------|
| 00 | - | Jump Code | Jump Code | 1-99 | 40 | O/A | O | O | <u>p.48</u> | |
| 04 | 0h1B04 | Load level setting | Load Duty | 0 | Normal Duty | 1:Heavy Duty | X/A | O | O | <u>p.198</u> |
| | | | | 1 | Heavy Duty | | | | | |
| 05 | 0h1B05 | Input/output open-phase protection | Phase Loss Chk | bi | 00-11 | 00 ⁵⁴ | X/A | O | O | <u>p.203</u> |
| | | | | 01 | Output open phase | | | | | |
| | | | | 10 | Input open phase | | | | | |
| 06 | 0h1B06 | Input voltage range during open-phase | IPOV Band | 1-100(V) | 15 | X/A | O | O | <u>p.203</u> | |
| 07 | 0h1B07 | Deceleration time at fault trip | Trip Dec Time | 0.0-600.0(s) | 3.0 | O/A | O | O | - | |
| 08 | 0h1B08 | Selection of startup on trip reset | RST Restart | 0 | No | 0:No | O/A | O | O | <u>p.164</u> |
| | | | | 1 | Yes | | | | | |
| 09 | 0h1B09 | Number of automatic restarts | Retry Number | 0-10 | 0 | O/A | O | O | <u>p.164</u> | |
| 10 ⁵⁵ | 0h1B0A | Automatic restart delay time | Retry Delay | 0.0-60.0(s) | 1.0 | O/A | O | O | <u>p.164</u> | |

⁵⁴ The initial value 0000 will be displayed on the keypad as .

⁵⁵ Displayed when Pr.09 is set higher than 0.

| Code | Comm. Address | Name | LCD Display | Setting Range | | Initial Value | Property * | V/F | SL | Ref. |
|------------------|---------------|---|----------------|---------------------------------------|-------------|---------------|------------|-----|----|-----------------------|
| 12 | 0h1B0C | Motion at speed command loss | Lost Cmd Mode | 0 | None | 0:None | O/A | O | O | p.206 |
| | | | | 1 | Free-Run | | | | | |
| | | | | 2 | Dec | | | | | |
| | | | | 3 | Hold Input | | | | | |
| | | | | 4 | Hold Output | | | | | |
| | | | | 5 | Lost Preset | | | | | |
| 13 ⁵⁶ | 0h1B0D | Time to decide speed command loss | Lost Cmd Time | 0.1-120(s) | | 1.0 | O/A | O | O | p.206 |
| 14 ⁵⁶ | 0h1B0E | Operation frequency at speed command loss | Lost Preset F | Start frequency-Maximum frequency(Hz) | | 0.00 | O/A | O | O | p.206 |
| 15 ⁵⁶ | 0h1B0F | Analog input loss decision level | AI Lost Level | 0 | Half x1 | 0:Half of x1 | O/A | O | O | p.206 |
| | | | | 1 | Below x1 | | | | | |
| 17 | 0h1B11 | Overload warning selection | OL Warn Select | 0 | No | 0:No | O/A | O | O | p.198 |
| | | | | 1 | Yes | | | | | |
| 18 | 0h1B12 | Overload alarm level | OL Warn Level | 30-180(%) | | 150 | O/A | O | O | p.198 |
| 19 | 0h1B13 | Overload warning time | OL Warn Time | 0.0-30.0(s) | | 10.0 | O/A | O | O | p.198 |
| 20 | 0h1B14 | Motion at overload fault | OL Trip Select | 0 | None | 1:Free-Run | O/A | O | O | p.198 |
| | | | | 1 | Free-Run | | | | | |
| | | | | 2 | Dec | | | | | |
| 21 | 0h1B15 | Overload fault level | OL Trip Level | 30-200(%) | | 180 | O/A | O | O | p.198 |
| 22 | 0h1B16 | Overload fault time | OL Trip Time | 0.0-60.0(s) | | 60.0 | O/A | O | O | p.198 |
| 25 | 0h1B19 | Underload warning selection | UL Warn Sel | 0 | No | 0:No | O/A | O | O | p.209 |
| | | | | 1 | Yes | | | | | |
| 26 | 0h1B1A | Underload warning time | UL Warn Time | 0.0-600.0(s) | | 10.0 | O/A | O | O | p.209 |

⁵⁶ Displayed when Pr.12 is not set to 0 (NONE).

Table of Functions

| Code | Comm. Address | Name | LCD Display | Setting Range | | Initial Value | Property * | V/F | SL | Ref. |
|------|---------------|--|----------------|---------------|--------------|---------------|------------|-----|----|-----------------------|
| 27 | 0h1B1B | Underload fault selection | UL Trip Sel | 0 | None | 0:None | O/A | O | O | p.209 |
| | | | | 1 | Free-Run | | | | | |
| | | | | 2 | Dec | | | | | |
| 28 | 0h1B1C | Underload fault time | UL Trip Time | 0.0-600.0(s) | | 30.0 | O/A | O | O | p.209 |
| 29 | 0h1B1D | Underload lower limit level | UL LF Level | 10-30(%) | | 30 | O/A | O | O | p.209 |
| 30 | 0h1B1E | Underload upper limit level | UL BF Level | 30-100(%) | | 30 | O/A | O | O | p.209 |
| 31 | 0h1B1F | No motor motion at detection | No Motor Trip | 0 | None | 0:None | O/A | O | O | p.216 |
| | | | | 1 | Free-Run | | | | | |
| 32 | 0h1B20 | No motor detection current level | No Motor Level | 1-100(%) | | 5 | O/A | O | O | p.216 |
| 33 | 0h1B21 | No motor detection delay | No Motor Time | 0.1-10.0(s) | | 3.0 | O/A | O | O | p.216 |
| 40 | 0h1B28 | Electronic thermal fault selection | ETH Trip Sel | 0 | None | 0:None | O/A | O | O | p.197 |
| | | | | 1 | Free-Run | | | | | |
| | | | | 2 | Dec | | | | | |
| 41 | 0h1B29 | Motor cooling fan type | Motor Cooling | 0 | Self-cool | 0:Self-cool | O/A | O | O | p.197 |
| | | | | 1 | Forced-cool | | | | | |
| 42 | 0h1B2A | Electronic thermal 1 minute rating | ETH 1min | 120-200(%) | | 150 | O/A | O | O | p.197 |
| 43 | 0h1B2B | Electronic thermal continuous rating | ETH Cont | 50-150(%) | | 120 | O/A | O | O | p.197 |
| 45 | 0h1B2D | BX trip mode | BX Mode | 0 | Free-Run | 0 | X/A | O | O | - |
| | | | | 1 | Dec | | | | | |
| 50 | 0h1B32 | Stall prevention motion and flux braking | Stall Prevent | bit | 0000-1111 | 0000 | X/A | O | O | p.200 |
| | | | | 0001 | Accelerating | | | | | |

| Code | Comm. Address | Name | LCD Display | Setting Range | Initial Value | Property * | V/F | SL | Ref. |
|------------------|---------------|---------------------------|--------------------|---|-------------------|------------|-----|----|--------------|
| | | | | 001 0 | At constant speed | | | | |
| | | | | 010 0 | At deceleration | | | | |
| | | | | 100 0 | FluxBraking | | | | |
| 51 | 0h1B33 | Stall frequency1 | Stall Freq 1 | Start frequency- Stall frequency2(Hz) | 60.00 | O/A | O | O | <u>p.200</u> |
| 52 | 0h1B34 | Stall level1 | Stall Level 1 | 30-250(%) | 180 | X/A | O | O | <u>p.200</u> |
| 53 | 0h1B35 | Stall frequency2 | Stall Freq 2 | Stall frequency1- Stall frequency3(Hz) | 60.00 | O/A | O | O | <u>p.200</u> |
| 54 | 0h1B36 | Stall level2 | Stall Level 2 | 30-250(%) | 180 | X/A | O | O | <u>p.200</u> |
| 55 | 0h1B37 | Stall frequency3 | Stall Freq 3 | Stall frequency2- Stall frequency4(Hz) | 60.00 | O/A | O | O | <u>p.200</u> |
| 56 | 0h1B38 | Stall level3 | Stall Level 3 | 30-250(%) | 180 | X/A | O | O | <u>p.200</u> |
| 57 | 0h1B39 | Stall frequency4 | Stall Freq 4 | Stall frequency3- Maximum frequency(Hz) | 60.00 | O/A | O | O | <u>p.200</u> |
| 58 | 0h1B3A | Stall level4 | Stall Level 4 | 30-250(%) | 180 | X/A | O | O | <u>p.200</u> |
| 59 | 0h1B3B | Flux braking gain | Flux Brake Kp | 0 ~ 150[%] | 0 | O/A | O | O | - |
| 60 | 0h1B3C | CAP diagnosis level | CAP. Diag Perc | 10 ~ 100[%] | 0 | O/A | O | O | - |
| 61 ⁵⁷ | 0h1B3D | CAP diagnosis mode | CAP. Diag | 0 | None | 0 | X/A | O | - |
| | | | | 1 | Ref Diag | | | | |
| | | | | 2 | Pre Diag | | | | |
| | | | | 3 | Init Diag | | | | |
| 62 ⁵⁷ | 0h1B3E | CAP Exchange Level | CAP Exchange Level | 50.0 ~ 95.0[%] | 0 | X/A | O | O | - |
| 63 ⁵⁷ | 0h1B3F | CAP Diag Level | CAP Diag Level | 0.0~100.0[%] | 0.0 | -/A | O | O | - |
| 66 | 0h1B42 | DB resistor warning level | DB Warn %ED | 0-30(%) | 0 | O/A | O | O | <u>p.208</u> |

Function Table

⁵⁷ The Pr.61-63 codes are displayed when the Pr.60(CAP.DiagPrec) is set to more than 0.

Table of Functions

| Code | Comm. Address | Name | LCD Display | Setting Range | Initial Value | Property * | V/F | SL | Ref. | |
|------------------|---------------|---------------------------------------|--------------------|---------------|---------------|------------|-----|----|--------------|--------------|
| 73 | 0h1B22 | Speed deviation trip | Speed Dev Trip | 0 | No | 0:No | O/A | O | O | |
| | | | | 1 | Yes | | | | | |
| 74 ⁵⁸ | 0h1B23 | Speed deviation band | Speed Dev Band | 1 ~ 20 | 5 | O/A | O | O | | |
| 75 ⁵⁸ | 0h1B24 | Speed deviation time | Speed Dev Time | 0 ~ 120 | 60 | O/A | O | O | | |
| 79 | 0h1B4F | Cooling fan fault selection | FAN Trip Mode | 0 | Trip | 1:Warning | O/A | O | O | <u>p.211</u> |
| | | | | 1 | Warning | | | | | |
| 80 | 0h1B50 | Motion selection at option trip | Opt Trip Mode | 0 | None | 1:Free-Run | O/A | O | O | <u>p.215</u> |
| | | | | 1 | Free-Run | | | | | |
| | | | | 2 | Dec | | | | | |
| 81 | 0h1B51 | Low voltage fault decision delay time | LVT Delay | 0.0-60.0(s) | 0.0 | X/A | O | O | <u>p.211</u> | |
| 82 | 0h1B52 | LV2 Selection | LV2 Enable | 0 | No | 0 | X/A | O | O | - |
| | | | | 1 | Yes | | | | | |
| 86 | 0h1B56 | Accumulated percent of fan usage | Fan Time Perc | 0.0~100.0[%] | 0.0 | -/A | O | O | - | |
| 87 | 0h1B57 | Fan exchange warning level | Fan Exchange level | 0.0~100.0[%] | 90.0 | O/A | O | O | - | |
| 88 ⁵⁹ | 0h1B58 | Fan reset time | Fan Time Rst | 0 | No | 0 | X/A | O | O | - |
| | | | | 1 | Yes | | | | | |
| 89 | 0h1B59 | CAP, FAN Status | CAP, FAN State | Bit | 00~10 | 0 | -/A | O | O | - |
| | | | | 00 | - | | | | | |
| | | | | 01 | CAP Warning | | | | | |
| | | | | 10 | FAN Warning | | | | | |
| 90 ⁵⁹ | 0h1B5A | Warning information | - | - | - | -/7 | O | O | - | |
| 91 ⁵⁹ | 0h1B5B | Fault history 1 | - | - | - | -/7 | O | O | - | |
| 92 ⁵⁹ | 0h1B5C | Fault history 2 | - | - | - | -/7 | O | O | - | |

⁵⁸ Displayed when Pr.73 is set to 1 (YES)

⁵⁹ Will not be displayed when an LCD keypad is in use.

| Code | Comm. Address | Name | LCD Display | Setting Range | Initial Value | Property * | V/F | SL | Ref. | |
|------------------|---------------|------------------------|-------------|---------------|---------------|------------|-----|----|------|---|
| 93 ⁵⁹ | 0h1B5D | Fault history 3 | - | - | - | -/7 | O | O | - | |
| 94 ⁵⁹ | 0h1B5E | Fault history 4 | - | - | - | -/7 | O | O | - | |
| 95 ⁵⁹ | 0h1B5F | Fault history 5 | - | - | - | -/7 | O | O | - | |
| 96 ⁵⁹ | 0h1B60 | Fault history deletion | - | 0 | No | 0:No | -/7 | O | O | - |
| | | | | 1 | Yes | | | | | |

8.11 2nd Motor Function group (PAR→M2)

The 2nd Motor function group will be displayed if any of In.65-71 are set to 26 (2nd MOTOR). In the following table, the data shaded in grey will be displayed when a related code has been selected.

SL: Sensorless vector control (dr.09)

***O/X:** Write-enabled during operation, **7/L/A:** Keypad/LCD keypad/Common

| Code | Comm. Address | Name | LCD Display | Setting Range | Initial Value | Property* | V/F | SL | Ref. | |
|------|---------------|-------------------|--------------|------------------|---------------|-----------|-----|----|-----------------------|-----------------------|
| 00 | - | Jump Code | Jump Code | 1-99 | 14 | O/A | O | O | p.48 | |
| 04 | 0h1C04 | Acceleration time | M2-Acc Time | 0.0-600.0(s) | 20.0 | O/A | O | O | p.167 | |
| 05 | 0h1C05 | Deceleration time | M2-Dec Time | 0.0-600.0(s) | 30.0 | O/A | O | O | p.167 | |
| 06 | 0h1C06 | Motor capacity | M2-Capacity | 0 | 0.2 kW | - | X/A | O | O | p.167 |
| | | | | 1 | 0.4 kW | | | | | |
| | | | | 2 | 0.75 kW | | | | | |
| | | | | 3 | 1.1 kW | | | | | |
| | | | | 4 | 1.5 kW | | | | | |
| | | | | 5 | 2.2 kW | | | | | |
| | | | | 6 | 3.0 kW | | | | | |
| | | | | 7 | 3.7 kW | | | | | |
| | | | | 8 | 4.0 kW | | | | | |
| | | | | 9 | 5.5 kW | | | | | |
| | | | | 10 | 7.5 kW | | | | | |
| | | | | 11 | 11.0 kW | | | | | |
| | | | | 12 | 15.0 kW | | | | | |
| | | | | 13 | 18.5 kW | | | | | |
| | | | | 14 | 22.0 kW | | | | | |
| 15 | 30.0 kW | | | | | | | | | |
| 07 | 0h1C07 | Base frequency | M2-Base Freq | 30.00-400.00(Hz) | 60.00 | X/A | O | O | p.167 | |

Table of Functions

| Code | Comm. Address | Name | LCD Display | Setting Range | Initial Value | Property* | V/F | SL | Ref. | |
|------------------|---------------|------------------------------------|----------------|-----------------------------|-----------------------------|-----------|-----|-----------------------|-----------------------|-----------------------|
| 08 | 0h1C08 | Control mode | M2-Ctrl Mode | 0 | V/F | 0:V/F | X/A | O | O | p.167 |
| | | | | 2 | Slip Compen | | | | | |
| | | | | 4 | IM Sensorless | | | | | |
| 10 | 0h1C0A | Number of motor poles | M2-Pole Num | 2-48 | | X/A | O | O | p.167 | |
| 11 | 0h1C0B | Rated slip speed | M2-Rated Slip | 0-3000(rpm) | | X/A | O | O | p.167 | |
| 12 | 0h1C0C | Motor rated current | M2-Rated Curr | 1.0-1000.0(A) | | X/A | O | O | p.167 | |
| 13 | 0h1C0D | Motor no-load current | M2-Noload Curr | 0.5-1000.0(A) | Dependent on motor settings | X/A | O | O | p.167 | |
| 14 | 0h1C0E | Motor rated voltage | M2-Rated Volt | 170-480(V) | | X/A | O | O | p.167 | |
| 15 | 0h1C0F | Motor efficiency | M2-Efficiency | 70-100(%) | | X/A | O | O | p.167 | |
| 16 | 0h1C10 | Load inertia rate | M2-Inertia Rt | 0-8 | | X/A | O | O | p.167 | |
| 17 | - | Stator resistance | M2-Rs | Dependent on motor settings | | X/A | O | O | p.167 | |
| 18 | - | Leakage inductance | M2-Lsigma | | | X/A | O | O | p.167 | |
| 19 | - | Stator inductance | M2-Ls | | | X/A | O | O | p.167 | |
| 20 ⁶⁰ | - | Rotor time constant | M2-Tr | 25-5000(ms) | X/A | O | O | p.167 | | |
| 25 | 0h1C19 | V/F pattern | M2-V/F Patt | 0 | Linear | 0: Linear | X/A | O | O | p.167 |
| | | | | 1 | Square | | | | | |
| | | | | 2 | User V/F | | | | | |
| 26 | 0h1C1A | Forward Torque boost | M2-Fwd Boost | 0.0-15.0(%) | 2.0 | X/A | O | O | p.167 | |
| 27 | 0h1C1B | Reverse Torque boost | M2-Rev Boost | 0.0-15.0(%) | | X/A | O | O | p.167 | |
| 28 | 0h1C1C | Stall prevention level | M2-Stall Lev | 30-150(%) | 150 | X/A | O | O | p.167 | |
| 29 | 0h1C1D | Electronic thermal 1 minute rating | M2-ETH 1min | 100-200(%) | 150 | X/A | O | O | p.167 | |

⁶⁰ Displayed when M2.08 is set to 4 (IM Sensorless).

| Code | Comm. Address | Name | LCD Display | Setting Range | Initial Value | Property* | V/F | SL | Ref. | |
|------|---------------|--------------------------------------|----------------|---------------|---------------|-----------|-----|----|-----------------------|---|
| 30 | 0h1C1E | Electronic thermal continuous rating | M2-ETH Cont | 50-150(%) | 100 | X/A | O | O | p.167 | |
| 40 | 0h1C28 | Rotation count speed gain | Load Spd Gain | 0~6000.0[%] | 100.0 | O/A | O | O | - | |
| 41 | 0h1C29 | Rotation count speed scale | Load Spd Scale | 0 | x 1 | 0: x 1 | O/A | O | O | - |
| | | | | 1 | x 0.1 | | | | | |
| | | | | 2 | x 0.01 | | | | | |
| | | | | 3 | x 0.001 | | | | | |
| | | | | 4 | x 0.0001 | | | | | |
| 42 | 0h1C2A | Rotation count speed unit | Load Spd Unit | 0 | Rpm | 0: rpm | O/A | O | O | - |
| | | | | 1 | mpm | | | | | |

8.12 User Sequence group (US)

This group appears when AP.02 is set to 1 (Yes) or CM.95 is set to 2 (P2P Master). The parameter cannot be changed while the user sequence is running.

SL: Sensorless vector control function (dr.09)

***O/X:** Write-enabled during operation, **7/L/A:** keypad/LCD keypad/common

| Code | Comm. Address | Name | LCD Display | Setting Range | Initial Value | Property* | V/F | SL | Ref. | |
|------|---------------|-----------------------------------|---------------|---------------|----------------|-----------|-----|----|-----------------------|-----------------------|
| 00 | - | Jump code | Jump Code | 1-99 | 31 | O/A | O | O | p.48 | |
| 01 | 0h1D01 | User sequence operation command | User Seq Con | 0 | Stop | 0:Stop | X/A | O | O | p.111 |
| | | | | 1 | Run | | | | | |
| | | | | 2 | Digital In Run | | | | | |
| 02 | 0h1D02 | User sequence operation loop time | US Loop Time | 0 | 0.01s | 1:0.02s | X/A | O | O | p.111 |
| | | | | 1 | 0.02s | | | | | |
| | | | | 2 | 0.05s | | | | | |
| | | | | 3 | 0.1s | | | | | |
| | | | | 4 | 0.5s | | | | | |
| | | | | 5 | 1s | | | | | |
| 11 | 0h1D0B | Output address link1 | Link UserOut1 | 0-0xFFFF | 0 | X/A | O | O | p.111 | |
| 12 | 0h1D0C | Output address link2 | Link UserOut2 | 0-0xFFFF | 0 | X/A | O | O | p.111 | |
| 13 | 0h1D0D | Output address link3 | Link UserOut3 | 0-0xFFFF | 0 | X/A | O | O | p.111 | |

Table of Functions

| Code | Comm. Address | Name | LCD Display | Setting Range | Initial Value | Property* | V/F | SL | Ref. |
|------|---------------|-------------------------|----------------|---------------|---------------|-----------|-----|----|-----------------------|
| 14 | 0h1D0E | Output address link4 | Link UserOut4 | 0-0xFFFF | 0 | X/A | O | O | p.111 |
| 15 | 0h1D0F | Output address link5 | Link UserOut5 | 0-0xFFFF | 0 | X/A | O | O | p.111 |
| 16 | 0h1D10 | Output address link6 | Link UserOut6 | 0-0xFFFF | 0 | X/A | O | O | p.111 |
| 17 | 0h1D11 | Output address link7 | Link UserOut7 | 0-0xFFFF | 0 | X/A | O | O | p.111 |
| 18 | 0h1D12 | Output address link8 | Link UserOut8 | 0-0xFFFF | 0 | X/A | O | O | p.111 |
| 19 | 0h1D13 | Output address link9 | Link UserOut9 | 0-0xFFFF | 0 | X/A | O | O | p.111 |
| 20 | 0h1D14 | Output address link10 | Link UserOut10 | 0-0xFFFF | 0 | X/A | O | O | p.111 |
| 21 | 0h1D15 | Output address link11 | Link UserOut11 | 0-0xFFFF | 0 | X/A | O | O | p.111 |
| 22 | 0h1D16 | Output address link12 | Link UserOut12 | 0-0xFFFF | 0 | X/A | O | O | p.111 |
| 23 | 0h1D17 | Output address link13 | Link UserOut13 | 0-0xFFFF | 0 | X/A | O | O | p.111 |
| 24 | 0h1D18 | Output address link14 | Link UserOut14 | 0-0xFFFF | 0 | X/A | O | O | p.111 |
| 25 | 0h1D19 | Output address link15 | Link UserOut15 | 0-0xFFFF | 0 | X/A | O | O | p.111 |
| 26 | 0h1D1A | Output address link16 | Link UserOut16 | 0-0xFFFF | 0 | X/A | O | O | p.111 |
| 27 | 0h1D1B | Output address link17 | Link UserOut17 | 0-0xFFFF | 0 | X/A | O | O | p.111 |
| 28 | 0h1D1C | Output address link18 | Link UserOut18 | 0-0xFFFF | 0 | X/A | O | O | p.111 |
| 31 | 0h1D1F | Input constant setting1 | Void Para1 | -9999-9999 | 0 | X/A | O | O | p.111 |
| 32 | 0h1D20 | Input constant setting2 | Void Para2 | -9999-9999 | 0 | X/A | O | O | p.111 |
| 33 | 0h1D21 | Input constant setting3 | Void Para3 | -9999-9999 | 0 | X/A | O | O | p.111 |
| 34 | 0h1D22 | Input constant setting4 | Void Para4 | -9999-9999 | 0 | X/A | O | O | p.111 |
| 35 | 0h1D23 | Input constant setting5 | Void Para5 | -9999-9999 | 0 | X/A | O | O | p.111 |
| 36 | 0h1D24 | Input constant setting6 | Void Para6 | -9999-9999 | 0 | X/A | O | O | p.111 |
| 37 | 0h1D25 | Input constant | Void Para7 | -9999-9999 | 0 | X/A | O | O | p.111 |

| Code | Comm. Address | Name | LCD Display | Setting Range | Initial Value | Property* | V/F | SL | Ref. |
|------|---------------|--------------------------|-------------|---------------|---------------|-----------|-----|----|-----------------------|
| | | setting7 | | | | | | | |
| 38 | 0h1D26 | Input constant setting8 | Void Para8 | -9999-9999 | 0 | X/A | O | O | p.111 |
| 39 | 0h1D27 | Input constant setting9 | Void Para9 | -9999-9999 | 0 | X/A | O | O | p.111 |
| 40 | 0h1D28 | Input constant setting10 | Void Para10 | -9999-9999 | 0 | X/A | O | O | p.111 |
| 41 | 0h1D29 | Input constant setting11 | Void Para11 | -9999-9999 | 0 | X/A | O | O | p.111 |
| 42 | 0h1D2A | Input constant setting12 | Void Para12 | -9999-9999 | 0 | X/A | O | O | p.111 |
| 43 | 0h1D2B | Input constant setting13 | Void Para13 | -9999-9999 | 0 | X/A | O | O | p.111 |
| 44 | 0h1D2C | Input constant setting14 | Void Para14 | -9999-9999 | 0 | X/A | O | O | p.111 |
| 45 | 0h1D2D | Input constant setting15 | Void Para15 | -9999-9999 | 0 | X/A | O | O | p.111 |
| 46 | 0h1D2E | Input constant setting16 | Void Para16 | -9999-9999 | 0 | X/A | O | O | p.111 |
| 47 | 0h1D2F | Input constant setting17 | Void Para17 | -9999-9999 | 0 | X/A | O | O | p.111 |
| 48 | 0h1D30 | Input constant setting18 | Void Para18 | -9999-9999 | 0 | X/A | O | O | p.111 |
| 49 | 0h1D31 | Input constant setting19 | Void Para19 | -9999-9999 | 0 | X/A | O | O | p.111 |
| 50 | 0h1D32 | Input constant setting20 | Void Para20 | -9999-9999 | 0 | X/A | O | O | p.111 |
| 51 | 0h1D33 | Input constant setting21 | Void Para21 | -9999-9999 | 0 | X/A | O | O | p.111 |
| 52 | 0h1D34 | Input constant setting22 | Void Para22 | -9999-9999 | 0 | X/A | O | O | p.111 |
| 53 | 0h1D35 | Input constant setting23 | Void Para23 | -9999-9999 | 0 | X/A | O | O | p.111 |
| 54 | 0h1D36 | Input constant setting24 | Void Para24 | -9999-9999 | 0 | X/A | O | O | p.111 |
| 55 | 0h1D37 | Input constant setting25 | Void Para25 | -9999-9999 | 0 | X/A | O | O | p.111 |
| 56 | 0h1D38 | Input constant setting26 | Void Para26 | -9999-9999 | 0 | X/A | O | O | p.111 |
| 57 | 0h1D39 | Input constant setting27 | Void Para27 | -9999-9999 | 0 | X/A | O | O | p.111 |
| 58 | 0h1D3A | Input constant | Void Para28 | -9999-9999 | 0 | X/A | O | O | p.111 |

Table of Functions

| Code | Comm. Address | Name | LCD Display | Setting Range | Initial Value | Property* | V/F | SL | Ref. |
|------|---------------|--------------------------|-------------|----------------|---------------|-----------|-----|----|-----------------------|
| | | setting28 | | | | | | | |
| 59 | 0h1D3B | Input constant setting29 | Void Para29 | -9999-9999 | 0 | X/A | O | O | p.111 |
| 60 | 0h1D3C | Input constant setting30 | Void Para30 | -9999-9999 | 0 | X/A | O | O | p.111 |
| 80 | 0h1D50S | Analog input 1 | P2P In V1 | 0-12,000 | | -/A | O | O | p.111 |
| 81 | 0h1D51 | Analog input2 | P2P In I2 | -12,000-12,000 | | -/A | O | O | p.111 |
| 82 | 0h1D52 | Digital input | P2P In DI | 0-0x7F | | -/A | O | O | p.111 |
| 85 | 0h1D55 | Analog output | P2P OutAO1 | 0-10,000 | 0 | X/A | O | O | p.111 |
| 88 | 0h1D58 | Digital output | P2P OutDO | 0-0x03 | 0 | X/A | O | O | p.111 |

8.13 User Sequence Function group(UF)

This group appears when AP.02 is set to 1 (Yes) or CM.95 is set to 2 (P2P Master). The parameter cannot be changed while the user sequence is running.

SL: Sensorless vector control function (dr.09)

***O/X:** Write-enabled during operation, **7/L/A:** keypad/LCD keypad/common

| Code | Comm. Address | Name | LCD Display | Setting Range | Initial Value | Property* | V/F | SL | Ref. | |
|------|---------------|----------------|-------------|---------------|---------------|-----------|-----|----|----------------------|-----------------------|
| 00 | - | Jump code | Jump Code | 1-99 | 41 | O/A | O | O | p.48 | |
| 01 | 0h1E01 | User function1 | User Func1 | 0 | NOP | 0:NOP | X/A | O | O | p.111 |
| | | | | 1 | ADD | | | | | |
| | | | | 2 | SUB | | | | | |
| | | | | 3 | ADDSUB | | | | | |
| | | | | 4 | MIN | | | | | |
| | | | | 5 | MAX | | | | | |
| | | | | 6 | ABS | | | | | |
| | | | | 7 | NEGATE | | | | | |
| | | | | 8 | MPYDIV | | | | | |
| | | | | 9 | REMAINDER | | | | | |
| | | | | 10 | COMPARE-GT | | | | | |
| | | | | 11 | COMPARE-GEQ | | | | | |
| | | | | 12 | COMPARE-EQUAL | | | | | |

| Code | Comm. Address | Name | LCD Display | Setting Range | Initial Value | Property* | V/F | SL | Ref. | |
|------|---------------|------------------------|---------------|-------------------|---------------|-----------|-----|----|--------------|--------------|
| | | | | 13 COMPARE-NEQUAL | | | | | | |
| | | | | 14 TIMER | | | | | | |
| | | | | 15 LIMIT | | | | | | |
| | | | | 16 AND | | | | | | |
| | | | | 17 OR | | | | | | |
| | | | | 18 XOR | | | | | | |
| | | | | 19 ANDOR | | | | | | |
| | | | | 20 SWITCH | | | | | | |
| | | | | 21 BITTEST | | | | | | |
| | | | | 22 BITSET | | | | | | |
| | | | | 23 BITCLEAR | | | | | | |
| | | | | 24 LOWPASSFILTER | | | | | | |
| | | | | 25 PI_CONTORL | | | | | | |
| | | | | 26 PI_PROCESS | | | | | | |
| | | | | 27 UPCOUNT | | | | | | |
| | | | | 28 DOWNCOUNT | | | | | | |
| 02 | 0h1E02 | User function input1-A | User Input1-A | 0-0xFFFF | 0 | X/A | O | O | <u>p.111</u> | |
| 03 | 0h1E03 | User function input1-B | User Input1-B | 0-0xFFFF | 0 | X/A | O | O | <u>p.111</u> | |
| 04 | 0h1E04 | User function input1-C | User Input1-C | 0-0xFFFF | 0 | X/A | O | O | <u>p.111</u> | |
| 05 | 0h1E05 | User function output1 | User Output1 | -32767-32767 | 0 | -/A | O | O | <u>p.111</u> | |
| 06 | 0h1E06 | User function 2 | User Func2 | 0 | NOP | 0:NOP | X/A | O | O | <u>p.111</u> |
| | | | | 1 | ADD | | | | | |
| | | | | 2 | SUB | | | | | |
| | | | | 3 | ADDSUB | | | | | |
| | | | | 4 | MIN | | | | | |
| | | | | 5 | MAX | | | | | |
| | | | | 6 | ABS | | | | | |
| | | | | 7 | NEGATE | | | | | |
| | | | | 8 | MPYDIV | | | | | |
| | | | | 9 | REMAINDER | | | | | |
| | | | | 10 | COMPARE-GT | | | | | |
| 11 | COMPARE-GEQ | | | | | | | | | |

Function Table

Table of Functions

| Code | Comm. Address | Name | LCD Display | Setting Range | Initial Value | Property* | V/F | SL | Ref. | |
|------|---------------|------------------------|---------------|-------------------|---------------|-----------|-----|----|--------------|--------------|
| | | | | 12 COMPARE-EQUAL | | | | | | |
| | | | | 13 COMPARE-NEQUAL | | | | | | |
| | | | | 14 TIMER | | | | | | |
| | | | | 15 LIMIT | | | | | | |
| | | | | 16 AND | | | | | | |
| | | | | 17 OR | | | | | | |
| | | | | 18 XOR | | | | | | |
| | | | | 19 ANDOR | | | | | | |
| | | | | 20 SWITCH | | | | | | |
| | | | | 21 BITTEST | | | | | | |
| | | | | 22 BITSET | | | | | | |
| | | | | 23 BITCLEAR | | | | | | |
| | | | | 24 LOWPASSFILTER | | | | | | |
| | | | | 25 PI_CONTORL | | | | | | |
| | | | | 26 PI_PROCESS | | | | | | |
| | | | | 27 UPCOUNT | | | | | | |
| | | | | 28 DOWNCOUNT | | | | | | |
| 07 | 0h1E07 | User function input2-A | User Input2-A | 0-0xFFFF | 0 | X/A | O | O | <u>p.111</u> | |
| 08 | 0h1E08 | User function input2-B | User Input2-B | 0-0xFFFF | 0 | X/A | O | O | <u>p.111</u> | |
| 09 | 0h1E09 | User function input2-C | User Input2-C | 0-0xFFFF | 0 | X/A | O | O | <u>p.111</u> | |
| 10 | 0h1E0A | User function output2 | User Output2 | -32767-32767 | 0 | -/A | O | O | <u>p.111</u> | |
| 11 | 0h1E0B | User function3 | User Func3 | 0 | NOP | 0:NOP | X/A | O | O | <u>p.111</u> |
| | | | | 1 | ADD | | | | | |
| | | | | 2 | SUB | | | | | |
| | | | | 3 | ADDSUB | | | | | |
| | | | | 4 | MIN | | | | | |
| | | | | 5 | MAX | | | | | |
| | | | | 6 | ABS | | | | | |
| | | | | 7 | NEGATE | | | | | |
| | | | | 8 | MPYDIV | | | | | |
| | | | | 9 | REMAINDER | | | | | |
| | | | | 10 | COMPARE-GT | | | | | |

| Code | Comm. Address | Name | LCD Display | Setting Range | Initial Value | Property* | V/F | SL | Ref. |
|------|---------------|------------------------|---------------|-------------------|---------------|-----------|-----|----|--------------|
| | | | | 11 COMPARE-GEQ | | | | | |
| | | | | 12 COMPARE-EQUAL | | | | | |
| | | | | 13 COMPARE-NEQUAL | | | | | |
| | | | | 14 TIMER | | | | | |
| | | | | 15 LIMIT | | | | | |
| | | | | 16 AND | | | | | |
| | | | | 17 OR | | | | | |
| | | | | 18 XOR | | | | | |
| | | | | 19 ANDOR | | | | | |
| | | | | 20 SWITCH | | | | | |
| | | | | 21 BITTEST | | | | | |
| | | | | 22 BITSET | | | | | |
| | | | | 23 BITCLEAR | | | | | |
| | | | | 24 LOWPASSFILTER | | | | | |
| | | | | 25 PI_CONTORL | | | | | |
| | | | | 26 PI_PROCESS | | | | | |
| | | | | 27 UPCOUNT | | | | | |
| | | | | 28 DOWNCOUNT | | | | | |
| 12 | 0h1E0C | User function input3-A | User Input3-A | 0-0xFFFF | 0 | X/A | O | O | <u>p.111</u> |
| 13 | 0h1E0D | User function input3-B | User Input3-B | 0-0xFFFF | 0 | X/A | O | O | <u>p.111</u> |
| 14 | 0h1E0E | User function input3-C | User Input3-C | 0-0xFFFF | 0 | X/A | O | O | <u>p.111</u> |
| 15 | 0h1E0F | User function output3 | User Output3 | -32767-32767 | 0 | -/A | O | O | <u>p.111</u> |
| 16 | 0h1E10 | User function4 | User Func4 | 0 NOP | 0:NOP | X/A | O | O | <u>p.111</u> |
| | | | | 1 ADD | | | | | |
| | | | | 2 SUB | | | | | |
| | | | | 3 ADDSUB | | | | | |
| | | | | 4 MIN | | | | | |
| | | | | 5 MAX | | | | | |
| | | | | 6 ABS | | | | | |
| | | | | 7 NEGATE | | | | | |
| | | | | 8 MPYDIV | | | | | |

Function Table

Table of Functions

| Code | Comm. Address | Name | LCD Display | Setting Range | Initial Value | Property* | V/F | SL | Ref. | |
|------|---------------|------------------------|---------------|---------------|----------------|-----------|-----|----|-----------------------|-----------------------|
| | | | | 9 | REMAINDER | | | | | |
| | | | | 10 | COMPARE-GT | | | | | |
| | | | | 11 | COMPARE-GEQ | | | | | |
| | | | | 12 | COMPARE-EQUAL | | | | | |
| | | | | 13 | COMPARE-NEQUAL | | | | | |
| | | | | 14 | TIMER | | | | | |
| | | | | 15 | LIMIT | | | | | |
| | | | | 16 | AND | | | | | |
| | | | | 17 | OR | | | | | |
| | | | | 18 | XOR | | | | | |
| | | | | 19 | ANDOR | | | | | |
| | | | | 20 | SWITCH | | | | | |
| | | | | 21 | BITTEST | | | | | |
| | | | | 22 | BITSET | | | | | |
| | | | | 23 | BITCLEAR | | | | | |
| | | | | 24 | LOWPASSFILTER | | | | | |
| | | | | 25 | PI_CONTORL | | | | | |
| | | | | 26 | PI_PROCESS | | | | | |
| | | | | 27 | UPCOUNT | | | | | |
| | | | | 28 | DOWNCOUNT | | | | | |
| 17 | 0h1E11 | User function input4-A | User Input4-A | 0-0xFFFF | 0 | X/A | O | O | p.111 | |
| 18 | 0h1E12 | User function input4-B | User Input4-B | 0-0xFFFF | 0 | X/A | O | O | p.111 | |
| 19 | 0h1E13 | User function input4-C | User Input4-C | 0-0xFFFF | 0 | X/A | O | O | p.111 | |
| 20 | 0h1E14 | User function output4 | User Output4 | -32767-32767 | 0 | -/A | O | O | p.111 | |
| 21 | 0h1E15 | User function5 | User Func5 | 0 | NOP | 0:NOP | X/A | O | O | p.111 |
| 1 | | | | ADD | | | | | | |
| 2 | | | | SUB | | | | | | |
| 3 | | | | ADDSUB | | | | | | |
| 4 | | | | MIN | | | | | | |
| 5 | | | | MAX | | | | | | |
| 6 | | | | ABS | | | | | | |
| 7 | | | | NEGATE | | | | | | |

| Code | Comm. Address | Name | LCD Display | Setting Range | Initial Value | Property* | V/F | SL | Ref. |
|------|---------------|------------------------|---------------|-------------------|---------------|-----------|-----|----|--------------|
| | | | | 8 MPYDIV | | | | | |
| | | | | 9 REMAINDER | | | | | |
| | | | | 10 COMPARE-GT | | | | | |
| | | | | 11 COMPARE-GEQ | | | | | |
| | | | | 12 COMPARE-EQUAL | | | | | |
| | | | | 13 COMPARE-NEQUAL | | | | | |
| | | | | 14 TIMER | | | | | |
| | | | | 15 LIMIT | | | | | |
| | | | | 16 AND | | | | | |
| | | | | 17 OR | | | | | |
| | | | | 18 XOR | | | | | |
| | | | | 19 ANDOR | | | | | |
| | | | | 20 SWITCH | | | | | |
| | | | | 21 BITTEST | | | | | |
| | | | | 22 BITSET | | | | | |
| | | | | 23 BITCLEAR | | | | | |
| | | | | 24 LOWPASSFILTER | | | | | |
| | | | | 25 PI_CONTORL | | | | | |
| | | | | 26 PI_PROCESS | | | | | |
| | | | | 27 UPCOUNT | | | | | |
| | | | | 28 DOWNCOUNT | | | | | |
| 22 | 0h1E16 | User function input5-A | User Input5-A | 0-0xFFFF | 0 | X/A | O | O | <u>p.111</u> |
| 23 | 0h1E17 | User function input5-B | User Input5-B | 0-0xFFFF | 0 | X/A | O | O | <u>p.111</u> |
| 24 | 0h1E18 | User function input5-C | User Input5-C | 0-0xFFFF | 0 | X/A | O | O | <u>p.111</u> |
| 25 | 0h1E19 | User function output5 | User Output5 | -32767-32767 | 0 | -/A | O | O | <u>p.111</u> |
| 26 | 0h1E1A | User function6 | User Func6 | 0 NOP | 0:NOP | X/A | O | O | <u>p.111</u> |
| | | | | 1 ADD | | | | | |
| | | | | 2 SUB | | | | | |
| | | | | 3 ADDSUB | | | | | |
| | | | | 4 MIN | | | | | |
| | | | | 5 MAX | | | | | |

Function Table

Table of Functions

| Code | Comm. Address | Name | LCD Display | Setting Range | Initial Value | Property* | V/F | SL | Ref. |
|------|---------------|------------------------|---------------|-------------------|---------------|-----------|-----|----|--------------|
| | | | | 6 ABS | | | | | |
| | | | | 7 NEGATE | | | | | |
| | | | | 8 MPYDIV | | | | | |
| | | | | 9 REMAINDER | | | | | |
| | | | | 10 COMPARE-GT | | | | | |
| | | | | 11 COMPARE-GEQ | | | | | |
| | | | | 12 COMPARE-EQUAL | | | | | |
| | | | | 13 COMPARE-NEQUAL | | | | | |
| | | | | 14 TIMER | | | | | |
| | | | | 15 LIMIT | | | | | |
| | | | | 16 AND | | | | | |
| | | | | 17 OR | | | | | |
| | | | | 18 XOR | | | | | |
| | | | | 19 ANDOR | | | | | |
| | | | | 20 SWITCH | | | | | |
| | | | | 21 BITTEST | | | | | |
| | | | | 22 BITSET | | | | | |
| | | | | 23 BITCLEAR | | | | | |
| | | | | 24 LOWPASSFILTER | | | | | |
| | | | | 25 PI_CONTORL | | | | | |
| | | | | 26 PI_PROCESS | | | | | |
| | | | | 27 UPCOUNT | | | | | |
| | | | | 28 DOWNCOUNT | | | | | |
| 27 | 0h1E1B | User function input6-A | User Input6-A | 0-0xFFFF | 0 | X/A | O | O | <u>p.111</u> |
| 28 | 0h1E1C | User function input6-B | User Input6-B | 0-0xFFFF | 0 | X/A | O | O | <u>p.111</u> |
| 29 | 0h1E1D | User function input6-C | User Input6-C | 0-0xFFFF | 0 | X/A | O | O | <u>p.111</u> |
| 30 | 0h1E1E | User function output6 | User Output6 | -32767-32767 | 0 | -/A | O | O | <u>p.111</u> |
| 31 | 0h1E1F | User function7 | User Func7 | 0 NOP | 0:NOP | X/A | O | O | <u>p.111</u> |
| | | | | 1 ADD | | | | | |
| | | | | 2 SUB | | | | | |

| Code | Comm. Address | Name | LCD Display | Setting Range | Initial Value | Property* | V/F | SL | Ref. |
|------|---------------|------------------------|---------------|------------------|---------------|-----------|-----|----|--------------|
| | | | | 3 ADDSUB | | | | | |
| | | | | 4 MIN | | | | | |
| | | | | 5 MAX | | | | | |
| | | | | 6 ABS | | | | | |
| | | | | 7 NEGATE | | | | | |
| | | | | 8 MPYDIV | | | | | |
| | | | | 9 REMAINDER | | | | | |
| | | | | 10 COMPARE-GT | | | | | |
| | | | | 11 COMPARE-GEQ | | | | | |
| | | | | 12 COMPARE-EQUAL | | | | | |
| | | | | 13 COMPARE- | | | | | |
| | | | | 14 TIMER | | | | | |
| | | | | 15 LIMIT | | | | | |
| | | | | 16 AND | | | | | |
| | | | | 17 OR | | | | | |
| | | | | 18 XOR | | | | | |
| | | | | 19 ANDOR | | | | | |
| | | | | 20 SWITCH | | | | | |
| | | | | 21 BITTEST | | | | | |
| | | | | 22 BITSET | | | | | |
| | | | | 23 BITCLEAR | | | | | |
| | | | | 24 LOWPASSFILTER | | | | | |
| | | | | 25 PI_CONTORL | | | | | |
| | | | | 26 PI_PROCESS | | | | | |
| | | | | 27 UPCOUNT | | | | | |
| | | | | 28 DOWNCOUNT | | | | | |
| 32 | 0h1E20 | User function input7-A | User Input7-A | 0-0xFFFF | 0 | X/A | O | O | <u>p.111</u> |
| 33 | 0h1E21 | User function input7-B | User Input7-B | 0-0xFFFF | 0 | X/A | O | O | <u>p.111</u> |
| 34 | 0h1E22 | User function input7-C | User Input7-C | 0-0xFFFF | 0 | X/A | O | O | <u>p.111</u> |
| 35 | 0h1E23 | User function output7 | User Output7 | -32767-32767 | 0 | -/A | O | O | <u>p.111</u> |
| 36 | 0h1E24 | User function8 | User | 0 NOP | 0:NOP | X/A | O | O | <u>p.111</u> |

Table of Functions

| Code | Comm. Address | Name | LCD Display | Setting Range | Initial Value | Property* | V/F | SL | Ref. |
|------|---------------|------------------------|---------------|---------------|----------------|-----------|-----|----|--------------|
| | | | Func8 | 1 | ADD | | | | |
| | | | | 2 | SUB | | | | |
| | | | | 3 | ADDSUB | | | | |
| | | | | 4 | MIN | | | | |
| | | | | 5 | MAX | | | | |
| | | | | 6 | ABS | | | | |
| | | | | 7 | NEGATE | | | | |
| | | | | 8 | MPYDIV | | | | |
| | | | | 9 | REMAINDER | | | | |
| | | | | 10 | COMPARE-GT | | | | |
| | | | | 11 | COMPARE-GEQ | | | | |
| | | | | 12 | COMPARE-EQUAL | | | | |
| | | | | 13 | COMPARE-NEQUAL | | | | |
| | | | | 14 | TIMER | | | | |
| | | | | 15 | LIMIT | | | | |
| | | | | 16 | AND | | | | |
| | | | | 17 | OR | | | | |
| | | | | 18 | XOR | | | | |
| | | | | 19 | ANDOR | | | | |
| | | | | 20 | SWITCH | | | | |
| | | | | 21 | BITTEST | | | | |
| | | | | 22 | BITSET | | | | |
| | | | | 23 | BITCLEAR | | | | |
| | | | | 24 | LOWPASSFILTER | | | | |
| | | | | 25 | PI_CONTORL | | | | |
| | | | | 26 | PI_PROCESS | | | | |
| | | | | 27 | UPCOUNT | | | | |
| | | | | 28 | DOWNCOUNT | | | | |
| 37 | 0h1E25 | User function input8-A | User Input8-A | 0-0xFFFF | 0 | X/A | O | O | <u>p.111</u> |
| 38 | 0h1E26 | User function input8-B | User Input8-B | 0-0xFFFF | 0 | X/A | O | O | <u>p.111</u> |
| 39 | 0h1E27 | User function input8-C | User Input8-C | 0-0xFFFF | 0 | X/A | O | O | <u>p.111</u> |
| 40 | 0h1E28 | User function | User | -32767-32767 | 0 | -/A | O | O | <u>p.111</u> |

| Code | Comm. Address | Name | LCD Display | Setting Range | Initial Value | Property* | V/F | SL | Ref. | |
|------|---------------|------------------------|---------------|----------------|---------------|-----------|-----|----|--------------|--------------|
| | | output8 | Output8 | | | | | | | |
| 41 | 0h1E29 | User function9 | User Func9 | 0 | NOP | 0:NOP | X/A | O | O | <u>p.111</u> |
| 1 | | | | ADD | | | | | | |
| 2 | | | | SUB | | | | | | |
| 3 | | | | ADDSUB | | | | | | |
| 4 | | | | MIN | | | | | | |
| 5 | | | | MAX | | | | | | |
| 6 | | | | ABS | | | | | | |
| 7 | | | | NEGATE | | | | | | |
| 8 | | | | MPYDIV | | | | | | |
| 9 | | | | REMAINDER | | | | | | |
| 10 | | | | COMPARE-GT | | | | | | |
| 11 | | | | COMPARE-GEQ | | | | | | |
| 12 | | | | COMPARE-EQUAL | | | | | | |
| 13 | | | | COMPARE-NEQUAL | | | | | | |
| 14 | | | | TIMER | | | | | | |
| 15 | | | | LIMIT | | | | | | |
| 16 | | | | AND | | | | | | |
| 17 | | | | OR | | | | | | |
| 18 | | | | XOR | | | | | | |
| 19 | | | | ANDOR | | | | | | |
| 20 | | | | SWITCH | | | | | | |
| 21 | | | | BITTEST | | | | | | |
| 22 | | | | BITSET | | | | | | |
| 23 | | | | BITCLEAR | | | | | | |
| 24 | | | | LOWPASSFILTER | | | | | | |
| 25 | | | | PI_CONTORL | | | | | | |
| 26 | | | | PI_PROCESS | | | | | | |
| 27 | | | | UPCOUNT | | | | | | |
| 28 | | | | DOWNCOUNT | | | | | | |
| 42 | 0h1E2A | User function input9-A | User Input9-A | 0-0xFFFF | 0 | X/A | O | O | <u>p.111</u> | |
| 43 | 0h1E2B | User function input9-B | User Input9-B | 0-0xFFFF | 0 | X/A | O | O | <u>p.111</u> | |

Table of Functions

| Code | Comm. Address | Name | LCD Display | Setting Range | Initial Value | Property* | V/F | SL | Ref. | |
|------|---------------|-------------------------|---------------|---------------|----------------|-----------|-----|----|--------------|--------------|
| 44 | 0h1E2C | User function input9-C | User Input9-C | 0-0xFFFF | 0 | X/A | O | O | <u>p.111</u> | |
| 45 | 0h1E2D | User function output9 | User Output9 | -32767-32767 | 0 | -/A | O | O | <u>p.111</u> | |
| 46 | 0h1E2E | User function10 | User Func10 | 0 | NOP | 0:NOP | X/A | O | O | <u>p.111</u> |
| | | | | 1 | ADD | | | | | |
| | | | | 2 | SUB | | | | | |
| | | | | 3 | ADDSUB | | | | | |
| | | | | 4 | MIN | | | | | |
| | | | | 5 | MAX | | | | | |
| | | | | 6 | ABS | | | | | |
| | | | | 7 | NEGATE | | | | | |
| | | | | 8 | MPYDIV | | | | | |
| | | | | 9 | REMAINDER | | | | | |
| | | | | 10 | COMPARE-GT | | | | | |
| | | | | 11 | COMPARE-GEQ | | | | | |
| | | | | 12 | COMPARE-EQUAL | | | | | |
| | | | | 13 | COMPARE-NEQUAL | | | | | |
| | | | | 14 | TIMER | | | | | |
| | | | | 15 | LIMIT | | | | | |
| | | | | 16 | AND | | | | | |
| | | | | 17 | OR | | | | | |
| | | | | 18 | XOR | | | | | |
| | | | | 19 | ANDOR | | | | | |
| | | | | 20 | SWITCH | | | | | |
| | | | | 21 | BITTEST | | | | | |
| | | | | 22 | BITSET | | | | | |
| | | | | 23 | BITCLEAR | | | | | |
| | | | | 24 | LOWPASSFILTER | | | | | |
| | | | | 25 | PI_CONTORL | | | | | |
| | | | | 26 | PI_PROCESS | | | | | |
| | | | | 27 | UPCOUNT | | | | | |
| | | | | 28 | DOWNCOUNT | | | | | |
| 47 | 0h1E2F | User function input10-A | User Input10- | 0-0xFFFF | 0 | X/A | O | O | <u>p.111</u> | |

| Code | Comm. Address | Name | LCD Display | Setting Range | Initial Value | Property* | V/F | SL | Ref. | |
|------|---------------|-------------------------|----------------|----------------|---------------|-----------|-----|----|--------------|--------------|
| | | | A | | | | | | | |
| 48 | 0h1E30 | User function input10-B | User Input10-B | 0-0xFFFF | 0 | X/A | O | O | <u>p.111</u> | |
| 49 | 0h1E31 | User function input10-C | User Input10-C | 0-0xFFFF | 0 | X/A | O | O | <u>p.111</u> | |
| 50 | 0h1E32 | User function output10 | User Output10 | -32767-32767 | 0 | -/A | O | O | <u>p.111</u> | |
| 51 | 0h1E33 | User function11 | User Func11 | 0 | NOP | 0:NOP | X/A | O | O | <u>p.111</u> |
| 1 | | | | ADD | | | | | | |
| 2 | | | | SUB | | | | | | |
| 3 | | | | ADDSUB | | | | | | |
| 4 | | | | MIN | | | | | | |
| 5 | | | | MAX | | | | | | |
| 6 | | | | ABS | | | | | | |
| 7 | | | | NEGATE | | | | | | |
| 8 | | | | MPYDIV | | | | | | |
| 9 | | | | REMAINDER | | | | | | |
| 10 | | | | COMPARE-GT | | | | | | |
| 11 | | | | COMPARE-GEQ | | | | | | |
| 12 | | | | COMPARE-EQUAL | | | | | | |
| 13 | | | | COMPARE-NEQUAL | | | | | | |
| 14 | | | | TIMER | | | | | | |
| 15 | | | | LIMIT | | | | | | |
| 16 | | | | AND | | | | | | |
| 17 | | | | OR | | | | | | |
| 18 | | | | XOR | | | | | | |
| 19 | | | | ANDOR | | | | | | |
| 20 | | | | SWITCH | | | | | | |
| 21 | | | | BITTEST | | | | | | |
| 22 | | | | BITSET | | | | | | |
| 23 | | | | BITCLEAR | | | | | | |
| 24 | | | | LOWPASSFILTER | | | | | | |
| 25 | | | | PI_CONTORL | | | | | | |

Function Table

Table of Functions

| Code | Comm. Address | Name | LCD Display | Setting Range | Initial Value | Property* | V/F | SL | Ref. |
|-------------------|---------------|-------------------------|----------------|---------------|---------------|-----------|-----|----|--------------|
| | | | | 26 PI_PROCESS | | | | | |
| | | | | 27 UPCOUNT | | | | | |
| | | | | 28 DOWNCOUNT | | | | | |
| 52 | 0h1E34 | User function input11-A | User Input11-A | 0-0xFFFF | 0 | X/A | O | O | <u>p.111</u> |
| 53 | 0h1E35 | User function input11-B | User Input11-B | 0-0xFFFF | 0 | X/A | O | O | <u>p.111</u> |
| 54 | 0h1E36 | User function input11-C | User Input11-C | 0-0xFFFF | 0 | X/A | O | O | <u>p.111</u> |
| 55 | 0h1E37 | User function output11 | User Output11 | -32767-32767 | 0 | -/A | O | O | <u>p.111</u> |
| 56 | 0h1E38 | User function12 | User Func12 | 0 NOP | 0:NOP | X/A | O | O | <u>p.111</u> |
| 1 ADD | | | | | | | | | |
| 2 SUB | | | | | | | | | |
| 3 ADDSUB | | | | | | | | | |
| 4 MIN | | | | | | | | | |
| 5 MAX | | | | | | | | | |
| 6 ABS | | | | | | | | | |
| 7 NEGATE | | | | | | | | | |
| 8 MPYDIV | | | | | | | | | |
| 9 REMAINDER | | | | | | | | | |
| 10 COMPARE-GT | | | | | | | | | |
| 11 COMPARE-GEQ | | | | | | | | | |
| 12 COMPARE-EQUAL | | | | | | | | | |
| 13 COMPARE-NEQUAL | | | | | | | | | |
| 14 TIMER | | | | | | | | | |
| 15 LIMIT | | | | | | | | | |
| 16 AND | | | | | | | | | |
| 17 OR | | | | | | | | | |
| 18 XOR | | | | | | | | | |
| 19 ANDOR | | | | | | | | | |
| 20 SWITCH | | | | | | | | | |
| 21 BITTEST | | | | | | | | | |

| Code | Comm. Address | Name | LCD Display | Setting Range | Initial Value | Property* | V/F | SL | Ref. |
|-------------------|---------------|-------------------------|----------------|------------------|---------------|-----------|-----|----|--------------|
| | | | | 22 BITSET | | | | | |
| | | | | 23 BITCLEAR | | | | | |
| | | | | 24 LOWPASSFILTER | | | | | |
| | | | | 25 PI_CONTORL | | | | | |
| | | | | 26 PI_PROCESS | | | | | |
| | | | | 27 UPCOUNT | | | | | |
| | | | | 28 DOWNCOUNT | | | | | |
| 57 | 0h1E39 | User function input12-A | User Input12-A | 0-0xFFFF | 0 | X/A | O | O | <u>p.111</u> |
| 58 | 0h1E3A | User function input12-B | User Input12-B | 0-0xFFFF | 0 | X/A | O | O | <u>p.111</u> |
| 59 | 0h1E3B | User function input12-C | User Input12-C | 0-0xFFFF | 0 | X/A | O | O | <u>p.111</u> |
| 60 | 0h1E3C | User function output12 | User Output12 | -32767-32767 | 0 | -/A | O | O | <u>p.111</u> |
| 61 | 0h1E3D | User function13 | User Func13 | 0 NOP | 0:NOP | X/A | O | O | <u>p.111</u> |
| 1 ADD | | | | | | | | | |
| 2 SUB | | | | | | | | | |
| 3 ADDSUB | | | | | | | | | |
| 4 MIN | | | | | | | | | |
| 5 MAX | | | | | | | | | |
| 6 ABS | | | | | | | | | |
| 7 NEGATE | | | | | | | | | |
| 8 MPYDIV | | | | | | | | | |
| 9 REMAINDER | | | | | | | | | |
| 10 COMPARE-GT | | | | | | | | | |
| 11 COMPARE-GEQ | | | | | | | | | |
| 12 COMPARE-EQUAL | | | | | | | | | |
| 13 COMPARE-NEQUAL | | | | | | | | | |
| 14 TIMER | | | | | | | | | |
| 15 LIMIT | | | | | | | | | |
| 16 AND | | | | | | | | | |
| 17 OR | | | | | | | | | |

Table of Functions

| Code | Comm. Address | Name | LCD Display | Setting Range | Initial Value | Property* | V/F | SL | Ref. |
|------|---------------|-------------------------|----------------|-------------------|---------------|-----------|-----|----|-----------------------|
| | | | | 18 XOR | | | | | |
| | | | | 19 ANDOR | | | | | |
| | | | | 20 SWITCH | | | | | |
| | | | | 21 BITTEST | | | | | |
| | | | | 22 BITSET | | | | | |
| | | | | 23 BITCLEAR | | | | | |
| | | | | 24 LOWPASSFILTER | | | | | |
| | | | | 25 PI_CONTORL | | | | | |
| | | | | 26 PI_PROCESS | | | | | |
| | | | | 27 UPCOUNT | | | | | |
| | | | | 28 DOWNCOUNT | | | | | |
| 62 | 0h1E3E | User function input13-A | User Input13-A | 0-0xFFFF | 0 | X/A | O | O | p.111 |
| 63 | 0h1E3F | User function input13-B | User Input13-B | 0-0xFFFF | 0 | X/A | O | O | p.111 |
| 64 | 0h1E40 | User function input13-C | User Input13-C | 0-0xFFFF | 0 | X/A | O | O | p.111 |
| 65 | 0h1E41 | User function output13 | User Output13 | -32767-32767 | 0 | -/A | O | O | p.111 |
| 66 | 0h1E42 | User function14 | User Func14 | 0 NOP | 0:NOP | X/A | O | O | p.111 |
| | | | | 1 ADD | | | | | |
| | | | | 2 SUB | | | | | |
| | | | | 3 ADDSUB | | | | | |
| | | | | 4 MIN | | | | | |
| | | | | 5 MAX | | | | | |
| | | | | 6 ABS | | | | | |
| | | | | 7 NEGATE | | | | | |
| | | | | 8 MPYDIV | | | | | |
| | | | | 9 REMAINDER | | | | | |
| | | | | 10 COMPARE-GT | | | | | |
| | | | | 11 COMPARE-GEQ | | | | | |
| | | | | 12 COMPARE-EQUAL | | | | | |
| | | | | 13 COMPARE-NEQUAL | | | | | |

| Code | Comm. Address | Name | LCD Display | Setting Range | Initial Value | Property* | V/F | SL | Ref. | |
|------|---------------|-------------------------|----------------|---------------|---------------|-----------|-----|----|--------------|--------------|
| | | | | 14 | TIMER | | | | | |
| | | | | 15 | LIMIT | | | | | |
| | | | | 16 | AND | | | | | |
| | | | | 17 | OR | | | | | |
| | | | | 18 | XOR | | | | | |
| | | | | 19 | ANDOR | | | | | |
| | | | | 20 | SWITCH | | | | | |
| | | | | 21 | BITTEST | | | | | |
| | | | | 22 | BITSET | | | | | |
| | | | | 23 | BITCLEAR | | | | | |
| | | | | 24 | LOWPASSFILTER | | | | | |
| | | | | 25 | PI_CONTORL | | | | | |
| | | | | 26 | PI_PROCESS | | | | | |
| 27 | UPCOUNT | | | | | | | | | |
| 28 | DOWNCOUNT | | | | | | | | | |
| 67 | 0h1E43 | User function input14-A | User Input14-A | 0-0xFFFF | 0 | X/A | O | O | <u>p.111</u> | |
| 68 | 0h1E44 | User function input14-B | User Input14-B | 0-0xFFFF | 0 | X/A | O | O | <u>p.111</u> | |
| 69 | 0h1E45 | User function input14-C | User Input14-C | 0-0xFFFF | 0 | X/A | O | O | <u>p.111</u> | |
| 70 | 0h1E46 | User function output14 | User Output14 | -32767-32767 | 0 | -/A | O | O | <u>p.111</u> | |
| 71 | 0h1E47 | User function15 | User Func15 | 0 | NOP | 0:NOP | X/A | O | O | <u>p.111</u> |
| | | | | 1 | ADD | | | | | |
| | | | | 2 | SUB | | | | | |
| | | | | 3 | ADDSUB | | | | | |
| | | | | 4 | MIN | | | | | |
| | | | | 5 | MAX | | | | | |
| | | | | 6 | ABS | | | | | |
| | | | | 7 | NEGATE | | | | | |
| | | | | 8 | MPYDIV | | | | | |
| | | | | 9 | REMAINDER | | | | | |
| | | | | 10 | COMPARE-GT | | | | | |

Function Table

Table of Functions

| Code | Comm. Address | Name | LCD Display | Setting Range | Initial Value | Property* | V/F | SL | Ref. |
|------|---------------|-------------------------|----------------|-------------------|---------------|-----------|-----|----|--------------|
| | | | | 11 COMPARE-GEQ | | | | | |
| | | | | 12 COMPARE-EQUAL | | | | | |
| | | | | 13 COMPARE-NEQUAL | | | | | |
| | | | | 14 TIMER | | | | | |
| | | | | 15 LIMIT | | | | | |
| | | | | 16 AND | | | | | |
| | | | | 17 OR | | | | | |
| | | | | 18 XOR | | | | | |
| | | | | 19 ANDOR | | | | | |
| | | | | 20 SWITCH | | | | | |
| | | | | 21 BITTEST | | | | | |
| | | | | 22 BITSET | | | | | |
| | | | | 23 BITCLEAR | | | | | |
| | | | | 24 LOWPASSFILTER | | | | | |
| | | | | 25 PI_CONTORL | | | | | |
| | | | | 26 PI_PROCESS | | | | | |
| | | | | 27 UPCOUNT | | | | | |
| | | | | 28 DOWNCOUNT | | | | | |
| 72 | 0h1E48 | User function input15-A | User Input15-A | 0-0xFFFF | 0 | X/A | O | O | <u>p.111</u> |
| 73 | 0h1E49 | User function input15-B | User Input15-B | 0-0xFFFF | 0 | X/A | O | O | <u>p.111</u> |
| 74 | 0h1E4A | User function input15-C | User Input15-C | 0-0xFFFF | 0 | X/A | O | O | <u>p.111</u> |
| 75 | 0h1E4B | User function output15 | User Output15 | -32767-32767 | 0 | -/A | O | O | <u>p.111</u> |
| 76 | 0h1E4C | User function 16 | User Func16 | 0 NOP | 0:NOP | X/A | O | O | <u>p.111</u> |
| | | | | 1 ADD | | | | | |
| | | | | 2 SUB | | | | | |
| | | | | 3 ADDSUB | | | | | |
| | | | | 4 MIN | | | | | |
| | | | | 5 MAX | | | | | |
| | | | | 6 ABS | | | | | |

| Code | Comm. Address | Name | LCD Display | Setting Range | Initial Value | Property* | V/F | SL | Ref. | |
|------|---------------|-------------------------|----------------|---------------|----------------|-----------|-----|----|------|-----------------------|
| | | | | 7 | NEGATE | | | | | |
| | | | | 8 | MPYDIV | | | | | |
| | | | | 9 | REMAINDER | | | | | |
| | | | | 10 | COMPARE-GT | | | | | |
| | | | | 11 | COMPARE-GEQ | | | | | |
| | | | | 12 | COMPARE-EQUAL | | | | | |
| | | | | 13 | COMPARE-NEQUAL | | | | | |
| | | | | 14 | TIMER | | | | | |
| | | | | 15 | LIMIT | | | | | |
| | | | | 16 | AND | | | | | |
| | | | | 17 | OR | | | | | |
| | | | | 18 | XOR | | | | | |
| | | | | 19 | ANDOR | | | | | |
| | | | | 20 | SWITCH | | | | | |
| | | | | 21 | BITTEST | | | | | |
| | | | | 22 | BITSET | | | | | |
| | | | | 23 | BITCLEAR | | | | | |
| | | | | 24 | LOWPASSFILTER | | | | | |
| | | | | 25 | PI_CONTORL | | | | | |
| | | | | 26 | PI_PROCESS | | | | | |
| | | | | 27 | UPCOUNT | | | | | |
| | | | | 28 | DOWNCOUNT | | | | | |
| 77 | 0h1E4D | User function input16-A | User Input16-A | 0-0xFFFF | | 0 | X/A | O | O | p.111 |
| 78 | 0h1E4E | User function input16-B | User Input16-B | 0-0xFFFF | | 0 | X/A | O | O | p.111 |
| 79 | 0h1E4F | User function input16-C | User Input16-C | 0-0xFFFF | | 0 | X/A | O | O | p.111 |
| 80 | 0h1E50 | User function output16 | User Output16 | -32767-32767 | | 0 | -/A | O | O | p.111 |
| 81 | 0h1E51 | User function 17 | User Func17 | 0 | NOP | 0:NOP | X/A | O | O | p.111 |
| | | | | 1 | ADD | | | | | |
| | | | | 2 | SUB | | | | | |

Function Table

Table of Functions

| Code | Comm. Address | Name | LCD Display | Setting Range | Initial Value | Property* | V/F | SL | Ref. |
|------|---------------|-------------------------|----------------|-------------------|---------------|-----------|-----|----|-----------------------|
| | | | | 3 ADDSUB | | | | | |
| | | | | 4 MIN | | | | | |
| | | | | 5 MAX | | | | | |
| | | | | 6 ABS | | | | | |
| | | | | 7 NEGATE | | | | | |
| | | | | 8 MPYDIV | | | | | |
| | | | | 9 REMAINDER | | | | | |
| | | | | 10 COMPARE-GT | | | | | |
| | | | | 11 COMPARE-GEQ | | | | | |
| | | | | 12 COMPARE-EQUAL | | | | | |
| | | | | 13 COMPARE-NEQUAL | | | | | |
| | | | | 14 TIMER | | | | | |
| | | | | 15 LIMIT | | | | | |
| | | | | 16 AND | | | | | |
| | | | | 17 OR | | | | | |
| | | | | 18 XOR | | | | | |
| | | | | 19 ANDOR | | | | | |
| | | | | 20 SWITCH | | | | | |
| | | | | 21 BITTEST | | | | | |
| | | | | 22 BITSET | | | | | |
| | | | | 23 BITCLEAR | | | | | |
| | | | | 24 LOWPASSFILTER | | | | | |
| | | | | 25 PI_CONTORL | | | | | |
| | | | | 26 PI_PROCESS | | | | | |
| | | | | 27 UPCOUNT | | | | | |
| | | | | 28 DOWNCOUNT | | | | | |
| 82 | 0h1E52 | User function input17-A | User Input17-A | 0-0xFFFF | 0 | X/A | O | O | p.111 |
| 83 | 0h1E53 | User function input17-B | User Input17-B | 0-0xFFFF | 0 | X/A | O | O | p.111 |
| 84 | 0h1E54 | User function input17-C | User Input17-C | 0-0xFFFF | 0 | X/A | O | O | p.111 |
| 85 | 0h1E55 | User function | User | -32767-32767 | 0 | -/A | O | O | p.111 |

| Code | Comm. Address | Name | LCD Display | Setting Range | Initial Value | Property* | V/F | SL | Ref. | |
|------|---------------|-------------------------|----------------|----------------|---------------|-----------|-----|----|--------------|--------------|
| | | output17 | Output17 | | | | | | | |
| 86 | 0h1E56 | User function 18 | User Func18 | 0 | NOP | 0:NOP | X/A | O | O | <u>p.111</u> |
| 1 | | | | ADD | | | | | | |
| 2 | | | | SUB | | | | | | |
| 3 | | | | ADDSUB | | | | | | |
| 4 | | | | MIN | | | | | | |
| 5 | | | | MAX | | | | | | |
| 6 | | | | ABS | | | | | | |
| 7 | | | | NEGATE | | | | | | |
| 8 | | | | MPYDIV | | | | | | |
| 9 | | | | REMAINDER | | | | | | |
| 10 | | | | COMPARE-GT | | | | | | |
| 11 | | | | COMPARE-GEQ | | | | | | |
| 12 | | | | COMPARE-EQUAL | | | | | | |
| 13 | | | | COMPARE-NEQUAL | | | | | | |
| 14 | | | | TIMER | | | | | | |
| 15 | | | | LIMIT | | | | | | |
| 16 | | | | AND | | | | | | |
| 17 | | | | OR | | | | | | |
| 18 | | | | XOR | | | | | | |
| 19 | | | | ANDOR | | | | | | |
| 20 | | | | SWITCH | | | | | | |
| 21 | | | | BITTEST | | | | | | |
| 22 | | | | BITSET | | | | | | |
| 23 | | | | BITCLEAR | | | | | | |
| 24 | | | | LOWPASSFILTER | | | | | | |
| 25 | | | | PI_CONTORL | | | | | | |
| 26 | | | | PI_PROCESS | | | | | | |
| 27 | | | | UPCOUNT | | | | | | |
| 28 | | | | DOWNCOUNT | | | | | | |
| 87 | 0h1E57 | User function input18-A | User Input18-A | 0-0xFFFF | 0 | X/A | O | O | <u>p.111</u> | |
| 88 | 0h1E58 | User function input18-B | User Input18-B | 0-0xFFFF | 0 | X/A | O | O | <u>p.111</u> | |

Table of Functions

| Code | Comm. Address | Name | LCD Display | Setting Range | Initial Value | Property* | V/F | SL | Ref. |
|------|---------------|-------------------------|----------------|---------------|---------------|-----------|-----|----|--------------|
| | | | B | | | | | | |
| 89 | 0h1E59 | User function input18-C | User Input18-C | 0-0xFFFF | 0 | X/A | O | O | <u>p.111</u> |
| 90 | 0h1E5A | User function output18 | User Output18 | -32767-32767 | 0 | -/A | O | O | <u>p.111</u> |

8.14 Groups for LCD Keypad Only

8.14.1 Trip Mode (TRP Last-x)

| Code | Name | LCD Display | Setting Range | Initial Value | Ref. |
|------|---|----------------|---------------|---------------|------|
| 00 | Trip type display | Trip Name(x) | - | - | - |
| 01 | Frequency reference at trip | Output Freq | - | - | - |
| 02 | Output current at trip | Output Current | - | - | - |
| 03 | Acceleration/Deceleration state at trip | Inverter State | - | - | - |
| 04 | DC section state | DCLink Voltage | - | - | - |
| 05 | NTC temperature | Temperature | - | - | - |
| 06 | Input terminal state | DI Status | - | 0000 0000 | - |
| 07 | Output terminal state | DO Status | - | 000 | - |
| 08 | Trip time after Power on | Trip On Time | - | 0/00/00 00:00 | - |
| 09 | Trip time after operation start | Trip Run Time | - | 0/00/00 00:00 | - |
| 10 | | | | | |
| 10 | Delete trip history | Trip Delete? | 0 | No | |
| | | | 1 | Yes | |

8.14.2 Config Mode (CNF)

| Code | Name | LCD Display | Setting Range | Initial Value | Ref. |
|------|----------------------------|----------------|---------------|---------------|-----------------------|
| 00 | Jump code | Jump Code | 1-99 | 42 | p.48 |
| 01 | Keypad language selection | Language Sel | 0 : English | 0 : English | p.193 |
| 02 | LCD constrast adjustment | LCD Contrast | - | - | p.177 |
| 03 | Multi keypad ID | Multi KPD ID | 3-99 | 3 | p.109 |
| 10 | Inverter S/W version | Inv S/W Ver | - | - | p.177 |
| 11 | LCD keypad S/W version | Keypad S/W Ver | - | - | p.177 |
| 12 | LCD keypad title version | KPD Title Ver | - | - | p.177 |
| 20 | Status window display item | Anytime Para | 0 Frequency | 0: Frequency | p.193 |

Table of Functions

| Code | Name | LCD Display | Setting Range | Initial Value | Ref. |
|------------------|-----------------------------|----------------|------------------|-------------------|-----------------------|
| 21 | Monitor mode display item1 | Monitor Line-1 | 1 Speed | 0: Frequency | p.193 |
| 22 | Monitor mode display item2 | Monitor Line-2 | 2 Output Current | 2: Output Current | p.193 |
| 23 | Monitor mode display item3 | Monitor Line-3 | 3 Output | 3: Output Voltage | p.193 |
| | | | 4 Output Power | | |
| | | | 5 WHour | | |
| | | | 6 DCLink | | |
| | | | 7 DI State | | |
| | | | 8 DO State | | |
| | | | 9 V1 Monitor(V) | | |
| | | | 10 V1 Monitor(%) | | |
| | | | 13 V2 Monitor(V) | | |
| | | | 14 V2 Monitor(%) | | |
| | | | 15 I2 | | |
| | | | 16 I2 Monitor(%) | | |
| | | | 17 PID Output | | |
| | | | 18 PID Ref Value | | |
| 19 PID Fdb Value | | | | | |
| 20 Torque | | | | | |
| 21 Torque Limit | | | | | |
| 23 Speed Limit | | | | | |
| 24 Load Speed | | | | | |
| 24 | Monitor mode initialization | Mon Mode Init | 0 No | 0: No | p.193 |
| | | | 1 Yes | | |
| 30 | Option slot 1 type display | Option-1 Type | 0 None | 0: None | p.177 |
| 31 | Option slot 2 type display | Option-2 Type | 6 Ethernet | 0: None | p.177 |
| 32 | Option slot 3 type display | Option-3 Type | 9 CANopen | 0: None | p.177 |
| 40 | Parameter initialization | Parameter Init | 0 No | | p.171 |
| | | | 1 All Grp | | |
| | | | 2 DRV Grp | | |
| | | | 3 BAS Grp | | |
| | | | 4 ADV Grp | | |
| | | | 5 CON Grp | | |
| | | | 6 IN Grp | | |
| 7 OUT Grp | | | | | |

| Code | Name | LCD Display | Setting Range | Initial Value | Ref. |
|------|-------------------------------------|-----------------|------------------------------|---------------|-----------------------|
| | | | 8 COM Grp | | |
| | | | 9 APP Grp | | |
| | | | 11 APO Grp ⁶¹ | | |
| | | | 12 PRT Grp | | |
| | | | 13 M2 Grp | | |
| 41 | Display changed Parameter | Changed Para | 0 View All 1 View Changed | 0:View All | p.174 |
| 42 | Multi key item | Multi Key Sel | 0 None | 0:None | p.174 |
| | | | 1 JOG Key | | |
| | | | 2 Local/Remote | | |
| | | | 3 UserGrp SelKey | | |
| | | | 4 Multi KPD | | |
| 43 | Macro function item | Macro Select | 0 None | 0:None | - |
| 44 | Trip history deletion | Erase All Trip | 0 No | 0:No | p.177 |
| | | | 1 Yes | | |
| 45 | User registration code deletion | UserGrp AllDel | 0 No | 0:No | p.174 |
| | | | 1 Yes | | |
| 46 | Read parameters | Parameter Read | 0 No | 0:No | p.171 |
| | | | 1 Yes | | |
| 47 | Write parameters | Parameter Write | 0 No | 0: No | p.171 |
| | | | 1 Yes | | |
| 48 | Save parameters | Parameter Save | 0 No | 0:No | p.171 |
| | | | 1 Yes | | |
| 50 | Hide parameter mode | View Lock Set | 0-9999 | Un-locked | p.172 |
| 51 | Password for hiding parameter mode | View Lock Pw | 0-9999 | Password | p.172 |
| 52 | Lock parameter edit | Key Lock Set | 0-9999 | Un-locked | p.173 |
| 53 | Password for locking parameter edit | Key Lock Pw | 0-9999 | Password | p.173 |
| 60 | Additional title update | Add Title Up | 0 No | 0:No | p.177 |
| | | | 1 Yes | | |
| 61 | Simple parameter setting | Easy Start On | 0 No | 1:Yes | p.174 |
| | | | 1 Yes | | |
| 62 | Power consumption initialization | WHCount Reset | 0 No | 0:No | p.177 |
| | | | 1 Yes | | |

⁶¹ Supported only Extension I/O(Optional)

Table of Functions

| Code | Name | LCD Display | Setting Range | | Initial Value | Ref. |
|------|--|--------------|-------------------------------|-----|---------------|--------------|
| 70 | Accumulated inverter motion time | On-time | Year/month/day hour:minute | | - | <u>p.196</u> |
| 71 | Accumulated inverter operation time | Run-time | Year/month/day hour:minute | | - | <u>p.196</u> |
| 72 | Accumulated inverter operation time initialization | Time Reset | 0 | No | 0:No | <u>p.196</u> |
| | | | 1 | Yes | | |
| 74 | Accumulated cooling fan operation time | Fan Time | Year/month/day hour:minute | | - | <u>p.196</u> |
| 75 | Reset of accumulated cooling fan operation time | Fan Time Rst | 0 | No | 0:No | <u>p.196</u> |
| | | | 1 | Yes | | |

9 Troubleshooting

This chapter explains how to troubleshoot a problem when inverter protective functions, fault trips, warning signals, or a fault occurs. If the inverter does not work normally after following the suggested troubleshooting steps, please contact the LSIS customer service center.

9.1 Trips and Warnings

When the inverter detects a fault, it stops the operation (trips) or sends out a warning signal. When a trip or warning occurs, the keypad displays the information briefly. If the LCD keypad is used, detailed information is shown on the LCD display. Users can read the warning message at Pr.90. When more than 2 trips occur at roughly the same time, the keypad (basic keypad with 7-segment display) displays the higher priority fault trip information, while the LCD keypad shows the information for the fault trip that occurred first.

The fault conditions can be categorized as follows:

- Level: When the fault is corrected, the trip or warning signal disappears and the fault is not saved in the fault history.
- Latch: When the fault is corrected and a reset input signal is provided, the trip or warning signal disappears.
- Fatal: When the fault is corrected, the fault trip or warning signal disappears only after the user turns off the inverter, waits until the charge indicator light goes off, and turns the inverter on again. If the the inverter is still in a fault condition after powering it on again, please contact the supplier or the LSIS customer service center.

9.1.1 Fault Trips

Protection Functions for Output Current and Input Voltage

| Keypad Display | LCD Display | Type | Description |
|----------------|---------------|-------|--|
| | Over Load | Latch | Displayed when the motor overload trip is activated and the actual load level exceeds the set level. Operates when Pr.20 is set to a value other than 0. |
| | Under Load | Latch | Displayed when the motor underload trip is activated and the actual load level is less than the set level. Operates when Pr.27 is set to a value other than 0. |
| | Over Current1 | Latch | Displayed when inverter output current exceeds 200% of the rated current. |

| Keypad Display | LCD Display | Type | Description |
|----------------|----------------|-------|--|
| | Over Voltage | Latch | Displayed when internal DC circuit voltage exceeds the specified value. |
| | Low Voltage | Level | Displayed when internal DC circuit voltage is less than the specified value. |
| | Low Voltage2 | Latch | Displayed when internal DC circuit voltage is less than the specified value during inverter operation. |
| | Ground Trip* | Latch | Displayed when a ground fault trip occurs on the output side of the inverter and causes the current to exceed the specified value. The specified value varies depending on inverter capacity. |
| | E-Thermal | Latch | Displayed based on inverse time-limit thermal characteristics to prevent motor overheating. Operates when Pr.40 is set to a value other than 0. |
| | Out Phase Open | Latch | Displayed when a 3-phase inverter output has one or more phases in an open circuit condition. Operates when bit 1 of Pr.05 is set to 1. |
| | In Phase Open | Latch | Displayed when a 3-phase inverter input has one or more phases in an open circuit condition. Operates only when bit 2 of Pr.05 is set to 1. |
| | Inverter OLT | Latch | Displayed when the inverter has been protected from overload and resultant overheating, based on inverse time-limit thermal characteristics. Allowable overload rates for the inverter are 150% for 1 min and 200% for 4 sec. Protection is based on inverter rated capacity, and may vary depending on the device's capacity. |
| | No Motor Trip | Latch | Displayed when the motor is not connected during inverter operation. Operates when Pr.31 is set to 1. |

* S100 inverters rated for 4.0kW or less do not support the ground fault trip (GFT) feature.

Therefore, an over current trip (OCT) or over voltage trip (OVT) may occur when there is a low-resistance ground fault.



Protection Functions Using Abnormal Internal Circuit Conditions and External Signals

| Keypad Display | LCD Display | Type | Description |
|----------------|---------------|-------|---|
| | Over Heat | Latch | Displayed when the temperature of the inverter heat sink exceeds the specified value. |
| | Over Current2 | Latch | Displayed when the DC circuit in the inverter detects a specified level of excessive, short circuit current. |
| | External Trip | Latch | Displayed when an external fault signal is provided by the multi-function terminal. Set one of the multi-function input terminals at In.65-71 to 4 (External Trip) to enable external trip. |

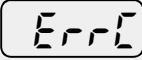
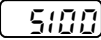

| Keypad Display | LCD Display | Type | Description |
|----------------|--------------------|-------|---|
| | BX | Level | Displayed when the inverter output is blocked by a signal provided from the multi-function terminal. Set one of the multi-function input terminals at In.65-71 to 5 (BX) to enable input block function. |
| | H/W-Diag | Fatal | Displayed when an error is detected in the memory (EEPROM), analog-digital converter output (ADC Off Set), or CPU watchdog (Watch Dog-1, Watch Dog-2). EEP Err: An error in reading/writing parameters due to keypad or memory (EEPROM) fault. ADC Off Set: An error in the current sensing circuit (U/V/W terminal, current sensor, etc.). |
| | NTC Open | Latch | Displayed when an error is detected in the temperature sensor of the Insulated Gate Bipolar Transistor (IGBT). |
| | Fan Trip | Latch | Displayed when an error is detected in the cooling fan. Set Pr.79 to 0 to activate fan trip (for models below 22kW capacity). |
| | Pre-PID Fail | Latch | Displayed when pre-PID is operating with functions set at AP.34–AP.36. A fault trip occurs when a controlled variable (PID feedback) is measured below the set value and the low feedback continues, as it is treated as a load fault. |
| | Ext-Brake | Latch | Operates when the external brake signal is provided by the multi-function terminal. Occurs when the inverter output starting current remains below the set value at Ad.41. Set either OU.31 or OU.32 to 35 (BR Control). |
| | Safety A(B) Err | Level | Displayed when at least one of the two safety input signals is off. |

Protection Functions for Communication Options

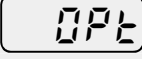
| Keypad Display | LCD Display | Type | Description |
|----------------|---------------|-------|--|
| | Lost Command | Level | Displayed when a frequency or operation command error is detected during inverter operation by controllers other than the keypad (e.g., using a terminal block and a communication mode). Activate by setting Pr.12 to any value other than 0. |
| | IO Board Trip | Latch | Displayed when the I/O board or external communication card is not connected to the inverter or there is a bad connection. |

| Keypad Display | LCD Display | Type | Description |
|---|----------------|-------|--|
|  | | | Displayed when the  error code continues for more than 5 sec. (‘Errc’-> ‘-rrc’-> E-rc’-> ‘Er-c’-> ‘Err-’-> ‘--rc’-> ‘Er--’-> ‘- - - -’-> ‘Errc’-> ...) |
|  | ParaWrite Trip | Latch | Displayed when communication fails during parameter writing. Occurs when using an LCD keypad due to a control cable fault or a bad connection. |
|  | Option Trip-1 | Latch | Displayed when a communication error is detected between the inverter and the communication board. Occurs when the communication option card is installed. |

9.1.2 Warning Messages

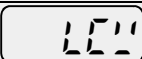
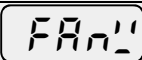
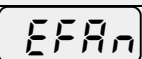
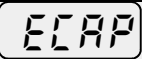
| Keypad Display | LCD Display | Description |
|---|---------------|--|
|  | Over Load | Displayed when the motor is overloaded. Operates when Pr.17 is set to 1. To operate, select 5. Set the digital output terminal or relay (OU.31 or OU.33) to 5 (Over Load) to receive overload warning output signals. |
|  | Under Load | Displayed when the motor is underloaded. Operates when Pr.25 is set to 1. Set the digital output terminal or relay (OU.31 or OU.33) to 7 (Under Load) to receive underload warning output signals. |
|  | INV Over Load | Displayed when the overload time equivalent to 60% of the inverter overheat protection (inverter IOLT) level, is accumulated. Set the digital output terminal or relay (OU.31 or OU.33) to 6 (IOL) to receive inverter overload warning output signals. |
|  | Lost Command | Lost command warning alarm occurs even with Pr.12 set to 0. The warning alarm occurs based on the condition set at Pr.13- 15. Set the digital output terminal or relay (OU.31 or OU.33) to 13 (Lost Command) to receive lost command warning output signals. If the communication settings and status are not suitable for P2P, a Lost Command alarm occurs. |
|  | Fan Warning | Displayed when an error is detected from the cooling fan while Pr.79 is set to 1. Set the digital output terminal or relay (OU.31 or OU.33) to 8 (Fan Warning) to receive fan warning output signals |
|  | Fan Exchange | An alarm occurs when the value set at PRT-86 is less than the value set at PRT-87. To receive fan exchange output signals, set the digital output terminal or relay (OUT-31 or OUT-33) to 38 (Fan Exchange). |
|  | CAP Exchange | An alarm occurs when the value set at PRT-63 is less than the value set at PRT-62 (the value set at PRT-61 must be 2 (Pre Diag)). To receive CAP exchange signals, set the digital output terminal or relay (OUT-31 or OUT-33) to 36 (CAP Exchange). |

| Keypad Display | LCD Display | Description |
|----------------|----------------|---|
| | DB Warn %ED | Displayed when the DB resistor usage rate exceeds the set value. Set the detection level at Pr.66. |
| | Retry Tr Tune | Tr tune error warning alarm is activated when Dr.9 is set to 4. The warning alarm occurs when the motor's rotor time constant (Tr) is either too low or too high. |

9.2 Troubleshooting Fault Trips

When a fault trip or warning occurs due to a protection function, refer to the following table for possible causes and remedies.

| Type | Cause | Remedy |
|---------------------------|---|--|
| Over Load | The load is greater than the motor's rated capacity. | Ensure that the motor and inverter have appropriate capacity ratings. |
| | The set value for the overload trip level (Pr.21) is too low. | Increase the set value for the overload trip level. |
| Under Load | There is a motor-load connection problem. | Replace the motor and inverter with models with lower capacity. |
| | The set value for underload level (Pr.29, Pr.30) is less than the system's minimum load. | Reduce the set value for the underload level. |
| Over Current ¹ | Acc/Dec time is too short, compared to load inertia (GD2). | Increase Acc/Dec time. |
| | The inverter load is greater than the rated capacity. | Replace the inverter with a model that has increased capacity. |
| | The inverter supplied an output while the motor was idling. | Operate the inverter after the motor has stopped or use the speed search function (Cn.60). |
| | The mechanical brake of the motor is operating too fast. | Check the mechanical brake. |
| Over Voltage | Deceleration time is too short for the load inertia (GD2). | Increase the acceleration time. |
| | A generative load occurs at the inverter output. | Use the braking unit. |
| | The input voltage is too high. | Determine if the input voltage is above the specified value. |
| Low Voltage | The input voltage is too low. | Determine if the input voltage is below the specified value. |
| | A load greater than the power capacity is connected to the system (e.g., a welder, direct motor connection, etc.) | Increase the power capacity. |
| | The magnetic contactor connected to the | Replace the magnetic contactor. |

| Type | Cause | Remedy |
|---------------------------|---|--|
| | power source has a faulty connection. | |
| Low Voltage ² | The input voltage has decreased during the operation. | Determine if the input voltage is above the specified value. |
| | An input phase-loss has occurred. | Check the input wiring. |
| | The power supply magnetic contactor is faulty. | Replace the magnetic contractor. |
| Ground Trip | A ground fault has occurred in the inverter output wiring. | Check the output wiring. |
| | The motor insulation is damaged. | Replace the motor. |
| E-Thermal | The motor has overheated. | Reduce the load or operation frequency. |
| | The inverter load is greater than the rated capacity. | Replace the inverter with a model that has increased capacity. |
| | The set value for electronic thermal protection is too low. | Set an appropriate electronic thermal level. |
| | The inverter has been operated at low speed for an extended duration. | Replace the motor with a model that supplies extra power to the cooling fan. |
| Output Phase Open | The magnetic contactor on the output side has a connection fault. | Check the magnetic contactor on the output side. |
| | The output wiring is faulty. | Check the output wiring. |
| Input Phase Open | The magnetic contactor on the input side has a connection fault. | Check the magnetic contactor on the input side. |
| | The input wiring is faulty. | Check the input wiring. |
| | The DC link capacitor needs to be replaced. | Replace the DC link capacitor. Contact the retailer or the LSIS customer service center. |
| Inverter OLT | The load is greater than the rated motor capacity. | Replace the motor and inverter with models that have increased capacity. |
| | The torque boost level is too high. | Reduce the torque boost level. |
| Over Heat | There is a problem with the cooling system. | Determine if a foreign object is obstructing the air inlet, outlet, or vent. |
| | The inverter cooling fan has been operated for an extended period. | Replace the cooling fan. |
| | The ambient temperature is too high. | Keep the ambient temperature below 50°C. |
| Over Current ² | Output wiring is short-circuited. | Check the output wiring. |
| | There is a fault with the electronic semiconductor (IGBT). | Do not operate the inverter. Contact the retailer or the LSIS customer service center. |
| NTC Open | The ambient temperature is too low. | Keep the ambient temperature above -10°C. |
| | There is a fault with the internal temperature sensor. | Contact the retailer or the LSIS customer service center. |
| FAN Lock | A foreign object is obstructing the fan's air | Remove the foreign object from the air |

| Type | Cause | Remedy |
|---------------|---|----------------------------|
| | vent. | inlet or outlet. |
| | The cooling fan needs to be replaced. | Replace the cooling fan. |
| IP54 FAN Trip | The fan connector is not connected. | Connect the fan connector. |
| | The fan connector needs to be replaced. | Replace the fan connector. |

9.3 Troubleshooting Other Faults

When a fault other than those identified as fault trips or warnings occurs, refer to the following table for possible causes and remedies.

| Type | Cause | Remedy |
|---|--|---|
| Parameters cannot be set. | The inverter is in operation (driving mode). | Stop the inverter to change to program mode and set the parameter. |
| | The parameter access is incorrect. | Check the correct parameter access level and set the parameter. |
| | The password is incorrect. | Check the password, disable the parameter lock and set the parameter. |
| | Low voltage is detected. | Check the power input to resolve the low voltage and set the parameter. |
| The motor does not rotate. | The frequency command source is set incorrectly. | Check the frequency command source setting. |
| | The operation command source is set incorrectly. | Check the operation command source setting. |
| | Power is not supplied to the terminal R/S/T. | Check the terminal connections R/S/T and U/V/W. |
| | The charge lamp is turned off. | Turn on the inverter. |
| | The operation command is off. | Turn on the operation command (RUN). |
| | The motor is locked. | Unlock the motor or lower the load level. |
| | The load is too high. | Operate the motor independently. |
| | An emergency stop signal is input. | Reset the emergency stop signal. |
| | The wiring for the control circuit terminal is incorrect. | Check the wiring for the control circuit terminal. |
| | The input option for the frequency command is incorrect. | Check the input option for the frequency command. |
| | The input voltage or current for the frequency command is incorrect. | Check the input voltage or current for the frequency command. |
| | The PNP/NPN mode is selected incorrectly. | Check the PNP/NPN mode setting. |
| The frequency command value is too low. | Check the frequency command and input a value above the minimum | |

| Type | Cause | Remedy |
|--|---|--|
| | | frequency. |
| | The [STOP/RESET] key is pressed. | Check that the stoppage is normal, if so resume operation normally. |
| | Motor torque is too low. | Change the operation modes (V/F, IM, and Sensorless). If the fault remains, replace the inverter with a model with increased capacity. |
| The motor rotates in the opposite direction to the command. | The wiring for the motor output cable is incorrect. | Determine if the cable on the output side is wired correctly to the phase (U/V/W) of the motor. |
| | The signal connection between the control circuit terminal (forward/reverse rotation) of the inverter and the forward/reverse rotation signal on the control panel side is incorrect. | Check the forward/reverse rotation wiring. |
| The motor only rotates in one direction. | Reverse rotation prevention is selected. | Remove the reverse rotation prevention. |
| | The reverse rotation signal is not provided, even when a 3-wire sequence is selected. | Check the input signal associated with the 3-wire operation and adjust as necessary. |
| The motor is overheating. | The load is too heavy. | Reduce the load. |
| | | Increase the Acc/Dec time. |
| | | Check the motor parameters and set the correct values. |
| | | Replace the motor and the inverter with models with appropriate capacity for the load. |
| | The ambient temperature of the motor is too high. | Lower the ambient temperature of the motor. |
| The phase-to-phase voltage of the motor is insufficient. | | Use a motor that can withstand phase-to-phase voltages surges greater than the maximum surge voltage. |
| | | Only use motors suitable for applications with inverters. |
| | | Connect the AC reactor to the inverter output (set the carrier frequency to 2 kHz). |
| | The motor fan has stopped or the fan is obstructed with debris. | Check the motor fan and remove any foreign objects. |
| The motor stops during acceleration or when connected to load. | The load is too high. | Reduce the load. |
| | | Replace the motor and the inverter with models with capacity appropriate for the load. |

| Type | Cause | Remedy |
|--|--|--|
| The motor does not accelerate. /The acceleration time is too long. | The frequency command value is low. | Set an appropriate value. |
| | The load is too high. | Reduce the load and increase the acceleration time. Check the mechanical brake status. |
| | The acceleration time is too long. | Change the acceleration time. |
| | The combined values of the motor properties and the inverter parameter are incorrect. | Change the motor related parameters. |
| | The stall prevention level during acceleration is low. | Change the stall prevention level. |
| | The stall prevention level during operation is low. | Change the stall prevention level. |
| | Starting torque is insufficient. | Change to vector control operation mode. If the fault is still not corrected, replace the inverter with a model with increased capacity. |
| Motor speed varies during operation. | There is a high variance in load. | Replace the motor and inverter with models with increased capacity. |
| | The input voltage varies. | Reduce input voltage variation. |
| | Motor speed variations occur at a specific frequency. | Adjust the output frequency to avoid a resonance area. |
| The motor rotation is different from the setting. | The V/F pattern is set incorrectly. | Set a V/F pattern that is suitable for the motor specification. |
| The motor deceleration time is too long even with Dynamic Braking (DB) resistor connected. | The deceleration time is set too long. | Change the setting accordingly. |
| | The motor torque is insufficient. | If motor parameters are normal, it is likely to be a motor capacity fault. Replace the motor with a model with increased capacity. |
| | The load is higher than the internal torque limit determined by the rated current of the inverter. | Replace the inverter with a model with increased capacity. |
| Operation is difficult in underload applications. | The carrier frequency is too high. | Reduce the carrier frequency. |
| | Over-excitation has occurred due to an inaccurate V/F setting at low speed. | Reduce the torque boost value to avoid over-excitation. |
| While the inverter is in operation, a control unit malfunctions or noise occurs. | Noise occurs due to switching inside the inverter. | Change the carrier frequency to the minimum value. |
| | | Install a micro surge filter in the inverter output. |

| Type | Cause | Remedy |
|--|--|---|
| When the inverter is operating, the earth leakage breaker is activated. | An earth leakage breaker will interrupt the supply if current flows to ground during inverter operation. | Connect the inverter to a ground terminal. |
| | | Check that the ground resistance is less than 100Ω for 200V inverters and less than 10Ω for 400V inverters. |
| | | Check the capacity of the earth leakage breaker and make the appropriate connection, based on the rated current of the inverter. |
| | | Lower the carrier frequency. |
| | | Make the cable length between the inverter and the motor as short as possible. |
| The motor vibrates severely and does not rotate normally. | Phase-to-phase voltage of 3-phase power source is not balanced. | Check the input voltage and balance the voltage. |
| | | Check and test the motor's insulation. |
| The motor makes humming, or loud noises. | Resonance occurs between the motor's natural frequency and the carrier frequency. | Slightly increase or decrease the carrier frequency. |
| | Resonance occurs between the motor's natural frequency and the inverter's output frequency. | Slightly increase or decrease the carrier frequency. Use the frequency jump function to avoid the frequency band where resonance occurs. |
| The motor vibrates/hunts. | The frequency input command is an external, analog command. | In situations of noise inflow on the analog input side that results in command interference, change the input filter time constant (In.07). |
| | The wiring length between the inverter and the motor is too long. | Ensure that the total cable length between the inverter and the motor is less than 200m (50m for motors rated 3.7 kW or lower). |
| The motor does not come to a complete stop when the inverter output stops. | It is difficult to decelerate sufficiently, because DC braking is not operating normally. | Adjust the DC braking parameter. |
| | | Increase the set value for the DC braking current. |
| | | Increase the set value for the DC braking stopping time. |
| The output frequency does | The frequency reference is within the jump frequency range. | Set the frequency reference higher than the jump frequency range. |

| Type | Cause | Remedy |
|--|--|---|
| not increase to the frequency reference. | The frequency reference is exceeding the upper limit of the frequency command. | Set the upper limit of the frequency command higher than the frequency reference. |
| | Because the load is too heavy, the stall prevention function is working. | Replace the inverter with a model with increased capacity. |
| The cooling fan does not rotate. | The control parameter for the cooling fan is set incorrectly. | Check the control parameter setting for the cooling fan. |

10 Maintenance

This chapter explains how to replace the cooling fan, the regular inspections to complete, and how to store and dispose of the product. An inverter is vulnerable to environmental conditions and faults also occur due to component wear and tear. To prevent breakdowns, please follow the maintenance recommendations in this section.

⚠ Caution

- Before you inspect the product, read all safety instructions contained in this manual.
- Before you clean the product, ensure that the power is off.
- Clean the inverter with a dry cloth. Cleaning with wet cloths, water, solvents, or detergents may result in electric shock or damage to the product.

10.1 Regular Inspection Lists

10.1.1 Daily Inspections

| Inspection area | Inspection item | Inspection details | Inspection method | Judgment standard | Inspection equipment |
|-----------------|---------------------|--|--|--|-----------------------------------|
| All | Ambient environment | Is the ambient temperature and humidity within the design range, and is there any dust or foreign objects present? | Refer to 1.3 Installation Considerations on page 5 . | No icing (ambient temperature: -10 - +40) and no condensation (ambient humidity below 50%) | Thermometer, hygrometer, recorder |
| | Inverter | Is there any abnormal vibration or noise? | Visual inspection | No abnormality | |
| | Power voltage | Are the input and output voltages normal? | Measure voltages between R/ S/ T-phases in. the inverter terminal block. | Refer to 11.1 Input and Output Specification on page 341 . | Digital multimeter tester |

| Inspection area | Inspection item | Inspection details | Inspection method | Judgment standard | Inspection equipment |
|----------------------|---------------------|---|---|------------------------------------|--------------------------|
| Input/Output circuit | Smoothing capacitor | Is there any leakage from the inside? | Visual inspection | No abnormality | - |
| | | Is the capacitor swollen? | | | |
| Cooling system | Cooling fan | Is there any abnormal vibration or noise? | Turn off the system and check operation by rotating the fan manually. | Fan rotates smoothly | - |
| Display | Measuring device | Is the display value normal? | Check the display value on the panel. | Check and manage specified values. | Voltmeter, ammeter, etc. |
| Motor | All | Is there any abnormal vibration or noise? | Visual inspection | No abnormality | - |
| | | Is there any abnormal smell? | Check for overheating or damage. | | |

10.1.2 Annual Inspections

| Inspection area | Inspection item | Inspection details | Inspection method | Judgment standard | Inspection equipment |
|----------------------|-----------------|---|---|--------------------|----------------------|
| Input/Output circuit | All | Megger test (between input/output terminals and and earth terminal) | Disconnect inverter and short R/S/T/U/V/W terminals, and then measure from each terminal to the ground terminal using a Megger. | Must be above 5 MΩ | DC 500 V Megger |
| | | Is there anything loose in the device? | Tighten up all screws. | No abnormality | |
| | | Is there any evidence of | Visual inspection | | |

| Inspection area | Inspection item | Inspection details | Inspection method | Judgment standard | Inspection equipment |
|---|------------------------------------|---|--|---|--|
| | | parts overheating? | | | |
| | Cable connections | Are there any corroded cables? | Visual inspection | No abnormality | - |
| | | Is there any damage to cable insulation? | | | |
| | Terminal block | Is there any damage? | Visual inspection | No abnormality | - |
| | Smoothing condenser | Measure electrostatic capacity. | Measure with capacity meter. | Rated capacity over 85% | Capacity meter |
| | Relay | Is there any chattering noise during operation? | Visual inspection | No abnormality | - |
| | | Is there any damage to the contacts? | Visual inspection | | |
| | Braking resistor | Is there any damage from resistance? | Visual inspection | No abnormality | Digital multimeter / anaog tester |
| | | Check for disconnection. | Disconnect one side and measure with a tester. | Must be within $\pm 10\%$ of the rated value of the resistor. | |
| | Control circuit Protection circuit | Operation check | Check for output voltage imbalance while the inverter is in operation. | Measure voltage between the inverter output terminal U/V/ W. | Balance the voltage between phases: within 4V for 200V series and within 8V for 400V series. |
| Is there an error in the display circuit after the sequence | | | Test the inverter ouput protection in both short and | The circuit must work according to the sequence. | |

| Inspection area | Inspection item | Inspection details | Inspection method | Judgment standard | Inspection equipment |
|-----------------|-----------------|---------------------------------|---|--|--------------------------|
| | | protection test? | open circuit conditions. | | |
| Cooling system | Cooling fan | Are any of the fan parts loose? | Check all connected parts and tighten all screws. | No abnormality | - |
| Display | Display device | Is the display value normal? | Check the command value on the display device. | Specified and managed values must match. | Voltmeter, Ammeter, etc. |

10.1.3 Bi-annual Inspections

| Inspection area | Inspection item | Inspection details | Inspection method | Judgment standard | Inspection equipment |
|-----------------|-----------------------|--|--|--------------------|----------------------|
| Motor | Insulation resistance | Megger test (between the input, output and earth terminals). | Disconnect the cables for terminals U/V/W and test the wiring. | Must be above 5 MΩ | DC 500 V Megger |

⚠ Caution

Do not run an insulation resistance test (Megger) on the control circuit as it may result in damage to the product.

10.2 Storage and Disposal

10.2.1 Storage

If you are not using the product for an extended period, store it in the following way:

- Store the product in the same environmental conditions as specified for operation (refer to [1.3 Installation Considerations](#) on page 5).
- When storing the product for a period longer than 3 months, store it between 10°C and 30°C,

to prevent depletion of the electrolytic capacitor.

- Do not expose the inverter to snow, rain, fog, or dust.
- Package the inverter in a way that prevents contact with moisture. Keep the moisture level below 70% in the package by including a desiccant, such as silica gel.

10.2.2 Disposal

When disposing of the product, categorize it as general industrial waste. Recyclable materials are included in the product, so recycle them whenever possible. The packing materials and all metal parts can be recycled. Although plastic can also be recycled, it can be incinerated under controlled conditions in some regions.

⚠ Caution

If the inverter has not been operated for a long time, capacitors lose their charging characteristics and are depleted. To prevent depletion, turn on the product once a year and allow the device to operate for 30-60 min. Run the device under no-load conditions.

11 Technical Specification

11.1 Input and Output Specification

Single Phase 200V (0.4-2.2 kW)

| Model □□□□S100-1□□□□□ | | | 0004 | 0008 | 0015 | 0022 | |
|--|----------------------|-------------|--|------------------------|-----------------------|-----------------------|--|
| Applied motor | Heavy load | HP | 0.5 | 1.0 | 2.0 | 3.0 | |
| | | kW | 0.4 | 0.75 | 1.5 | 2.2 | |
| | Normal load | HP | 1.0 | 2.0 | 3.0 | 5.0 | |
| | | kW | 0.75 | 1.5 | 2.2 | 3.7 | |
| Rated output | Rated capacity (kVA) | Heavy load | 1.0 | 1.9 | 3.0 | 4.2 | |
| | | Normal load | 1.2 | 2.3 | 3.8 | 4.6 | |
| | Rated current (A) | Heavy load | 2.5 | 5.0 | 8.0 | 11.0 | |
| | | Normal load | 3.1 | 6.0 | 9.6 | 12.0 | |
| | Output frequency | | 0-400 Hz (IM Sensorless: 0-120 Hz) | | | | |
| | Output voltage (V) | | 3-phase 200-240 V | | | | |
| Rated input | Working voltage (V) | | Single phase 200-240 V AC (-15% to +10%) | | | | |
| | Input frequency | | 50-60 Hz (±5%) | | | | |
| | Rated current (A) | Heavy load | 4.4 | 9.3 | 15.6 | 21.7 | |
| | | Normal load | 5.8 | 11.7 | 19.7 | 24.0 | |
| Weight (lb /kg) (Built-in EMC filter) | | | 2/0.9 (2.5/1.14) | 2.86/1.3 (3.9/1.76) | 3.3/1.5 (3.9/1.76) | 4.4/2.0 (4.9/2.22) | |

- The standard motor capacity is based on a standard 4-pole motor.
- The standard used for 200 V inverters is based on a 220 V supply voltage, and for 400V inverters is based on a 440 V supply voltage.
- The rated output current is limited based on the carrier frequency set at Cn.04.
- The output voltage becomes 20~40% lower during no-load operations to protect the inverter from the impact of the motor closing and opening (0.4~4.0kW models only).

3 Phase 200V (0.4-4 kW)

| Model □□□□S100-2□□□□□ | | | 0004 | 0008 | 0015 | 0022 | 0037 | 0040 |
|-----------------------|--|-------------------|---|-------|----------|---------|---------|---------|
| Applied motor | Heavy load | HP | 0.5 | 1.0 | 2.0 | 3.0 | 5.0 | 5.4 |
| | | kW | 0.4 | 0.75 | 1.5 | 2.2 | 3.7 | 4.0 |
| | Normal load | HP | 1.0 | 2.0 | 3.0 | 5.0 | 5.4 | 7.5 |
| | | kW | 0.75 | 1.5 | 2.2 | 3.7 | 4.0 | 5.5 |
| Rated output | Rated capacity (kVA) | Heavy load | 1.0 | 1.9 | 3.0 | 4.2 | 6.1 | 6.5 |
| | | Normal load | 1.2 | 2.3 | 3.8 | 4.6 | 6.9 | 6.9 |
| | Rated current [3-Phase input] (A) | Heavy load | 2.5 | 5.0 | 8.0 | 11.0 | 16.0 | 17.0 |
| | | Normal load | 3.1 | 6.0 | 9.6 | 12.0 | 18.0 | 18.0 |
| | Rated current [Single-Phase input] (A) | Heavy load | 1.5 | 2.8 | 4.6 | 6.1 | 8.8 | 9.3 |
| | | Normal load | 1.8 | 3.3 | 5.7 | 6.6 | 9.9 | 9.9 |
| | Output frequency | | 0-400 Hz (IM Sensorless: 0-120 Hz) | | | | | |
| Output voltage (V) | | 3-phase 200-240 V | | | | | | |
| Rated input | Working voltage (V) | | 3-phase 200-240 VAC (-15% to +10%) Single phase 240VAC(-5% to +10%) | | | | | |
| | Input frequency | | 50-60 Hz (±5%) (In case of single phase input, input frequency is only 60Hz(±5%).) | | | | | |
| | Rated current (A) | Heavy load | 2.2 | 4.9 | 8.4 | 11.8 | 17.5 | 18.5 |
| Normal load | | 3.0 | 6.3 | 10.8 | 13.1 | 19.4 | 19.4 | |
| Weight (lb /kg) | | | 2/0.9 | 2/0.9 | 2.86/1.3 | 3.3/1.5 | 4.4/2.0 | 4.4/2.0 |

- The standard motor capacity is based on a standard 4-pole motor.
- The standard used for 200 V inverters is based on a 220 V supply voltage, and for 400V inverters is based on a 440 V supply voltage.
- The rated output current is limited based on the carrier frequency set at Cn.04.
- The output voltage becomes 20~40% lower during no-load operations to protect the inverter from the impact of the motor closing and opening (0.4~4.0kW models only).

3 Phase 200V (5.5-15 kW)

| Model □□□□S100-2□□□□□ | | | 0055 | 0075 | 0110 | 0150 |
|--|--|----------------------|---|---------------------|----------------------|------|
| Applied motor | Heavy load | HP | 7.5 | 10 | 15 | 20 |
| | | kW | 5.5 | 7.5 | 11 | 15 |
| | Normal load | HP | 10 | 15 | 20 | 25 |
| | | kW | 7.5 | 11 | 15 | 18.5 |
| Rated output | Rated capacity (kVA) | Heavy load | 9.1 | 12.2 | 17.5 | 22.9 |
| | | Normal load | 11.4 | 15.2 | 21.3 | 26.3 |
| | Rated current [3-Phase input] (A) | Heavy load | 24.0 | 32.0 | 46.0 | 60.0 |
| | | Normal load | 30.0 | 40.0 | 56.0 | 69.0 |
| | Rated current [Single-Phase input] (A) | Heavy load | 13.0 | 18.0 | 26.0 | 33.0 |
| | | Normal load | 16.0 | 22.0 | 31.0 | 38.0 |
| | Output frequency | | 0-400 Hz (IM Sensorless : 0-120 Hz) | | | |
| Output voltage (V) | | 3 phase 200-240V | | | | |
| Rated input | Working voltage (V) | | 3 phase 200-240VAC (-15% to +10%) Single phase 240VAC(-5% to +10%) | | | |
| | Input frequency | | 50-60 Hz (±5%) (In case of single phase input, input frequency is only 60Hz(±5%.)) | | | |
| | Rated current (A) | Heavy load | 25.8 | 34.9 | 50.8 | 66.7 |
| Normal load | | 32.7 | 44.2 | 62.3 | 77.2 | |
| Weight (lb /kg) (Non EMC Filter type) | | 7.3/3.3 (6.8/3.1) | 7.3/3.3 (6.8/3.1) | 10/4.6 (9.7/4.4) | 16/7.1 (15.2/6.9) | |

- The standard motor capacity is based on a standard 4-pole motor
- The standard used for 200 V inverters is based on a 220 V supply voltage, and for 400V inverters is based on a 440 V supply voltage.
- The rated output current is limited based on the carrier frequency set at Cn.04.

3-Phase 400V (0.4-4 kW)

| Model □□□□S100-4□□□□□ | | | 0004 | 0008 | 0015 | 0022 | 0037 | 0040 |
|--|--|---|--|---------------------|------------------------|---------------------|-----------------------|-----------------------|
| Applied motor | Heavy load | HP | 0.5 | 1.0 | 2.0 | 3.0 | 5.0 | 5.4 |
| | | kW | 0.4 | 0.75 | 1.5 | 2.2 | 3.7 | 4.0 |
| | Normal load | HP | 1.0 | 2.0 | 3.0 | 5.0 | 5.4 | 7.5 |
| | | kW | 0.75 | 1.5 | 2.2 | 3.7 | 4.0 | 5.5 |
| Rated output | Rated capacity (kVA) | Heavy load | 1.0 | 1.9 | 3.0 | 4.2 | 6.1 | 6.5 |
| | | Normal load | 1.5 | 2.4 | 3.9 | 5.3 | 7.6 | 7.6 |
| | Rated current [3-Phase input] (A) | Heavy load | 1.3 | 2.5 | 4.0 | 5.5 | 8.0 | 9.0 |
| | | Normal load | 2.0 | 3.1 | 5.1 | 6.9 | 10.0 | 10.0 |
| | Rated current [Single-Phase input] (A) | Heavy load | 0.8 | 1.5 | 2.3 | 3.1 | 4.8 | 5.4 |
| | | Normal load | 1.3 | 1.9 | 3.0 | 3.9 | 5.9 | 5.9 |
| | Output frequency | | 0-400 Hz (IM Sensorless: 0-120 Hz) | | | | | |
| Output voltage (V) | | 3-phase 380-480VAC (-15% to +10%) Single phase 480VAC(-5% to +10%) | | | | | | |
| Rated input | Working voltage (V) | | 50-60 Hz (±5%) (In case of single phase input, input frequency is only 60Hz(±5%.) | | | | | |
| | Input frequency | | 50-60 Hz (±5%) | | | | | |
| | Rated current (A) | Heavy load | 1.1 | 2.4 | 4.2 | 5.9 | 8.7 | 9.8 |
| Normal load | | 2.0 | 3.3 | 5.5 | 7.5 | 10.8 | 10.8 | |
| Weight (lb /kg) (Built-in EMC filter) | | | 2/0.9 (2.6/1.18) | 2/0.9 (2.6/1.18) | 2.86/1.3 (3.9/1.77) | 3.3/1.5 (4/1.80) | 4.4/2.0 (4.9/2.23) | 4.4/2.0 (4.9/2.23) |

- The standard motor capacity is based on a standard 4-pole motor.
- The standard used for 200 V inverters is based on a 220 V supply voltage, and for 400V inverters is based on a 440 V supply voltage.
- The rated output current is limited based on the carrier frequency set at Cn.04.
- The output voltage becomes 20~40% lower during no-load operations to protect the inverter from the impact of the motor closing and opening (0.4~4.0kW models only).
- 0.4~4.0kW(built-in EMC filter) do not support single phase input.

3-Phase 400V (5.5-22 kW)

| Model □□□□S100-4□□□□□ | | | 0055 | 0075 | 0110 | 0150 | 0185 | 0220 | |
|--|--|-------------|---|--------------------|-----------------------|------------------------|----------------------|----------------------|--|
| Applied motor | Heavy load | HP | 7.5 | 10 | 15 | 20 | 25 | 30 | |
| | | kW | 5.5 | 7.5 | 11 | 15 | 18.5 | 22 | |
| | Normal load | HP | 10 | 15 | 20 | 25 | 30 | 40 | |
| | | kW | 7.5 | 11 | 15 | 18.5 | 22 | 30 | |
| Rated output | Rated capacity (kVA) | Heavy load | 9.1 | 12.2 | 18.3 | 22.9 | 29.7 | 34.3 | |
| | | Normal load | 12.2 | 17.5 | 22.9 | 29.0 | 33.5 | 44.2 | |
| | Rated current [3-Phase input] (A) | Heavy load | 12.0 | 16.0 | 24.0 | 30.0 | 39.0 | 45.0 | |
| | | Normal load | 16.0 | 23.0 | 30.0 | 38.0 | 44.0 | 58.0 | |
| | Rated current [Single-Phase input] (A) | Heavy load | 7.1 | 9.5 | 15.0 | 18.0 | 23.0 | 27.0 | |
| | | Normal load | 9.5 | 14.0 | 18.0 | 23.0 | 27.0 | 35.0 | |
| | Output frequency | | 0-400 Hz (IM Sensorless: 0-120 Hz) | | | | | | |
| | Output voltage (V) | | 3-phase 380-480V | | | | | | |
| Rated input | Working voltage (V) | | 3-phase 380-480VAC (-15% to +10%) Single phase 480VAC(-5% to +10%) | | | | | | |
| | Input frequency | | 50-60 Hz (±5%) (In case of single phase input, input frequency is only 60Hz(±5%).) | | | | | | |
| | Rated current (A) | Heavy load | 12.9 | 17.5 | 26.5 | 33.4 | 43.6 | 50.7 | |
| Normal load | | 17.5 | 25.4 | 33.4 | 42.5 | 49.5 | 65.7 | | |
| Weight (lb /kg) (Non EMC Filter type) | | | 7.3/3.3 (6.8/3.1) | 7.5/3.4 (7/3.2) | 10.1/4.6 (9.7/4.4) | 10.5/4.8 (10.1/4.6) | 16.5/7.5 (16/7.3) | 16.5/7.5 (16/7.3) | |

- The standard motor capacity is based on a standard 4-pole motor.
- The standard used for 200 V inverters is based on a 220 V supply voltage, and for 400V inverters is based on a 440 V supply voltage.
- The rated output current is limited, based on the carrier frequency set at Cn.04.

Note

Precautions for 1-phase input to 3-phase drive

- Please connect single-phase input to R(L1) and T(L3).
- AC or DC reactor is necessary to reduce DC ripple. Please select built-in reactor type for 30~75kW. For 0.4~22kW, external AC or DC reactor should be installed.
- Same peripheral devices (including a fuse and reactor) as 3-phase can be used for 1-phase as well.
- If phase open trip occurs, please turn off the input phase open protection(PR-05).
- Protection for output current like OCT or IOLT is based on 3-phase input ratings which is larger than single-phase input. User should set the parameters that are relative to motor information(bA-11~16), overload trip(Pr-17~22) and E-thermal functions(Pr-40~43)
- Performance of sensorless control could be unstable depending on DC ripple.
- The minimum input voltage must be larger than 228Vac for 240Vac supply and 456Vac for 480Vac supply to ensure motor voltage production of 207Vac and 415Vac, respectively.
- To minimize the effect of voltage deprivation, please choose 208Vac motor for 240Vac supply and 400Vac motor for 480Vac supply.

11.2 Product Specification Details

| Items | | Description | | | | | |
|-------------------------------------|--|---|-------------------------------------|--|---|-------------|--|
| Control | Control method | V/F control, slip compensation, sensorless vector | | | | | |
| | Frequency settings power resolution | Digital command: 0.01 Hz Analog command: 0.06 Hz (60 Hz standard) | | | | | |
| | Frequency accuracy | 1% of maximum output frequency | | | | | |
| | V/F pattern | Linear, square reduction, user V/F | | | | | |
| | Overload capacity | Heavy load rated current: 150% 1 min, normal load rated current: 120% 1 min | | | | | |
| | Torque boost | Manual torque boost, automatic torque boost | | | | | |
| Operation | Operation type | Select key pad, terminal strip, or communication operation | | | | | |
| | Frequency settings | Analog type: -10~10V, 0~10V, 4~20mA Digital type: key pad, pulse train input | | | | | |
| | Operation function | <ul style="list-style-type: none"> • PID control • 3-wire operation • Frequency limit • Second function • Anti-forward and reverse direction rotation • Commercial transition • Speed search • Power braking • Leakage reduction <ul style="list-style-type: none"> • Up-down operation • DC braking • Frequency jump • Slip compensation • Automatic restart • Automatic tuning • Energy buffering • Flux braking • Fire Mode | | | | | |
| | Input | <table border="1" style="width: 100%; border-collapse: collapse;"> <tr> <td style="width: 20%; vertical-align: top;"> Multi function terminal (7EA) P1-P7 </td> <td style="width: 60%; vertical-align: top;"> Select PNP (Source) or NPN (Sink) mode. Functions can be set according to In.65- In.71 codes and parameter settings. (Standard I/O is only provided for P5.) </td> <td style="width: 20%; vertical-align: top;"> <ul style="list-style-type: none"> • Reverse direction operation • External trip • Jog operation • Multi step acc/dec-high/med/low • Second motor selection • Frequency reduction • Fix analog command frequency • Transition from PID to general operation </td> </tr> <tr> <td style="vertical-align: top;">Pulse train</td> <td colspan="2" style="vertical-align: top;">0-32 kHz, Low Level: 0-0.8V, High Level: 3.5-12V</td> </tr> </table> | Multi function terminal (7EA) P1-P7 | Select PNP (Source) or NPN (Sink) mode. Functions can be set according to In.65- In.71 codes and parameter settings. (Standard I/O is only provided for P5.) | <ul style="list-style-type: none"> • Reverse direction operation • External trip • Jog operation • Multi step acc/dec-high/med/low • Second motor selection • Frequency reduction • Fix analog command frequency • Transition from PID to general operation | Pulse train | 0-32 kHz, Low Level: 0-0.8V, High Level: 3.5-12V |
| Multi function terminal (7EA) P1-P7 | Select PNP (Source) or NPN (Sink) mode. Functions can be set according to In.65- In.71 codes and parameter settings. (Standard I/O is only provided for P5.) | <ul style="list-style-type: none"> • Reverse direction operation • External trip • Jog operation • Multi step acc/dec-high/med/low • Second motor selection • Frequency reduction • Fix analog command frequency • Transition from PID to general operation | | | | | |
| Pulse train | 0-32 kHz, Low Level: 0-0.8V, High Level: 3.5-12V | | | | | | |

| Items | | | Description | |
|-------------------------------|------------------------|---|---|--|
| | Output | Multi function open collector terminal | Fault output and inverter operation status output | Less than DC 24V, 50mA |
| | | Multi function relay terminal | | Less than (N.O., N.C.) AC250V 1A, Less than DC 30V, 1A |
| | Analog output | 0-12Vdc (0-24mA): Select frequency, output current, output voltage, DC terminal voltage and others | | |
| | Pulse train | Maximum 32 kHz, 10-12V | | |
| Protection function | Trip | <ul style="list-style-type: none"> • Over current trip • External signal trip • ARM short circuit current trip • Over heat trip • Input imaging trip • Ground trip • Motor over heat trip • I/O board link trip • No motor trip • Parameter writing trip • Emergency stop trip • Command loss trip • External memory error • CPU watchdog trip • Motor normal load trip <ul style="list-style-type: none"> • Over voltage trip • Temperature sensor trip • Inverter over heat • Option trip • Output imaging trip • Inverter overload trip • Fan trip • Pre-PID operation failure • External break trip • Low voltage trip during operation • Low voltage trip • Safety A(B) trip • Analog input error • Motor overload trip | | |
| | Alarm | Command loss trip alarm, overload alarm, normal load alarm, inverter overload alarm, fan operation alarm, resistance braking rate alarm, number of corrections on rotor tuning error | | |
| | Instantaneous blackout | Heavy load less than 15 ms (normal load less than 8 ms): continue operation (must be within the rated input voltage and rated output range) Heavy load more than 15 ms (normal load more than 8 ms): auto restart operation | | |
| Structure/working environment | Cooling type | Forced fan cooling structure Forced cooling type: 0.4-15 kW 200V/0.4-22 kW 400V (excluding some models) | | |
| | Protection structure | IP 20 , UL Open Type (UL Enclosed Type 1 is satisfied by conduit installation option.) | | |
| | Ambient temperature | Heavy load: -10-50°C (14-122°F), normal load: -10-40°C (14- | | |

| Items | | Description |
|-------|--------------------------------|--|
| | | 104°F) No ice or frost should be present. Working under normal load at 50°C (122°F), it is recommended that less than 80% load is applied. |
| | Ambient humidity | Relative humidity less than 90% RH (to avoid condensation forming) |
| | Storage temperature. | -20°C-65°C (-4-149°F) |
| | Surrounding environment | Prevent contact with corrosive gases, inflammable gases, oil stains, dust, and other pollutants (Pollution Degree 3 Environment). |
| | Operation altitude/oscillation | No higher than 3280ft (1,000m). Less than 9.8m/sec ² (1G). |
| | Pressure | 70-106 kPa |

11.3 External Dimensions (IP 20 Type)

0.4 kW (Single Phase), 0.4-0.8 kW (3-Phase)

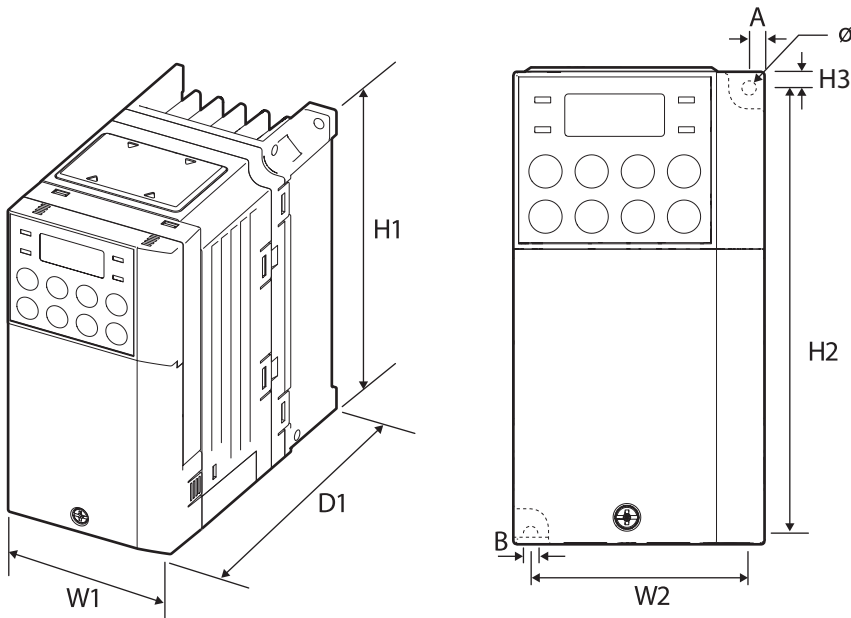

Specification

0.8kW~1.5kW(Single Phase 200V), 1.5kW~2.2kW(3-Phase 400V) EMC filter Type

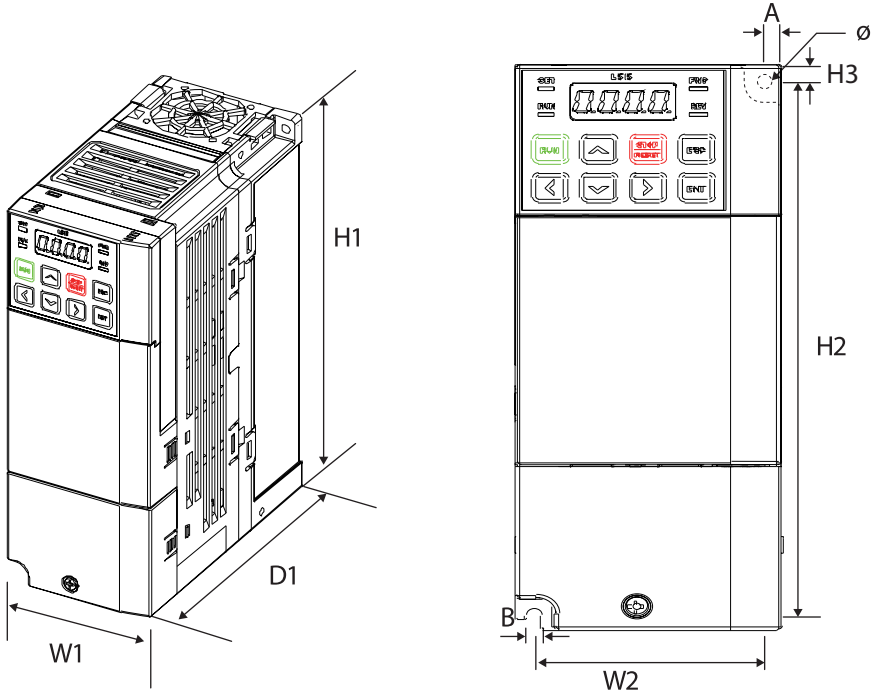

| Items | W1 | W2 | H1 | H2 | H3 | D1 | A | B | Φ |
|---|--------------|----------------|---------------|-----------------|-------------|---------------|---------------|---------------|---------------|
| 0004S100-1, 0008S100-2, 0008S100-4 | 68 (2.68) | 61.1 (2.41) | 128 (5.04) | 119 (4.69) | 5 (0.20) | 128 (5.04) | 3.5 (0.14) | 4 (0.16) | 4 (0.16) |
| 0004S100-2, 0004S100-4 | 68 (2.68) | 61.1 (2.41) | 128 (5.04) | 119 (4.69) | 5 (0.20) | 123 (4.84) | 3.5 (0.14) | 4 (0.16) | 4.2 (0.17) |
| 004S100-1, 004S100-4, 008S100-4 EMC Type | 68 (2.68) | 63.5 (2.50) | 180 (7.09) | 170.5 (6.71) | 5 (0.20) | 130 (5.12) | 4.5 (0.18) | 4.5 (0.18) | 4.2 (0.17) |

Units: mm (inches)

0.8-1.5 kW (Single Phase), 1.5-2.2 kW(3-Phase)

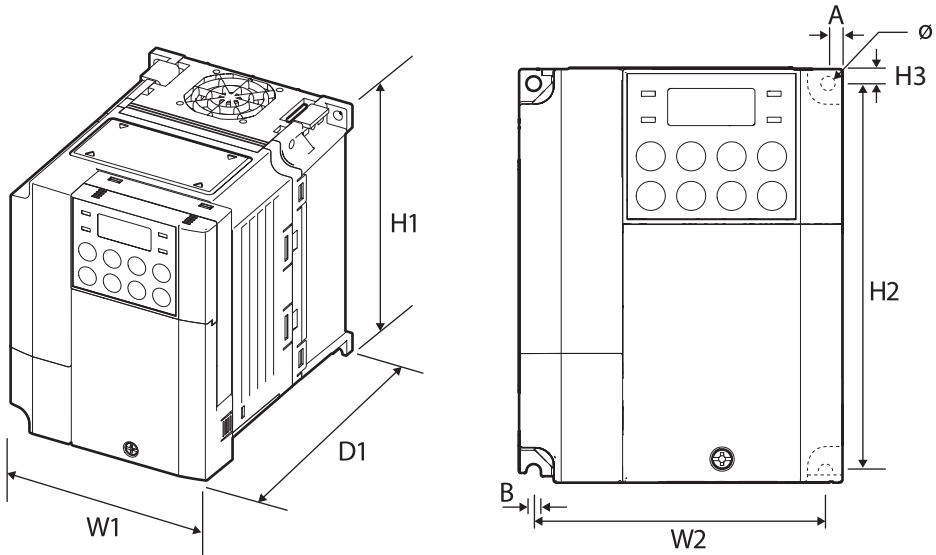

0.8kW~1.5kW(Single Phase 200V), 1.5kW~2.2kW(3-Phase 400V) EMC filter Type

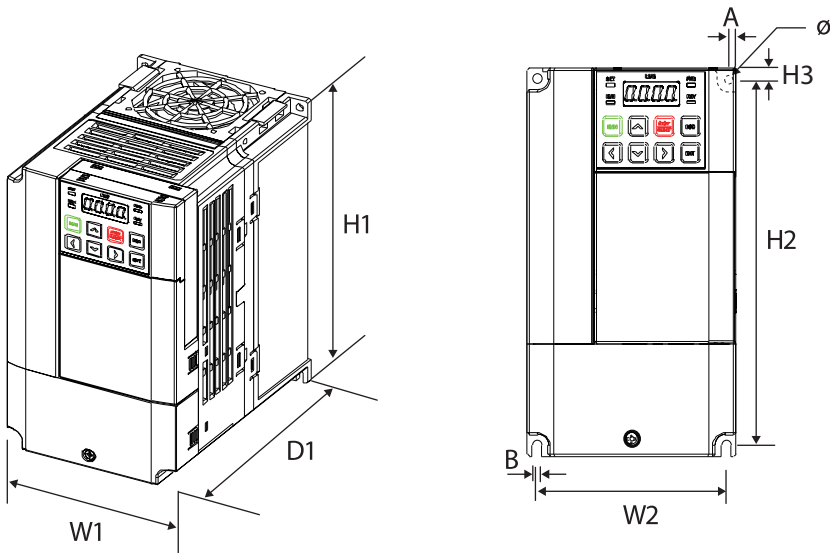

| Items | W1 | W2 | H1 | H2 | H3 | D1 | A | B | Φ |
|--|---------------|--------------|---------------|---------------|---------------|---------------|---------------|---------------|---------------|
| 0008S100-1, 0015S100-2, 0015S100-4 | 100 (3.94) | 91 (3.58) | 128 (5.04) | 120 (4.72) | 4.5 (0.18) | 130 (5.12) | 4.5 (0.18) | 4.5 (0.18) | 4.5 (0.18) |

Technical Specification

| Items | W1 | W2 | H1 | H2 | H3 | D1 | A | B | Φ |
|--|---------------|--------------|---------------|---------------|---------------|---------------|---------------|---------------|---------------|
| 0015S100-1, 0022S100-2, 0022S100-4 | 100 (3.94) | 91 (3.58) | 128 (5.04) | 120 (4.72) | 4.5 (0.18) | 145 (5.71) | 4.5 (0.18) | 4.5 (0.18) | 4.5 (0.18) |
| 0008S100-1, 0015S100-1, 0015S100-4, 0022S100-4 EMCType | 100 (3.94) | 91 (3.58) | 180 (7.09) | 170 (6.69) | 5 (0.20) | 140 (5.51) | 4.5 (0.18) | 4.5 (0.18) | 4.2 (0.17) |

Units: mm (inches)

2.2 kW (Single Phase), 3.7-4.0 kW (3 Phase)

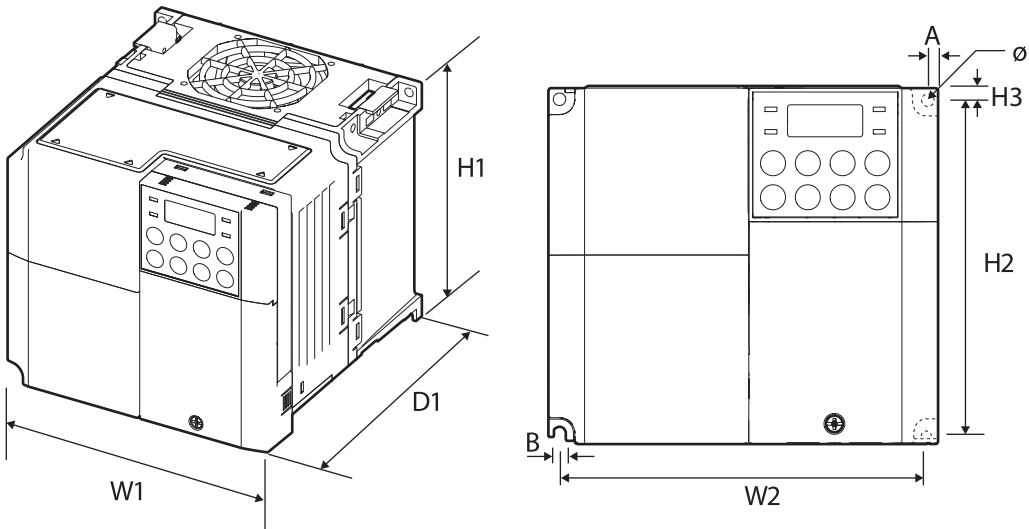

2.2kW(Single Phase 200V), 3.7~4.0kW(3-Phase 400V) EMC filter Type

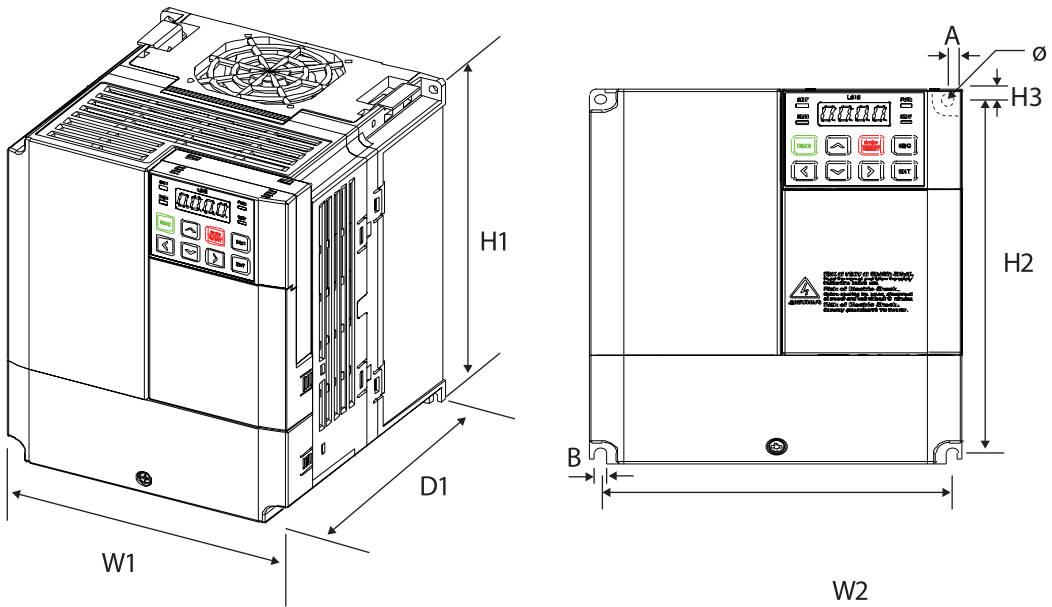

| Items | W1 | W2 | H1 | H2 | H3 | D1 | A | B | Ø |
|--|---------------|-----------------|---------------|-----------------|---------------|---------------|---------------|---------------|---------------|
| 0022S100-1 0037S100-2 0040S100-2 0037S100-4 0040S100-4 | 140 (5.51) | 132.2 (5.20) | 128 (5.04) | 120.7 (4.75) | 3.7 (0.15) | 145 (5.71) | 3.9 (0.15) | 4.4 (0.17) | 4.5 (0.18) |
| 0022S100-1, 0037S100-4, 0040S100-4 EMCType | 140 (5.51) | 132 (5.20) | 180 (7.09) | 170 (6.69) | 5 (0.20) | 140 (5.51) | 4 (0.16) | 4 (0.16) | 4.2 (0.17) |

Units: mm (inches)

5.5-22 kW (3-Phase)

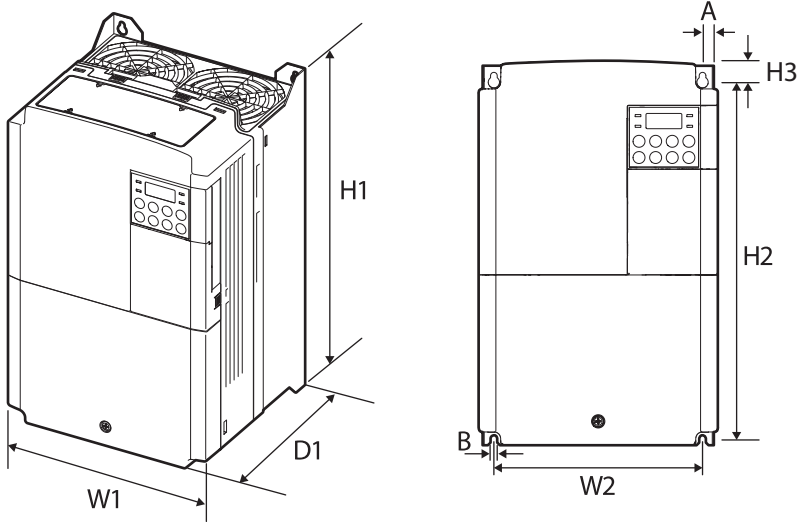

| Items | | W1 | W2 | H1 | H2 | H3 | D1 | A | B | Ø |
|-----------------|------------|--------|--------|--------|--------|--------|--------|--------|--------|---|
| 3-phase 200V | 0055S100-2 | 160 | 137 | 232 | 216.5 | 10.5 | 140 | 5 | 5 | - |
| | 0075S100-2 | (6.30) | (5.39) | (9.13) | (8.52) | (0.41) | (5.51) | (0.20) | (0.20) | - |
| | 0110S100-2 | 180 | 157 | 290 | 273.7 | 11.3 | 163 | 5 | 5 | - |
| | 0150S100-2 | (7.09) | (6.18) | (11.4) | (10.8) | (0.44) | (6.42) | (0.20) | (0.20) | - |
| 3-phase 400V | 0150S100-2 | 220 | 193.8 | 350 | 331 | 13 | 187 | 6 | 6 | - |
| | | (8.66) | (7.63) | (13.8) | (13.0) | (0.51) | (7.36) | (0.24) | (0.24) | - |
| | 0055S100-4 | 160 | 137 | 232 | 216.5 | 10.5 | 140 | 5 | 5 | - |
| | 0075S100-4 | (6.30) | (5.39) | (9.13) | (8.52) | (0.41) | (5.51) | (0.20) | (0.20) | - |
| | 0110S100-4 | 180 | 157 | 290 | 273.7 | 11.3 | 163 | 5 | 5 | - |
| | 0150S100-4 | (7.09) | (6.18) | (11.4) | (10.8) | (0.44) | (6.42) | (0.20) | (0.20) | - |
| 0185S100-4 | 220 | 193.8 | 350 | 331 | 13 | 187 | 6 | 6 | - | |
| 0220S100-4 | (8.66) | (7.63) | (13.8) | (13.0) | (0.51) | (7.36) | (0.24) | (0.24) | - | |

Units: mm (inches)

11.4 Peripheral Devices

Compatible Circuit Breaker, Leakage Breaker and Magnetic Contactor Models (manufactured by LSIS)

| Product (kW) | | Circuit Breaker | | | | Leakage Breaker | | Magnetic Contactor | | | | | | |
|----------------------|------|-----------------|-------------|--------|-------------|-----------------|-------------|--------------------|-------------|--------|-------------------|---|---------|----|
| | | Model | Current (A) | Model | Current (A) | Model | Current (A) | Model | Current (A) | | | | | |
| Single phase 200V | 0.4 | ABS33c | 5 | UTE100 | 15 | EBS33c | 5 | MC-6a | 9 | | | | | |
| | 0.75 | | 10 | | | | 10 | MC-9a, MC-9B | 11 | | | | | |
| | 1.5 | | 15 | | | | 15 | MC-18a, MC-18B | 18 | | | | | |
| | 2.2 | | 20 | | | | 20 | MC-22b | 22 | | | | | |
| 3-phase 200V | 0.4 | ABS33c | 5 | UTE100 | 15 | EBS33c | 5 | MC-6a | 9 | | | | | |
| | 0.75 | | 10 | | | | 10 | MC-9a, MC-9b | 11 | | | | | |
| | 1.5 | | 15 | | | | 15 | MC-18a, MC-18b | 18 | | | | | |
| | 2.2 | | 20 | | | | 20 | MC-22b | 22 | | | | | |
| | 3.7 | | 30 | | | | 30 | 30 | 30 | MC-32a | 32 | | | |
| | 4 | | | | | | | | | | | | | |
| | 5.5 | ABS53c | 50 | 50 | EBS53c | 50 | MC-50a | 55 | | | | | | |
| | 7.5 | ABS63c | 60 | 60 | EBS63c | 60 | MC-65a | 65 | | | | | | |
| | 11 | ABS103c | 100 | 90 | EBS103c | 100 | MC-85a | 85 | | | | | | |
| | 15 | | 125 | UTS150 | | 125 | 125 | MC-130a | 130 | | | | | |
| 3-phase 400V | 0.4 | ABS33c | 3 | UTE100 | 15 | EBS33c | 5 | MC-6a | 7 | | | | | |
| | 0.75 | | 5 | | | | | MC-6a | | | | | | |
| | 1.5 | | 10 | | | | 10 | 10 | 10 | 10 | MC-9a, MC-9b | 9 | | |
| | 2.2 | | | | | | | | | | MC-12a, MC-12b | | | |
| | 3.7 | | | | | | | | | | 15 | | MC-18a, | 18 |
| | 4 | | | | | | | | | | 20 | | MC-18b | |
| | 5.5 | 30 | 30 | 30 | 30 | 30 | MC-22b | 22 | | | | | | |
| | 7.5 | | | | | | MC-32a | | 32 | | | | | |
| | 11 | ABS53c | 50 | 50 | EBS53c | 50 | MC-50a | 50 | | | | | | |
| | 15 | ABS63c | 60 | 60 | EBS63c | 60 | MC-65a | 65 | | | | | | |
| | 18.5 | ABS103c | 75 | 80 | EBS103c | 75 | MC-75a | 75 | | | | | | |
| | 22 | | 100 | 90 | | 100 | 100 | MC-85a | 85 | | | | | |

11.5 Fuse and Reactor Specifications

| Product (kW) | | AC Input Fuse | | AC Reactor | | DC Reactor | |
|----------------------|------|---------------|-------------|-----------------|------------|-----------------|-------------|
| | | Current (A) | Voltage (V) | Inductance (mH) | Current(A) | Inductance (mH) | Current (A) |
| Single phase 200V | 0.4 | 10 | 600 | 1.20 | 10 | 4 | 8.67 |
| | 0.75 | | | | | | |
| | 1.5 | 15 | | 0.88 | 14 | 3 | 13.05 |
| | 2.2 | 20 | | 0.56 | 20 | 1.3 | 18.45 |
| 3-phase 200V | 0.4 | 10 | | 1.20 | 10 | 4 | 8.67 |
| | 0.75 | | | | | | |
| | 1.5 | 15 | | 0.88 | 14 | 3 | 13.05 |
| | 2.2 | 20 | | 0.56 | 20 | 1.33 | 18.45 |
| | 3.7 | 32 | | 0.39 | 30 | | 26.35 |
| | 4 | 50 | | | | | |
| | 5.5 | 50 | | 0.30 | 34 | 1.60 | 32 |
| | 7.5 | 63 | | 0.22 | 45 | 1.25 | 43 |
| | 11 | 80 | 0.16 | 64 | 0.95 | 61 | |
| | 15 | 100 | 0.13 | 79 | 0.70 | 75 | |
| 3-phase 400V | 0.4 | 10 | 4.81 | 4.8 | 16 | 4.27 | |
| | 0.75 | | | | | | |
| | 1.5 | | 3.23 | 7.5 | 12 | 6.41 | |
| | 2.2 | 15 | 2.34 | 10 | 8 | 8.9 | |
| | 3.7 | 20 | 1.22 | 15 | 5.4 | 13.2 | |
| | 4 | 32 | | | | | |
| | 5.5 | | 1.12 | 19 | 3.20 | 17 | |
| | 7.5 | 35 | 0.78 | 27 | 2.50 | 25 | |
| | 11 | 50 | 0.59 | 35 | 1.90 | 32 | |
| | 15 | 63 | 0.46 | 44 | 1.40 | 41 | |
| | 18.5 | 70 | 0.40 | 52 | 1.00 | 49 | |
| | 22 | 100 | 0.30 | 68 | 0.70 | 64 | |

⚠ Caution

Only use Class H or RK5, UL listed input fuses and UL listed circuit breakers. See the table above for the voltage and current ratings for fuses and circuit breakers.

⚠ Attention

Utiliser UNIQUEMENT des fusibles d'entrée homologués de Classe H ou RK5 UL et des disjoncteurs UL. Se reporter au tableau ci-dessus pour la tension et le courant nominal des fusibles et des disjoncteurs.

11.6 Terminal Screw Specification

Input/Output Terminal Screw Specification

| Product (kW) | | Terminal Screw Size | Screw Torque (Kgf·cm/Nm) |
|----------------------|------|---------------------|--------------------------|
| Single phase 200V | 0.4 | M3.5 | 2.1-6.1/0.2-0.6 |
| | 0.75 | | |
| | 1.5 | | |
| | 2.2 | M4 | |
| 3-phase 200V | 0.4 | M3.5 | 4.0-10.2/0.4-1.0 |
| | 0.75 | | |
| | 1.5 | | |
| | 2.2 | | |
| | 3.7 | M4 | |
| | 4 | | |
| | 5.5 | | |
| | 7.5 | M5 | |
| | 11 | | |
| | 15 | | |
| 3-phase 400V | 0.4 | M3.5 | 4.0-10.2/0.4-1.0 |
| | 0.75 | | |
| | 1.5 | | |
| | 2.2 | | |
| | 3.7 | M4 | |
| | 4 | | |
| | 5.5 | | |
| | 7.5 | M5 | |
| | 11 | | |
| | 15 | | |
| | 18.5 | M5 | 4.0-10.2/0.4-1.0 |
| | 22 | | |

Control Circuit Terminal Screw Specification

| Terminal | Terminal Screw Size | Screw Torque (Kgf·cm/Nm) |
|--|---------------------|--------------------------|
| P1-P7/ CM/VR/V1/I2/AO/Q1/EG/24/TI /TO/ SA,SB,SC/S+,S-,SG | M2 | 2.2-2.5/0.22-0.25 |
| A1/B1/C1 | M2.6 | 4.0/0.4 |

* Standard I/O doesn't support P6/P7/TI/TO terminal. Refer to [Step 4 Control Terminal Wiring](#) on page [27](#).

⚠ Caution

Apply the rated torque when tightening terminal screws. Loose screws may cause short circuits and malfunctions. Overtightening terminal screws may damage the terminals and cause short circuits and malfunctions. Use copper conductors only, rated at 600V, 75°C for power terminal wiring, and rated at 300V, 75°C for control terminal wiring.

⚠ Attention

Appliquer des couples de marche aux vis des bornes. Des vis desserrées peuvent provoquer des courts-circuits et des dysfonctionnements. Ne pas trop serrer la vis, car cela risque d'endommager les bornes et de provoquer des courts-circuits et des dysfonctionnements. Utiliser uniquement des fils de cuivre avec une valeur nominale de 600 V, 75 °C pour le câblage de la borne d'alimentation, et une valeur nominale de 300 V, 75 °C pour le câblage de la borne de commande.

11.7 Braking Resistor Specification

| Product (kW) | | Resistance (Ω) | Rated Capacity (W) |
|----------------------|------|-------------------------|--------------------|
| Single phase 200V | 0.4 | 300 | 100 |
| | 0.75 | 150 | 150 |
| | 1.5 | 60 | 300 |
| | 2.2 | 50 | 400 |
| 3-phase 200V | 0.4 | 300 | 100 |
| | 0.75 | 150 | 150 |
| | 1.5 | 60 | 300 |
| | 2.2 | 50 | 400 |
| | 3.7 | 33 | 600 |
| | 4 | 33 | 600 |
| | 5.5 | 20 | 800 |
| | 7.5 | 15 | 1,200 |
| | 11 | 10 | 2,400 |
| 15 | 8 | 2,400 | |
| 3-phase 400V | 0.4 | 1,200 | 100 |
| | 0.75 | 600 | 150 |
| | 1.5 | 300 | 300 |
| | 2.2 | 200 | 400 |
| | 3.7 | 130 | 600 |
| | 4 | 130 | 600 |
| | 5.5 | 85 | 1,000 |
| | 7.5 | 60 | 1,200 |
| | 11 | 40 | 2,000 |
| | 15 | 30 | 2,400 |
| | 18.5 | 20 | 3,600 |
| | 22 | 20 | 3,600 |

- The standard for braking torque is 150% and the working rate (%ED) is 5%. If the working rate is 10%, the rated capacity for braking resistance must be calculated at twice the standard.

11.8 Continuous Rated Current Derating

Derating by Carrier Frequency

The continuous rated current of the inverter is limited based on the carrier frequency. Refer to the following graph.

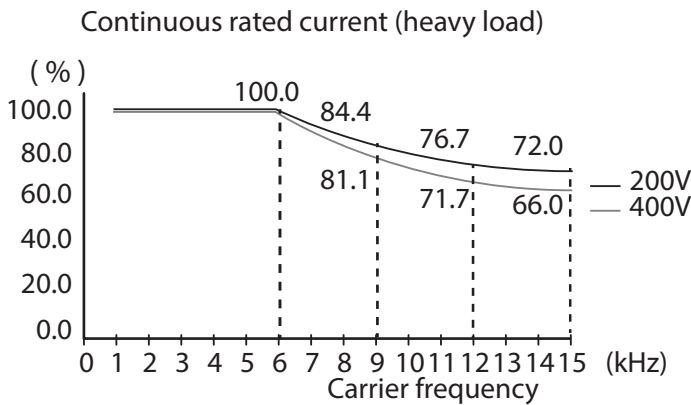

| 200V | | 400V | |
|-------------------------|----------------------------|-------------------------|----------------------------|
| Carrier Frequency (kHz) | Constant-rated Current (%) | Carrier Frequency (kHz) | Constant-rated Current (%) |
| 1-6 | 100 | 1-6 | 100 |
| 9 | 84.4 | 9 | 81.1 |
| 12 | 76.7 | 12 | 71.7 |
| 15 | 72.0 | 15 | 66.0 |

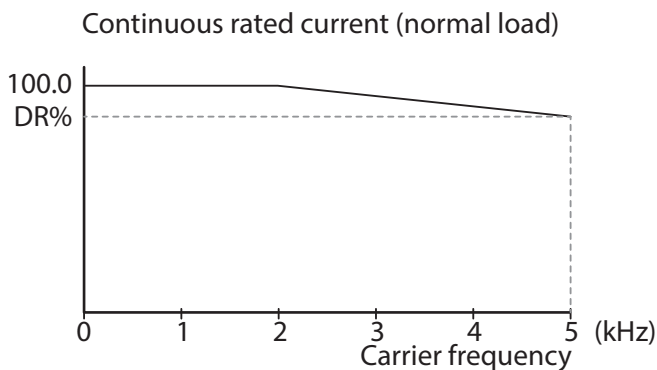

| 200V | | 400V | |
|--------------|--------|--------------|--------|
| Product (kW) | DR (%) | Product (kW) | DR (%) |
| 5.5 | 85 | 5.5 | 81.3 |
| 7.5 | 85 | 7.5 | 77.2 |
| 11 | 86.6 | 11 | 85 |
| 15 | 90.2 | 15 | 84.2 |
| | | 18.5 | 91.5 |
| | | 22 | 83.2 |

Derating by Input Voltage

The continuous rated current of the inverter is limited based on the input voltage. Refer to the following graph.

Continuous rated current (200V)

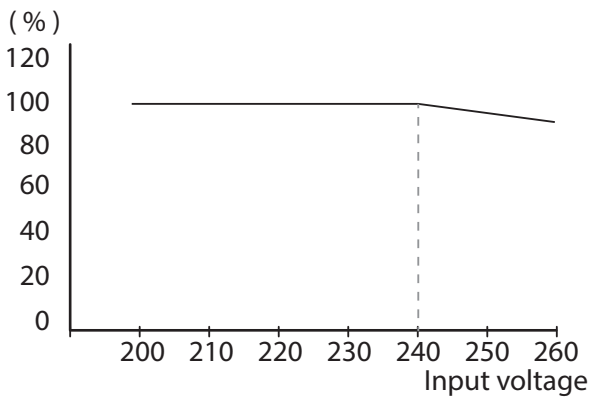

Continuous rated current (400V)

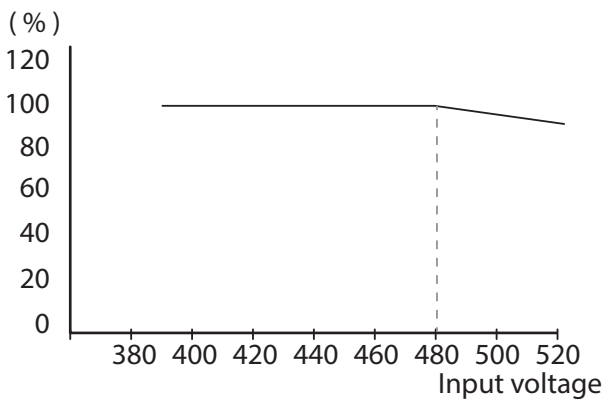

Derating by Ambient Temperature and Installation Type

The constant-rated current of the inverter is limited based on the ambient temperature and installation type. Refer to the following graph.

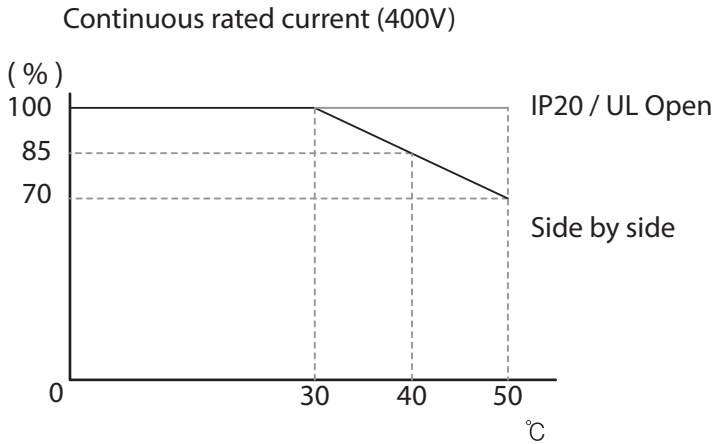

11.9 Heat Emmission

The following graph shows the inverters' heat emission characteristics (by product capacity).

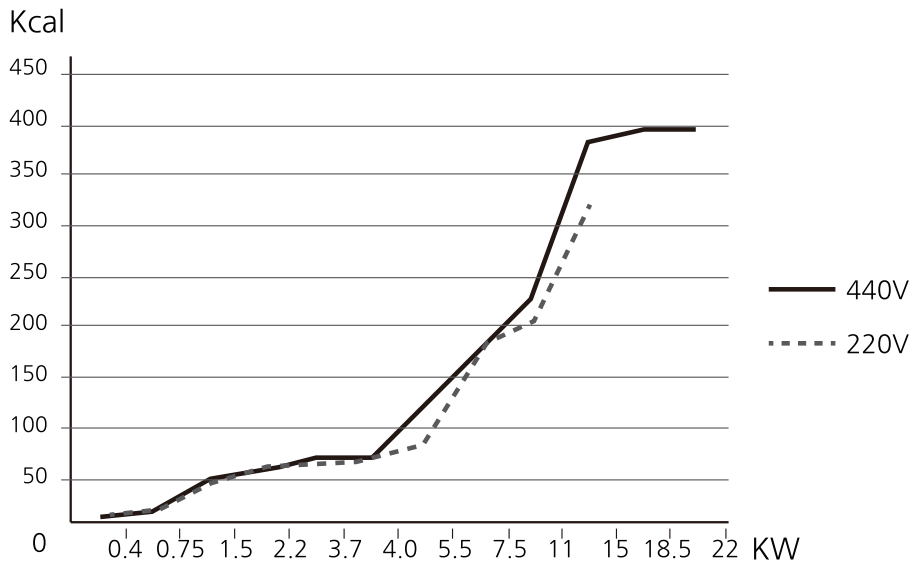

Heat emission data is based on operations with default carrier frequency settings, under normal operating conditions. For detailed information on carrier frequency, refer to [5.16 Operational Noise Settings \(carrier frequency settings\)](#) on page [165](#).

12 Applying Drives to Single-Phase Input Application

12.1 Introduction

LSLV-S100 is a three-phase standard variable frequency drive(VFD). When applying single-phase power to a three-phase VFD, there are several constraints that need to be considered. Standard Pulse-Width-Modulated (PWM) VFDs use a 6-pulse diode rectifier. The 6-pulse rectification results in 360 Hz DC bus ripple when used with a three-phase 60 Hz supply.

However, under single-phase use, the DC bus ripple becomes 120 Hz and the VFDs DC bus circuit is subject to higher stress in order to deliver equivalent power.

Additionally, input currents and harmonics increase beyond those encountered with three-phase input.

Input current distortion of 90% THD and greater can be expected under single-phase input, compared to approximately 40% with three-phase input as indicated in Figure 2.

Therefore, single-phase use requires the three-phase VFD power rating be reduced (derated) to avoid over stressing the rectifier and DC link components.

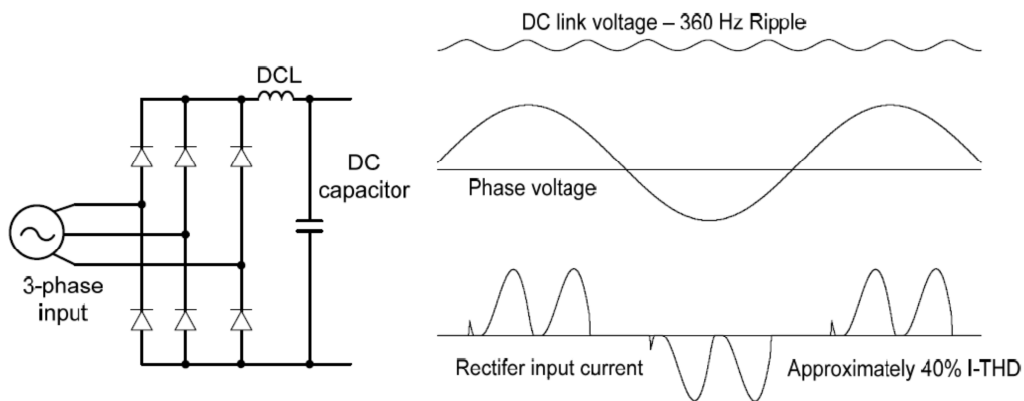

Figure-1 Typical Three-Phase Configuration

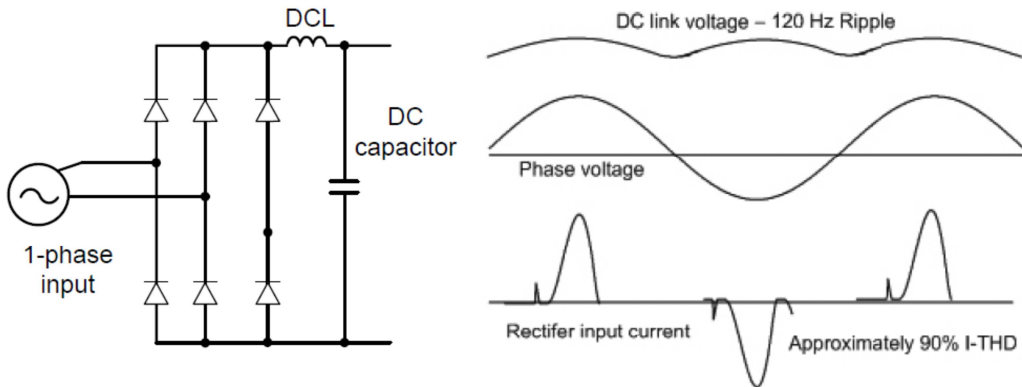

Figure-2 Typical Single-Phase Configuration

12.2 Power(HP), Input Current and Output Current

When using a three-phase VFD with single-phase input, derating the drive's output current and horsepower will be necessary because of the increase in DC bus ripple voltage and current. In addition, the input current through the remaining two phases on the diode bridge converter will approximately double, creating another derating consideration for the VFD. Input current harmonic distortion will increase beyond that with a three-phase supply making the overall input power factor low. Input current distortion over 100% is likely under single-phase conditions without a reactor. Therefore, the reactor is always required. When using a motor that is selected by the three-phase drive rating criteria when using single-phase input, it may result in poor performance, premature drive failure. The selected drive of single-phase current ratings must meet or exceed the motor current rating.

12.3 Input Frequency and Voltage Tolerance

The single-phase current ratings are valid for 60Hz input only. The AC supply voltage must be within the required voltage range of 240/480Vac +10% to -5% to maximize motor power production. Standard product with three-phase voltage input has an allowable range of +10% to -15%. Therefore, a stricter input voltage tolerance of +10 to -5% applies when using the drive with a single-phase supply. The average bus voltage with single-phase input is lower than the equivalent of a three-phase input. Therefore, the maximum output voltage (motor voltage) will be lower with a single-phase input. The minimum input voltage must be no less than 228Vac for 240 volt models and 456Vac for 480 volt models, to ensure motor voltage production of 207Vac and 415Vac, respectively. Thus, if full motor torque must be developed near base speed (full power) it will be necessary to maintain a rigid incoming line voltage so that adequate motor voltage can be produced. Operating a motor at reduced speed (reduced power), or using a motor with a base voltage that is lower than the incoming AC supply rating (ex. 208Vac motor with a 240Vac supply), will also minimize the effect of voltage deprivation. (240VAC Input → 208V motor, 480VAC Input → 400V motor)

Product Warranty

Warranty Information

Fill in this warranty information form and keep this page for future reference or when warranty service may be required.

| | | | |
|----------------------|------------------------|-----------------------------|--|
| Product Name | LSIS Standard Inverter | Date of Installation | |
| Model Name | LSLV-S100 | Warranty Period | |
| Customer Info | Name (or company) | | |
| | Address | | |
| | Contact Info. | | |
| Retailer Info | Name | | |
| | Address | | |
| | Contact info. | | |

Warranty Period

The product warranty covers product malfunctions, under normal operating conditions, for 12 months from the date of installation. If the date of installation is unknown, the product warranty is valid for 18 months from the date of manufacturing. Please note that the product warranty terms may vary depending on purchase or installation contracts.

Warranty Service Information

During the product warranty period, warranty service (free of charge) is provided for product malfunctions caused under normal operating conditions. For warranty service, contact an official LSIS agent or service center.

Non-Warranty Service

A service fee will be incurred for malfunctions in the following cases:

- intentional abuse or negligence
- power supply problems or from other appliances being connected to the product
- acts of nature (fire, flood, earthquake, gas accidents etc.)
- modifications or repair by unauthorized persons
- missing authentic LSIS rating plates
- expired warranty period

Visit Our Website

Visit us at <http://www.lsis.com> for detailed service information.

UL mark



The UL mark applies to products in the United States and Canada. This mark indicates that UL has tested and evaluated the products and determined that the products satisfy the UL standards for product safety. If a product received UL certification, this means that all components inside the product had been certified for UL standards as well.

Suitable for Installation in a compartment Handling Conditioned Air

CE mark



The CE mark indicates that the products carrying this mark comply with European safety and environmental regulations. European standards include the Machinery Directive for machine manufacturers, the Low Voltage Directive for electronics manufacturers and the EMC guidelines for safe noise control.

Low Voltage Directive

We have confirmed that our products comply with the Low Voltage Directive (EN 61800-5-1).

EMC Directive

The Directive defines the requirements for immunity and emissions of electrical equipment used within the European Union. The EMC product standard (EN 61800-3) covers requirements stated for drives.

EAC mark



The EAC (EurAsian Conformity) mark is applied to the products before they are placed on the market of the Eurasian Customs Union member states.

It indicates the compliance of the products with the following technical regulations and requirements of the Eurasian Customs Union:

Technical Regulations of the Customs Union 004/2011 "On safety of low voltage equipment"

Technical Regulations of the Customs Union 020/2011 "On electromagnetic compatibility of technical products"

EMI / RFI POWER LINE FILTERS

LSis inverters, S100 series



RFI FILTERS

THE LS RANGE OF POWER LINE FILTERS **FEB (Standard)** and **FF (Footprint)** SERIES, HAVE BEEN SPECIFICALLY DESIGNED WITH HIGH FREQUENCY **LSis INVERTERS**. THE USE OF LS FILTERS, WITH THE INSTALLATION ADVICE OVERLEAF HELP TO ENSURE TROUBLE FREE USE ALONG SIDE SENSITIVE DEVICES AND COMPLIANCE TO CONDUCTED EMISSION AND IMMUNITY STANDARDS TO EN 50081.

CAUTION

IN CASE OF A LEAKAGE CURRENT PROTECTIVE DEVICES IS USED ON POWER SUPPLY, IT MAY BE FAULT AT POWER-ON OR OFF. IN AVOID THIS CASE, THE SENSE CURRENT OF PROTECTIVE DEVICE SHOULD BE LARGER

RECOMMENDED INSTALLATION INSTRUCTIONS

To conform to the **EMC** directive, it is necessary that these instructions be followed as closely as possible. Follow the usual safety procedures when working with electrical equipment. All electrical connections to the filter, inverter and motor must be made by a qualified electrical technician.

- 1-) Check the filter rating label to ensure that the current, voltage rating and part number are correct.
- 2-) For best results the filter should be fitted as closely as possible to the incoming mains supply of the wiring enclosure, usually directly after the enclosures circuit breaker or supply switch.
- 3-) The back panel of the wiring cabinet of board should be prepared for the mounting dimensions of the filter. Care should be taken to remove any paint etc... from the mounting holes and face area of the panel to ensure the best possible earthing of the filter.
- 4-) Mount the filter securely.
- 5-) Connect the mains supply to the filter terminals marked **LINE**, connect any earth cables to the earth stud provided. Connect the filter terminals marked **LOAD** to the mains input of the inverter using short lengths of appropriate gauge cable.
- 6-) Connect the motor and fit the ferrite core (output chokes) as close to the inverter as possible. Armoured or screened cable should be used with the 3 phase conductors only threaded twice through the center of the ferrite core. The earth conductor should be securely earthed at both inverter and motor ends. The screen should be connected to the enclosure body via and earthed cable gland.
- 7-) Connect any control cables as instructed in the inverter instructions manual.

IT IS IMPORTANT THAT ALL LEAD LENGTHS ARE KEPT AS SHORT AS POSSIBLE AND THAT INCOMING MAINS AND OUTGOING MOTOR CABLES ARE KEPT WELL SEPARATED.

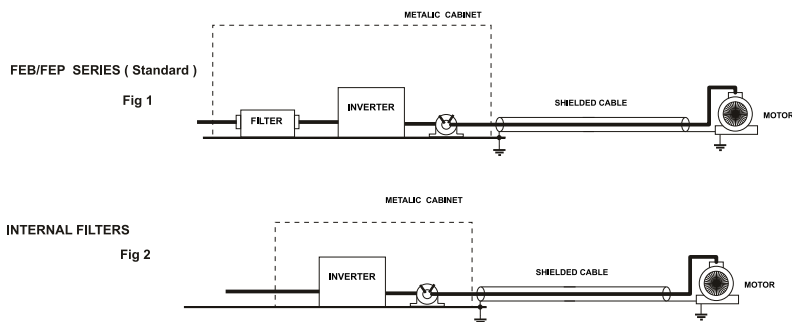

PR0064

| LSLV series / Footprint Filters | | | | | | | | | | | | | | |
|---------------------------------|--------|---------------|---------|---------------|-----------------|---------------------|-------|----|-----------------|-----|--------|-------|------|----------------|
| INVERTER | POWER | CODE | CURRENT | VOLTAGE | LEAKAGE CURRENT | DIMENSIONS L W H | | | MOUNTING Y X | | WEIGHT | MOUNT | FIG. | OUTPUT CHOICES |
| SINGLE PHASE | | | | | | | | | | | | | | |
| MAX. | | | | | | | | | | | | | | |
| LSLV0004S 100-1 | 0.4kW | FFS100-M010-2 | 10A | 250 VAC | 3.5mA | 176 | 71.5 | 45 | 162 | 50 | 0.6Kg | M4 | B | FS-1 |
| LSLV0008S 100-1 | 0.75kW | FFS100-M011-2 | 10A | 250 VAC | 3.5mA | 176 | 103.5 | 45 | 162 | 82 | 0.8Kg | M4 | B | FS-1 |
| LSLV0015S 100-1 | 1.5kW | FFS100-M020-2 | 20A | 250 VAC | 3.5mA | 176 | 103.5 | 45 | 162 | 82 | 0.8Kg | M4 | B | FS-2 |
| LSLV0022S 100-1 | 2.2kW | FFS100-M021-2 | 20A | 250 VAC | 3.5mA | 176 | 143.5 | 45 | 162 | 122 | 0.9Kg | M4 | B | FS-2 |
| THREE PHASE | | | | | | | | | | | | | | |
| NOM. MAX. | | | | | | | | | | | | | | |
| LSLV0004S 100-2 | 0.4kW | FFS100-T006-2 | 6A | 250 VAC | 0.3mA 18mA | 176 | 71.5 | 45 | 162 | 50 | 1.6Kg | M4 | B | FS-2 |
| LSLV0008S 100-2 | 0.75kW | | | | | | | | | | | | | |
| LSLV0015S 100-2 | 1.5kW | FFS100-T012-2 | 12A | 250 VAC | 0.3mA 18mA | 176 | 103.5 | 45 | 162 | 82 | 1.6Kg | M4 | B | FS-2 |
| LSLV0022S 100-2 | 2.2kW | | | | | | | | | | | | | |
| LSLV0037S 100-2 | 3.7kW | FFS100-T020-2 | 20A | 250 VAC | 0.3mA 27mA | 176 | 143.5 | 45 | 162 | 122 | 1.8 Kg | M4 | B | FS-2 |
| LSLV0040S 100-2 | 4kW | | | | | | | | | | | | | |
| THREE PHASE | | | | | | | | | | | | | | |
| NOM. MAX. | | | | | | | | | | | | | | |
| LSLV0004S 100-4 | 0.4kW | FFS100-T006-2 | 6A | 380 - 400 VAC | 0.3mA 18mA | 176 | 71.5 | 45 | 162 | 50 | 1.6Kg | M4 | B | FS-2 |
| LSLV0008S 100-4 | 0.75kW | | | | | | | | | | | | | |
| LSLV0015S 100-4 | 1.5kW | FFS100-T012-2 | 12A | 380 - 400 VAC | 0.3mA 18mA | 176 | 103.5 | 45 | 162 | 82 | 1.6Kg | M4 | B | FS-2 |
| LSLV0022S 100-4 | 2.2kW | | | | | | | | | | | | | |
| LSLV0037S 100-4 | 3.7kW | FFS100-T020-2 | 20A | 380 - 400 VAC | 0.3mA 27mA | 176 | 143.5 | 45 | 162 | 122 | 1.8 Kg | M4 | B | FS-2 |
| LSLV0040S 100-4 | 4kW | | | | | | | | | | | | | |

EN 55011 CLASS B IEC/EN 61800-3 C2

| LSLV series / Standard Filters | | | | | | | | | | | | | | |
|--------------------------------|--------|----------|---------|------------|-----------------|---------------------|----|-----|-----------------|-----|--------|-------|------|----------------|
| INVERTER | POWER | CODE | CURRENT | VOLTAGE | LEAKAGE CURRENT | DIMENSIONS L W H | | | MOUNTING Y X | | WEIGHT | MOUNT | FIG. | OUTPUT CHOICES |
| THREE PHASE | | | | | | | | | | | | | | |
| NOM. MAX. | | | | | | | | | | | | | | |
| LSLV0055S 100-2 | 5.5kW | FLD 3042 | 42A | 220-480VAC | 0.9mA 27mA | 385 | 60 | 150 | 35 | 320 | 2.8Kg | -- | A | FS-2 |
| LSLV0075S 100-2 | 7.5kW | FLD 3055 | 55A | 220-480VAC | 0.9mA 27mA | 385 | 60 | 150 | 35 | 320 | 3.1Kg | -- | A | FS-2 |
| LSLV010S 100-2 | 11kW | FLD 3075 | 75A | 220-480VAC | 0.9mA 27mA | 385 | 60 | 150 | 35 | 320 | 4Kg | -- | A | FS-2 |
| LSLV0150S 100-2 | 15kW | FLD 3100 | 100A | 220-480VAC | 0.9mA 27mA | 380 | 80 | 220 | 55 | 314 | 5.9Kg | -- | A | FS-3 |
| LSLV0185S 100-2 | 18.5kW | FLD 3130 | 130A | 220-480VAC | 0.9mA 27mA | 380 | 80 | 220 | 55 | 314 | 7.9Kg | -- | A | FS-3 |
| LSLV0220S 100-2 | 22kW | | | | | | | | | | | | | |

LSLV0055-0220 S100-2 EN 55011 CLASS A IEC/EN 61800-3 C3

| LSLV series / Internal Filters | | | |
|--------------------------------|--------|------|----------------|
| INVERTER | POWER | FIG. | OUTPUT CHOICES |
| THREE PHASE | | | |
| LSLV0055S 100-4 | 5.5kW | 2 | FS-2 |
| LSLV0075S 100-4 | 7.5kW | 2 | FS-2 |
| LSLV010S 100-4 | 11kW | 2 | FS-2 |
| LSLV0150S 100-4 | 15kW | 2 | FS-3 |
| LSLV0185S 100-4 | 18.5kW | 2 | FS-3 |
| LSLV0220S 100-4 | 22kW | 2 | FS-3 |

EN 55011 CLASS A IEC/EN 61800-3 C3

FEB SERIES (Standard)

FIG.A

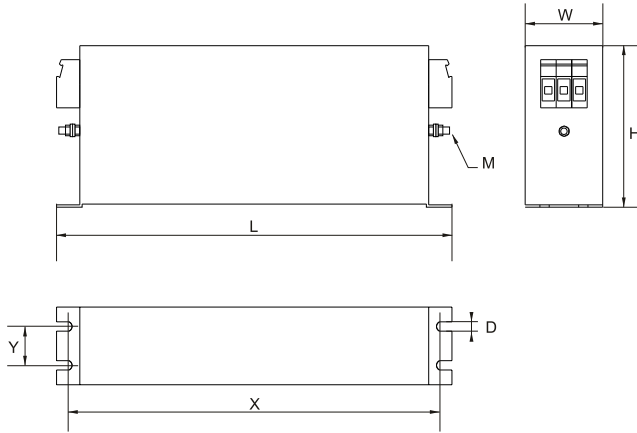

FF SERIES (Footprint)

FIG. B

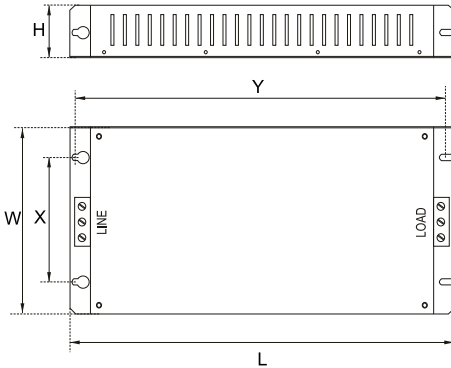

Vector Motor Control Ibérica S.L.
 C/ Mar del Carib, 10
 Pol. Ind. La Torre del Rector
 08130 Santa Perpètua de Mogoda
 (BARCELONA) ESPAÑA
 Tel. (+34) 935 748 206
 Fax (+34) 935 748 248
 info@vmc.es
 www.vmc.es

FS SERIES (output chokes)

| CODE | D | W | H | X | Ø |
|------|------|-----|-----|----------|---|
| FS-1 | 21 | 85 | 50 | 22 | 4 |
| FS-2 | 28,5 | 105 | 62 | 30 | 5 |
| FS-3 | 48 | 150 | 110 | 125 x 30 | 5 |

PR0064

Manual Revision History

Revision History

| No | Date | Edition | Changes |
|----|---------|-------------------------|----------------------|
| 1 | 2013.12 | First Release | - |
| 2 | 2014.11 | 2 nd Edition | S/W Version up(V2.0) |
| 3 | 2015.06 | 3 rd Edition | S/W Version up(V2.3) |
| | | | |
| | | | |
| | | | |
| | | | |

Index

2

| | |
|---|--------|
| 2 square reduction..... | 64 |
| 24 terminal..... | 32, 34 |
| 2nd Motor group...Refer to <i>M2(2nd Motor) group</i> | |
| 2nd Motor Operation..... | 167 |
| 2 nd Operation mode..... | 106 |
| 2 nd command source..... | 107 |
| Shared command (Main Source)..... | 107 |

3

| | |
|-------------------------------|-----|
| 3-phase 200V (0.4~4k W)..... | 342 |
| 3-phase 200V (5.5~15 kW)..... | 343 |
| 3-phase 400V (0.4~4 kW)..... | 344 |
| 3-phase 400V (5.5~22 kW)..... | 345 |
| 3-Wire Operation..... | 130 |

4

| | |
|----------------------------|---------------|
| 4-pole standard motor..... | 341, 344, 345 |
|----------------------------|---------------|

7

| | |
|------------------------|----|
| 7-segment display..... | 44 |
| letters..... | 44 |
| numbers..... | 44 |

A

| | |
|--|--------|
| A terminal (Normally Open)..... | 108 |
| A1/C1/B1 terminal..... | 32 |
| AC power input terminalRefer to <i>R/S/T terminal</i> | |
| Acc/Dec pattern..... | 64, 91 |
| linear pattern..... | 91 |
| S-curve pattern..... | 91 |
| Acc/Dec reference..... | 88 |
| Delta Freq..... | 87 |

| | |
|---|-------------|
| Max Freq..... | 87 |
| Acc/Dec reference frequency..... | 87 |
| Ramp T Mode..... | 87 |
| Acc/Dec stop..... | 94 |
| Acc/Dec time..... | 87 |
| Acc/Dec time switch frequency..... | 91 |
| configuration via multi-function terminal..... | 89 |
| maximum frequency..... | 87 |
| operation frequency..... | 88 |
| accumulated electric energy initialize..... | 177 |
| Ad (Expanded function group)..... | 261 |
| Ad(Advanced) group..... | 46 |
| Add User group | |
| UserGrp SelKey..... | 175 |
| Advanced group..... Refer to <i>Ad(Advanced) group</i> | |
| analog frequency hold..... | 77 |
| Analog Hold..... | 77 |
| Analog Hold..... Refer to <i>analog frequency hold</i> | |
| analog input..... | 30, 46 |
| I2 current input..... | 72 |
| I2 voltage input..... | 74 |
| TI Pulse input..... | 74 |
| V1 voltage input..... | 67 |
| analog input selection switch(SW2)..... | 28, 74 |
| analog output..... | 31, 46 |
| AO terminal..... | 31 |
| pulse output..... | 185 |
| voltage and current output..... | 182 |
| Analog Output..... | 182 |
| analog output selection switch(SW3)..... | 28, 182 |
| AO terminal..... | 31, 85, 182 |
| analog output selection switch(SW3)..... | 28 |
| AP(Application Function group)..... | 285 |
| AP(Application group)..... | 46 |
| Application group..Refer to <i>AP(Application) group</i> | |
| ARM short current fault trip..... Refer to <i>Over Current2</i> | |
| ASCII code..... | 230 |
| asymmetric ground power..... | 36 |

| | |
|---|---------|
| asymmetric ground structure | |
| EMC filter | 36 |
| asynchronous communications system..... | 219 |
| auto restart settings..... | 164 |
| auto torque boost..... | 98, 99 |
| auto tuning | 98, 144 |
| auto tuning..... | 144 |
| All(rotating)..... | 145 |
| All(static)..... | 145 |
| default parameter setting..... | 145 |
| Tr(static)..... | 145 |
| Auto Tuning..... | 257 |
| auxiliary frequency..... | 122 |
| auxiliary frequency reference configuration | 123 |
| auxiliary reference | 122 |
| auxiliary reference gain | 123 |
| configuration | 122 |
| final command frequency calculation | 124 |
| main reference | 122 |

B

| | |
|------------------------------------|---------------------------------|
| B terminal (Normally Closed) | 108 |
| bA(Basic function group) | 256 |
| bA(Basic group)..... | 46 |
| basic configuration diagram | 14 |
| Basic group..... | Refer to <i>bA(Basic) group</i> |
| basic operation..... | 43 |
| bit 108 | |
| bit (Off) | 108 |
| bit (On)..... | 108 |
| bit setting..... | 108 |
| multi-function input setting | 108 |
| multi-function output setting..... | 191 |
| speed search setting..... | 162 |
| stall prevention | 201 |
| Bootlace Ferrule | 33 |
| brake control..... | 179 |
| BR Control | 179 |
| brake engage sequence | 179 |
| brake release sequence..... | 179 |
| brake resistor..... | 26 |
| brake unit..... | 181 |

| | |
|-----------------------------|--|
| braking resistance | |
| braking torque | 359 |
| braking resistors..... | 14 |
| broadcast..... | 227 |
| built-in communication..... | Refer to <i>RS-485</i> <i>BX217</i> , 325 |

C

| | |
|--|-----------------------------|
| cable..... | 10, 21, 22, 23, 24, 27 |
| selection..... | 10, 21, 22, 23, 24, 27 |
| shielded twisted pair | 39 |
| signal(control) cable specifications..... | 11 |
| Cable | |
| Ground Specifications..... | 10 |
| Power I/O Cable Specifications | 10 |
| cable tie | 33 |
| carrier frequency..... | 26, 166 |
| derating..... | 360 |
| factory default | 166 |
| charge indicator | 19, 323, 329 |
| charge lamp | 19 |
| cleaning | 335 |
| CM terminal | 30, 34 |
| CM(communication function group)..... | 280 |
| CM(Communication group)..... | 46 |
| Cn (Control Function group)..... | 266 |
| Cn(Control) group | 46 |
| code number input | 48 |
| command..... | 80 |
| configuration | 80 |
| Command | |
| Cmd Source | 80 |
| command source | |
| keypad | 80 |
| Command source | |
| fwd/rev command terminal | 80 |
| RS-485..... | 82 |
| run command/rotational direction configuration | 81 |
| commercial power source transition | 168 |
| common terminal..... | Refer to <i>EG terminal</i> |

| | |
|--|---|
| communication..... | 219 |
| command loss protective operation | 223 |
| communication address..... | 232 |
| communication line connection..... | 220 |
| communication parameters..... | 220 |
| communication speed | 221 |
| communication standards | 219 |
| memory map..... | 225 |
| PLC | 219 |
| protocol..... | 226 |
| saving parameters defined by communication | 224 |
| setting virtual multi-function input | 223 |
| Communication group..... | <i>CM(Refer to Communication) group</i> |
| compatible common area parameter..... | 235 |
| config (CNF) mode..... | 177 |
| Considerations for the installation | |
| Air Pressure..... | 5 |
| Altitude/Vibration..... | 5 |
| Ambient Humidity..... | 5 |
| Environmental Factors..... | 5 |
| Considerations for the installation | |
| Ambient Temperature..... | 5 |
| contact | |
| A contact | 205 |
| B contact..... | 205 |
| Control group..... | <i>Refer to Cn(Control) group</i> |
| control terminal board wiring..... | 27 |
| cooling fan | |
| fan Operation accumulated time | 196 |
| fan Operation accumulated time initialization..... | 196 |
| Cooling Fan | 169 |
| Fan Control..... | 169 |
| cooling fan malfunction..... | 211 |
| CPU Watch Dog fault trip | 217 |

D

| | |
|-------------------------------|-----------------------------|
| DB resistor | |
| braking resistor circuit..... | 208 |
| DB Warn %ED..... | 208 |
| DB Warn %ED..... | <i>Refer to DB Warn %ED</i> |
| DC braking after start..... | 100 |

| | |
|------------------------------|---------------------------------|
| DC braking after stop..... | 101 |
| DC braking frequency..... | 101 |
| DC link voltage | 121, 154 |
| delta wiring..... | 36, 346 |
| derating | 166 |
| Digital Output..... | 187 |
| digital source..... | 83 |
| disposal..... | 335, 339 |
| dr(Drive group)..... | 46, 251 |
| draw operation..... | 121 |
| Drive group..... | <i>Refer to dr(Drive) group</i> |
| Dwell Operation..... | 133 |
| Acc/Dec dwell frequency..... | 133 |
| acceleration Dwell..... | 133 |
| deceleration Dwell..... | 133 |

E

| | |
|---|--------------------|
| earth leakage breaker..... | 332 |
| EEP Rom Empty..... | 171 |
| EG terminal | 32 |
| electronic thermal overheating protection (ETH) | |
| | 197 |
| EMC filter..... | 36 |
| asymmetric power..... | 36 |
| disable..... | 36 |
| enable | 36 |
| emergency stop fault trip..... | <i>Refer to BX</i> |
| energy buttferring operation..... | 154 |
| energy saving operation | 159 |
| automatic energy saving operation..... | 160 |
| manual energy saving operation..... | 159 |
| error code..... | 230 |
| FE(frame error)..... | 230 |
| IA(illegal data address)..... | 230 |
| ID(illegal data value)..... | 230 |
| IF(illegal function)..... | 230 |
| WM(write mode error)..... | 230 |
| ESC key | 45 |
| [ESC] key configuration | 128 |
| [ESC] key setup..... | 82 |

| | |
|---|----------|
| cancel input | 45 |
| Jog key | 50 |
| local/remote switching..... | 83 |
| multi-function key..... | 82 |
| remote / local operation switching..... | 83 |
| ETH.....Refer to <i>electronic thermal overheating protection (ETH)</i> | |
| E-Thermal..... | 217 |
| Exciting Current | 149 |
| external 24V power terminal.. Refer to <i>24 terminal</i> | |
| external dimensions | |
| 0.8~1.5kW(Single Phase), 1.5~2.2kW(3 Phase)..... | 351 |
| 5.5~22kW(3 phase)..... | 354 |
| External dimensions..... | 349 |
| External dimensions | |
| 0.4kW(Single Phase), 0.4~0.8kW(3 Phase) | 349 |
| External Trip | 217, 324 |
| external trip signal..... | 204 |

F

| | |
|------------------------------------|-----------------------------------|
| factory default | 56, 58, 59 |
| fan trip..... | 211 |
| Fan Trip..... | 217, 325 |
| fan warning..... | 211 |
| Fan Warning..... | 218, 326 |
| fatal | 323 |
| fault..... | 216 |
| fatal | 323 |
| fault/warning list..... | 216 |
| latch..... | 323 |
| level..... | 323 |
| major fault | 217 |
| fault signal output terminal | Refer to <i>A1/C1/B1 terminal</i> |
| FE(FRAME ERROR)..... | 230 |
| ferrite..... | 33 |
| fieldbus..... | 66, 80 |
| communication option | 106 |
| Fieldbus..... | Refer to <i>fieldbus</i> |
| filter time constant..... | 68 |

| | |
|--|---------|
| filter time constant number..... | 107 |
| flux braking..... | 200 |
| free run stop..... | 102 |
| frequency jump | 105 |
| frequency limit | 104 |
| frequency jump..... | 105 |
| frequency upper and lower limit value | 104 |
| maximum/start frequency..... | 104 |
| frequency reference..... | 66, 100 |
| frequency setting | 66 |
| I2 current input | 72 |
| I2 voltage input..... | 74 |
| keypad | 66 |
| RS-485..... | 76 |
| TI Pulse input..... | 74 |
| V1 voltage input..... | 67 |
| variable resistor..... | 57 |
| frequency setting (Pulse train) terminal...Refer to <i>I1 terminal</i> | |
| frequency setting(voltage) terminal.....Refer to <i>V1 terminal</i> | |
| fuse..... | 356 |

G

| | |
|-----------------------------------|-----------------------------|
| ground..... | 23 |
| class 3 ground..... | 23 |
| class 3 ground..... | 23 |
| ground terminal..... | 23 |
| Ground | |
| Ground Cable Specifications | 10 |
| ground fault trip | Refer to <i>Ground Trip</i> |
| Ground Trip..... | 217, 324 |
| ground fault trip | 324 |

H

| | |
|-------------------------|----------|
| half duplex system..... | 219 |
| Heavy Duty | 5 |
| heavy load | 166, 341 |
| hunting..... | 153 |

I

| | |
|---|--|
| I2 | 31, 72 |
| analog input selection switch(SW2) | 31 |
| frequency setting(current/voltage) terminal | 31 |
| IA(illegal data address) | 230 |
| ID(illegal data value) | 230 |
| IF(illegal function) | 230 |
| In Phase Open | 217, 324 |
| In(Input Terminal Block Function group) | 271 |
| In(Input Terminal) group | 46 |
| input and output specification | |
| applied motor | 341 |
| rated input | 341 |
| rated output | 341 |
| input open-phase fault trip | Refer to <i>In Phase Open</i> |
| input phase open | |
| input open-phase protection | 204 |
| input power frequency | 170 |
| input power voltage | 170 |
| input terminal | 30 |
| CM terminal | 30 |
| I2 terminal | 31 |
| P1–P7 terminal | 30 |
| SA terminal | 31 |
| SB terminal | 31 |
| SC terminal | 31 |
| TI terminal | 31 |
| V1 terminal | 31 |
| VR terminal | 30 |
| Input Terminal group | Refer to <i>In(input terminal) group</i> |
| inspection | |
| annual inspection | 336 |
| bi-annual inspection) | 338 |
| installation | 13 |
| basic configuration diagram | 14 |
| Installation flowchart | 13 |
| wiring | 19 |
| Installation | |
| Mounting the Inverter | 15 |

| | |
|-----------------------------|-------------|
| installation considerations | 5, 335, 338 |
| IP 20 | 348 |

J

| | |
|-------------------------|-----|
| Jog Operation | 126 |
| [ESC] key configuration | 50 |
| FWD Jog | 126 |
| Jog frequency | 126 |
| keypad | 128 |
| jump frequency | 105 |

K

| | |
|---------------------|-----|
| keypad | 43 |
| display | 43 |
| operation keys | 43 |
| S/W version | 177 |
| Keypad | |
| Keypad Language | 193 |
| keypad display | 44 |
| keypad key | 45 |
| [▲]/[▼]/[◀]/[▶] key | 45 |
| [ESC] key | 45 |
| [RUN] key | 45 |
| [STOP/RESET] key | 45 |

L

| | |
|------------------------------------|-----------------|
| latch | 323 |
| LCD keypad | 23 |
| LCD brightness/contrast adjustment | 177 |
| wiring length | 33 |
| leakage breaker | 355 |
| level | 323 |
| Lifetime diagnosis of components | |
| lifetime diagnosis for fans | 213 |
| lift-type load | 92, 97, 98, 133 |
| linear pattern | 91 |
| linear V/F pattern operation | 94 |
| linear V/F pattern Operation | |
| base frequency | 95 |

| | |
|--------------------------------------|---------------|
| start frequency..... | 95 |
| local operation | |
| [ESC] key | 83 |
| Local/Remote Mode Switching | 82 |
| remote operation | 83 |
| local Operation..... | 83 |
| locating the installation site..... | 6 |
| location..... | 6 |
| loop..... | 111 |
| loop time..... | 114 |
| Lost Command..... | 217, 325, 326 |
| command loss fault trip warning..... | 217 |
| command loss trip | 217 |
| low voltage | 213 |
| low voltage fault trip..... | 213 |
| low voltage trip 2..... | 216 |
| Low Voltage..... | 217, 324 |
| low voltage fault trip..... | 217 |
| LowLeakage PWM | 166 |
| LS INV 485 protocol | 226 |

M

| | |
|--|---------------|
| M2(2nd Motor Function group)..... | 293 |
| M2(2nd Motor) group | 46 |
| magnetic contactor | 27 |
| Magnetic contactor | 355 |
| maintenance | 335 |
| manual torque boost..... | 97 |
| Master | 219 |
| master inverter..... | 110 |
| master unit..... | 109 |
| megger test..... | 336 |
| micro surge filter | 26 |
| momentary power interruption..... | 154, 162, 163 |
| monitor | 60 |
| monitor registration protocol details..... | 229 |
| Operation State Monitor..... | 193 |
| Operation time monitor..... | 196 |
| motor output voltage adjustment..... | 99 |
| motor protection..... | 197 |

| | |
|--|-----------------------------|
| motor rotational direction..... | 40 |
| motor thermal protection(ETH) | |
| ETH trip..... | 197 |
| E-Thermal..... | 197 |
| mounting bolt | 15 |
| mounting bracket | 17 |
| multi function input terminal | |
| In.65~71 | 273 |
| Px terminal function setting | 273 |
| multi function input terminal | |
| Px Define | 273 |
| multi keypad | |
| Multi KPD..... | 110 |
| multi keypad(Multi-keypad) | |
| slave parameter | 110 |
| multi-drop Link System..... | 219 |
| Multi-function (open collector) output terminal | |
| Multi-function output item1(Q1 Define)..... | 278 |
| Multi-function relay 1 item(Relay 1) | 277 |
| multi-function input terminal | 30 |
| factory default | 30 |
| multi-function input terminal Off filter..... | 107 |
| multi-function input terminal On filter..... | 107 |
| P1~P7..... | Refer |
| multi-function input terminal control | 107 |
| multi-function key..... | 44, 50 |
| [ESC] key | 50 |
| Multi Key Sel | 321 |
| multi-function key options..... | 321 |
| multi-function output | |
| multi-function output terminal delay time settings | 192 |
| multi-function output terminal | |
| multi-function output on/off control | 180 |
| multi-function output terminal and relay settings | 187 |
| multi-function output terminal delay time settings | 192 |
| trip output by multi-function output terminal and relay..... | 191 |
| multi-function(open collector) output terminal | Refer to <i>Q1 terminal</i> |
| multi-keypad..... | 110 |

| | |
|-------------------------------|-----|
| master parameter | 110 |
| multi-keypad) | |
| setting | 110 |
| multi-step frequency | 77 |
| setting | 77 |
| Speed-L/Speed-M/Speed-H | 78 |

N

| | |
|---------------------------------------|----------|
| N- terminal(- DC link terminal) | 26 |
| no motor trip | 216 |
| No Motor Trip | 217, 324 |
| noise | 36, 69 |
| Normal Duty | 5 |
| normal load | 166, 341 |
| Normal PWM | 166 |
| NPN mode(Sink) | 35 |

O

| | |
|---|------------------------------------|
| oOut Phase Open | 324 |
| open-phase protection | 203 |
| Operation frequency | <i>Refer to frequency setting</i> |
| operation group | 249 |
| Operation group | 46 |
| operation noise | 165 |
| carrier frequency | 166 |
| frequency jump | 105 |
| Operation time | 196 |
| operation accumulated time | 196 |
| Operation accumulated time | 196 |
| Operation accumulated time initialization | 196 |
| option trip | 215, Refer to <i>Option Trip-x</i> |
| Option Trip-x | 217 |
| option trip | 217 |
| OU(Output Terminal Block Function group) | 276 |
| OU(Output Terminal) group | 46 |
| Out Phase Open | 217 |
| output block by multi-function terminal | 214 |
| output open-phase fault trip | Refer to <i>Out Phase</i> |

Open

| | |
|-------------------------------------|---|
| output terminal | Refer to <i>R/S/T terminal</i> |
| Output Terminal group | Refer to <i>OU(output terminal) group</i> |
| output/communication terminal | 31 |
| 24 terminal | 32 |
| A1/C1/B1 terminal | 32 |
| AO terminal | 31 |
| EG terminal | 32 |
| Q1 terminal | 32 |
| S+/S-/SG terminal | 32 |
| TO terminal | 32 |
| over current trip | Refer to <i>Over Current1</i> |
| Over Current1 | 217, 323 |
| Over Current2 | 217, 324 |
| Over Heat | 217, 324 |
| over heat fault trip | Refer to <i>Over Heat</i> |
| Over Load | 217, 323 |
| overload fault trip | 217 |
| overload warning | 217, 326 |
| Over Voltage | 217, 324 |
| over voltage trip | Refer to <i>Over Voltage</i> |
| overload | Refer to <i>Over Load</i> |
| overload overload trip | 198 |
| overload warning | 198 |
| overload rate | 166 |
| overload trip | Refer to <i>Over Load</i> |

P

| | |
|--|-----|
| P/Igain | 163 |
| P1+ terminals(+ DC link terminals) | 26 |
| P2P | 109 |
| communication function | 109 |
| master parameter | 109 |
| setting | 109 |
| slave parameter | 109 |
| parameter | 49 |
| display changed parameter | 174 |
| hide parameters | 172 |
| initialization | 171 |
| parameter lock | 173 |

| | |
|---|-----------------------------------|
| parameter setting..... | 49 |
| password..... | 172, 173 |
| read/write/save..... | 171 |
| parameter view lock..... | 172 |
| part names..... | 3 |
| parts illustrated..... | 3 |
| password..... | 172, 246 |
| Password..... | 173 |
| Peripheral devices..... | 355 |
| phase-to-phase voltage..... | 330 |
| PID control..... | 136 |
| basic PID operation..... | 136 |
| configuration..... | 136 |
| Differential time(PID D-Time)..... | 139 |
| integral time(PID I-Time)..... | 139 |
| oscillation..... | 139 |
| Pgain..... | 138 |
| PID control block diagram..... | 141 |
| PID feedback..... | 325 |
| PID Operation Sleep mode..... | 142 |
| PID output..... | 138 |
| PID reference..... | 138 |
| PID Switching..... | 143 |
| Pre-PID Operation..... | 142 |
| PNP mode(Source)..... | 34 |
| PNP/NPN mode selection switch(SW1)..... | 28 |
| NPN mode(Sink)..... | 35 |
| PNP mode(Source)..... | 34 |
| post-installation checklist..... | 38 |
| power consumption..... | 193, 195 |
| power slot..... | 178 |
| power terminal..... | 26 |
| N- terminal..... | 26 |
| P2+/B terminal..... | 26 |
| U/V/W terminal..... | 26 |
| power terminal board wiring..... | 24 |
| power terminals | |
| R/S/T terminals..... | 26 |
| Power-on Run..... | Refer to <i>start at power-on</i> |
| Pr(Protection Function group)..... | 288 |
| Pr(Protection) group..... | 46 |
| pre-exciting time..... | 150 |

| | |
|------------------------------------|--------------------------------------|
| Preinsulated Crimp Terminal..... | 32 |
| press regeneration prevention..... | 181 |
| Press regeneration prevention | |
| P gain/I gain..... | 182 |
| Protection group..... | Refer to <i>Pr(Protection) group</i> |
| protocol..... | 226 |
| LS INV 485 protocol..... | 226 |
| Pulse output terminal..... | Refer to <i>TO terminal</i> |
| PWM..... | 165 |
| frequency modulation..... | 165 |

Q

| | |
|------------------|----------------------------|
| Q1 terminal..... | 32 |
| quantizing..... | Refer to <i>Quantizing</i> |
| Quantizing..... | 69 |
| noise..... | 69 |

R

| | |
|--|---|
| R/S/T terminal..... | 27 |
| R/S/T terminals..... | 26, 329 |
| rated..... | 342 |
| braking resistance rated capacity..... | 359 |
| rated input..... | 342 |
| Rated | |
| rated output..... | 342 |
| rated torque current..... | 183 |
| rating | |
| rated motor current..... | 135 |
| rated motor voltage..... | 144 |
| rated slip frequency..... | 135 |
| rated slip speed..... | 135 |
| reactor..... | 14, 356 |
| regenerated energy..... | 103, 154 |
| remote operation..... | 83 |
| [ESC] key..... | 83 |
| local operation..... | 83 |
| Local/Remote Mode Switching..... | 82 |
| Reset Restart..... | refer to <i>restarting after a trip</i> |
| resonance frequency..... | 105 |

| | |
|---|--------|
| carrier frequency..... | 165 |
| frequency jump..... | 105 |
| restarting after a trip..... | 85 |
| RS-232..... | 219 |
| communication..... | 219 |
| RS-485..... | 219 |
| communication..... | 219 |
| converter..... | 219 |
| integrated communication..... | 76 |
| signal terminal..... | 32, 76 |
| RS-485 signal input terminal..... Refer to <i>S+/S-/SG terminal</i> | |
| run prevention | |
| Fwd..... | 84 |
| Rev..... | 84 |

S

| | |
|--|-----|
| S/W version..... | 177 |
| keypad..... | 177 |
| product..... | 177 |
| S+/S-/SG terminal..... | 32 |
| S100 expansion common area parameter | |
| control area parameter(Read/Write)..... | 243 |
| memory control area parameter(Read/Write)..... | 245 |
| monitor area parameter (read only)..... | 238 |
| SA terminal..... | 31 |
| Safe Operation mode..... | 131 |
| safety information..... | ii |
| safety input power terminal..... Refer to <i>SC terminal</i> | |
| safety inputA terminal..... Refer to <i>SA terminal</i> | |
| Safety inputB terminal..... Refer to <i>SB terminal</i> | |
| SB terminal..... | 31 |
| SC terminal..... | 31 |
| screw specification | |
| control circuit terminal screw | 358 |
| input/output terminal screw..... | 357 |
| screw size..... | 357 |
| screw torque..... | 357 |
| S-curve pattern..... | 91 |
| actual Acc/Dec time..... | 93 |
| sensorless vector control..... | 147 |

| | |
|---|-----|
| configuration..... | 149 |
| Hold Time..... | 150 |
| Igain..... | 150 |
| IM Sensorless..... | 149 |
| Pgain..... | 150 |
| pre-exciting time..... | 150 |
| sensorless vector control operation guide..... | 152 |
| sequence common terminal..... Refer to <i>CM terminal</i> | |
| serge killer..... | 38 |
| setting virtual multi-function input..... | 223 |
| single phase 200V (0.4~2.2 kW)..... | 341 |
| Slave..... | 219 |
| slave inverter..... | 110 |
| slave unit..... | 109 |
| Slip..... | 134 |
| slip compensation operation..... | 134 |
| speed command loss..... | 206 |
| speed search operation..... | 160 |
| Flying Start-1..... | 161 |
| Flying Start-2..... | 161 |
| options..... | 162 |
| P/Igain..... | 163 |
| speed unit selection (Hz or Rpm)..... | 77 |
| Square reduction | |
| Square reduction load..... | 95 |
| V/F pattern Operation..... | 95 |
| stall | |
| bit on/off..... | 201 |
| stall prevention..... | 200 |
| Stall..... | 200 |
| start at power-on..... | 85 |
| start mode..... | 100 |
| acceleration start..... | 100 |
| start after DC braking..... | 100 |
| Station..... | 110 |
| Station ID..... | 232 |
| stop mode..... | 101 |
| DC braking after stop..... | 101 |
| deceleration stop..... | 101 |
| free run stop..... | 102 |
| power braking..... | 103 |

| | |
|---|---|
| storage | 338 |
| Storing Temperature | 5 |
| surge killer | 27 |
| SW1 | Refer to <i>PNP/NPN mode selection switch(SW1)</i> |
| SW2 | Refer to <i>analog input selection switch(SW2)</i> |
| SW3 | Refer to <i>analog output selection switch(SW3)</i> |
| switch | 28 |
| analog input selection switch(SW2) | 28 |
| analog output selection switch(SW3) | 28 |
| PNP/NPN mode selection switch(SW1) | 28 |

T

| | |
|--|-----------------------------|
| target frequency | |
| Cmd Frequency | 251 |
| technical specification | 341 |
| terminal | 108 |
| A terminal | 108, 192 |
| B terminal | 108, 192 |
| terminal for frequency reference setting | Refer to <i>VR terminal</i> |
| test run | 39 |
| TI terminal | 31, 74 |
| time scale | |
| 0.01sec | 88 |
| 0.1sec | 88 |
| 1sec | 88 |
| time scale setting | 87 |
| Timer | 178 |
| TO terminal | 32, 185 |
| torque | 26 |
| torque control | 156 |
| torque reference setting option | 157 |
| torque boost | 97 |
| auto torque boost | 98, 99 |
| manual torque boost | 97 |
| overexcitation | 98 |
| trip | 323 |
| fault/waring list | 216 |
| trip condition monitor | 61 |

| | |
|-----------------------------------|-----|
| trip status reset | 214 |
| Trip | |
| troubleshooting | 327 |
| trip(Trip) | |
| Erase trip history | 177 |
| troubleshooting | 323 |
| other faults | 329 |
| troubleshooting fault trips | 327 |

U

| | |
|---|--|
| U&M mode | 175 |
| U/V/W terminal | 26, 27 |
| U/V/W terminals | 329 |
| UF298 | |
| UF(User Sequence Function) group | 46 |
| under load | |
| under load trip | 209 |
| under load warning | 209 |
| Under Load | 217 |
| underload fault trip | 217 |
| underload trip | 323 |
| underload warning | 217, 326 |
| underload fault trip | Refer to <i>Under Load</i> |
| update | 177, 229 |
| Up-Down Operation | 129 |
| US295 | |
| US(User Sequence) group | 46 |
| user group | 174 |
| delete parameters | 175 |
| user group | |
| parameter registration | 175 |
| user sequence | 111 |
| function block parameter | 114 |
| setting | 111 |
| UF group | 111 |
| US group | 111 |
| user function operation condition | 114 |
| void parameter | 111, 114 |
| User Sequence Function group | Refer to <i>UF(User Sequence Function) group</i> |

| | |
|---|----|
| User Sequence group...Refer to <i>US(user sequence)</i> <i>group</i> | |
| user V/F pattern Operation..... | 96 |
| using the keypad..... | 47 |
| groups/codes..... | 47 |
| Jog Operation key | 50 |
| moving directly to a code | 48 |
| using the using the keypad | |
| parameter setting..... | 49 |

V

| | |
|---|---------|
| V/F control..... | 94 |
| linear V/F pattern operation..... | 94 |
| Square reduction V/F pattern Operation..... | 95 |
| user V/F pattern Operation..... | 96 |
| V1 terminal..... | 31, 67 |
| V2 | |
| analog input selection switch(SW2)..... | 31 |
| V2 input..... | 74 |
| I2 voltage input..... | 74 |
| variable resistor..... | 57 |
| variable torque load..... | 95, 156 |
| voltage drop | 26 |

| | |
|--------------------------------------|-----------------------------|
| voltage/current output terminal..... | Refer to <i>AO terminal</i> |
| VR terminal | 30, 67 |

W

| | |
|------------------------------------|--------|
| warning | 323 |
| Warning | |
| fault/warning list..... | 216 |
| weight | 341 |
| wiring..... | 19 |
| 3 core cable | 26 |
| circuit breaker | 355 |
| control terminal board wiring..... | 27 |
| copper cable..... | 19 |
| cover disassembly..... | 20 |
| ferrite | 33 |
| ground..... | 23 |
| power terminal board wiring..... | 24 |
| re-assembling the covers | 37 |
| signal wiring | 32 |
| torque..... | 19 |
| wiring length..... | 26, 33 |
| WM(write mode error)..... | 230 |